



HAL
open science

Feasibility/Desirability Games for Normal Form Games, Choice Models and Evolutionary Games

Pierre Lescanne

► **To cite this version:**

Pierre Lescanne. Feasibility/Desirability Games for Normal Form Games, Choice Models and Evolutionary Games. 2009. ensl-00408519

HAL Id: ensl-00408519

<https://ens-lyon.hal.science/ensl-00408519>

Preprint submitted on 30 Jul 2009

HAL is a multi-disciplinary open access archive for the deposit and dissemination of scientific research documents, whether they are published or not. The documents may come from teaching and research institutions in France or abroad, or from public or private research centers.

L'archive ouverte pluridisciplinaire **HAL**, est destinée au dépôt et à la diffusion de documents scientifiques de niveau recherche, publiés ou non, émanant des établissements d'enseignement et de recherche français ou étrangers, des laboratoires publics ou privés.

Feasibility/Desirability Games for Normal Form Games, Choice Models and Evolutionary Games

Pierre Lescanne*

Université de Lyon, ENS de Lyon, CNRS (LIP),
46 allée d'Italie, 69364 Lyon, France

Abstract. An abstraction of normal form games is proposed, called *Feasibility/Desirability Games* (or FD Games in short). FD Games can be seen from three points of view: as a new presentation of games in which Nash equilibria can be found, as choice models in microeconomics or as a model of evolution in games.

1 Introduction

Feasibility/Desirability Games (FD games in short) were designed by Le Roux et al. [2006] as a fruitful abstraction of *normal form games*. This abstraction goes beyond the model of matrices, used for normal forms, toward this of directed graphs, which fits better to the true nature of the problem and yields an existence theorem for a natural abstraction of Nash equilibrium.

On another hand, behavioral economics is based on *choice correspondences* which are functions owned by decision makers and aimed to describe human behavior. In Rubinstein [1998], Rubinstein describes the decision process as follows:

an agent ... has to chose an alternative after a process of deliberation in which he answers three questions:

- “What is feasible’?”
- “What is desirable?”
- “What is the best alternative according to the notion of desirability, given the feasibility constraints?”

In this article, we show that if one considers such a game as a unique decision maker and if the relation of the game called *feasible and more desirable choice* is acyclic (i.e., with no path from a node to itself), then the function that yields the abstract Nash equilibria is a choice correspondence. We show how an actual decision maker can be made, namely it can be implemented as a game and the choices he makes are abstract Nash equilibria. Hence we say that a decision maker can be constituted of many agents, which is not a surprise. Think of a

* This research has been supported by Région *Ile de France*.

decision taken by a directorate. The decision is a the rest of a compromise, i.e., an equilibrium.

Salant and Rubinstein [2008] give a sample of choice functions, based on what the authors call a *frame*. We show that FD games are frames, in other words, a game with agents is a good tool to simulate a decision maker. This is also related to what Bernheim and Rangel [2007] call *choice with ancillary functions* and Manzini and Mariotti [2007], *Rational Shortlist Method*. FD games have also interesting connections with evolutionary games. Let us mention that *choice functions* have been studied by Nehring [1997], but despite it speaks about relations, this approach is not directly relevant with the one presented in this paper. See also Alcantud1 and Als-Ferrer [2007] for a somewhat more restricted extension of normal form games.

In this article, we present first in Section 2 the concept of *FD game* followed by this of equilibrium: *abstract Nash equilibrium* (Section 3.1) and its extension called *FD-equilibrium* (Section 3.2). We recall in Section 4 the notion of *choice correspondence* and show its connection with FD-games. Two kinds of choice correspondences are described in Section 5. *Evolutionary games* are described as FD-games in Section 6.

2 FD games

FD games¹ were conceived as extensions of strategic games (Le Roux et al. [2008]) which intend to algebraically formalize games using the minimal set of concepts (Occam’s Razor). They actually implement the three items of the “deliberation process” as presented in Rubinstein [1998, 2006], namely *feasibility*, *desirability*, and *choice of the most desirable among the feasible alternatives*. Like in strategic games, there is a set \mathcal{A} of *agents* and a set \mathcal{S} of *situations*². Each agent moves from a situation to another; but the move can occur only if it is possible for the agent, this is what Rubinstein [1998, 2006] calls *feasibility*. We write it $--\rightarrow_a$. To be precise, $s --\rightarrow_a s'$ means that the move from s to s' is feasible for agent a . An agent can have a desire to go to a situation rather than staying where he is, this is what is called *desirability* in Rubinstein [1998, 2006]; it is written $\cdots\rightarrow_a$. $s \cdots\rightarrow_a s'$ means that agent a who is in situation s desires to go in situation s' . For instance, if the FD-game is a game in normal form and s and s' are strategy profiles, strategy profile s' has a better payoff for him than strategy profile s . Hence, formally, an FD game is a 4-uple $\Gamma = \langle \mathcal{A}, \mathcal{S}, (--\rightarrow_a)_{a \in \mathcal{A}}, (\cdots\rightarrow_a)_{a \in \mathcal{A}} \rangle$.

Example 1. Consider the game with two agents, thin blue and fat red and four situations $(H, H), (H, T), (T, T), (T, H)$. Thin blue agent has feasibility $--\rightarrow$ and desirability $\cdots\rightarrow$, fat red agent has feasibility $---\rightarrow$ and desirability $\cdots\rightarrow$,

¹ Under the name of CP games.

² This corresponds to what is called a strategy profile in strategic games. Sometimes a “situation” is called an “outcome”.



When presented as a strategic game, this game is known as *matching pennies*. The coming example is a game which is not derived from a strategic game.

Example 2 (A quest for the wonderland). Two captains with their ships, which are not sister ships, and their crew look for nice islands to stay. Due to the wind and the different performances of the ships, the eight islands are not equally accessible and some are accessible one way by a ship, but not the other way. Similarly not all the islands are equally nice and the crew may prefer (desire) one over the other. This is represented by the following diagrams.

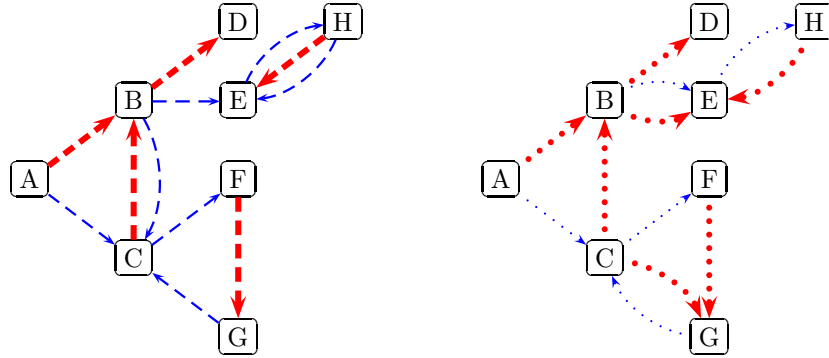

Feasibility of the journeys

Desirability among islands

3 Equilibria

Let us now be a little formal.

3.1 Abstract Nash Equilibrium

A Nash equilibrium is a situation in which no agent can move toward a situation he (she) desires.

Definition 1 (Abstract Nash equilibrium). An abstract Nash equilibrium is a situation s such that: $\forall a \in \mathcal{A}, \forall s' \in \mathcal{S} . s \dashrightarrow_a s' \wedge s \dashrightarrow_a s' \implies s = s'$. This is written $Eq_I^{aN}(s)$ (*aN* stands for abstract Nash).

This suggests a relation \rightarrow_a called *feasible and more desirable choice for a* defined as

$$\rightarrow_a = \dashrightarrow_a \cap \dashrightarrow_a$$

i.e. $s \rightarrow_a s'$ if $s \dashrightarrow_a s'$ and $s \dashrightarrow_a s'$. From these relations, one defines a relation *feasible and more desirable choice* which sums up the *feasible and more desirable choice* of all the agents).

$$\rightarrow = \bigcup_{a \in \mathcal{A}} \rightarrow_a .$$

Definition 2 (Abstract Nash equilibrium, as sink). A situation s is an abstract Nash equilibria if s is a *sink*³ for the *feasible and more desirable choice*, i.e., if $\forall s' \in \mathcal{S}, s \rightarrow s' \Rightarrow s = s'$.

Abstract Nash equilibria can be seen as one of the *feasible most desirable choices*. Actually there is no other situation which is feasible and more desirable.

This is illustrated by the *prisoner's dilemma*.

Example 3 (Prisoner's dilemma). The situations are *Quits (Q)* and *Finks (F)*.

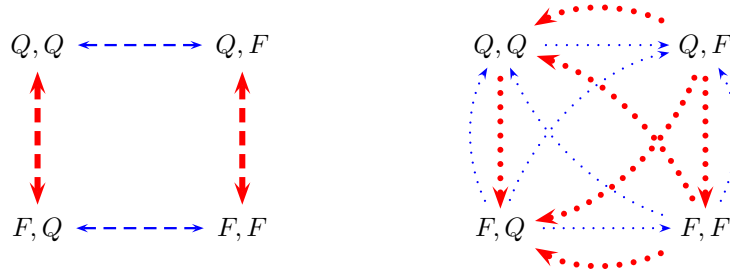

The above graphs represent the *feasibility* (on the left) and the *desirability* (on the right). Vertical arrows for feasibility represent possibilities for the first agent to change his (her) attitude and horizontal arrows are for the second agent. The right digram represents abstractly (i.e., without referring to payoffs that are meaningless in that case) the desires (preferences) of the agents. Both agents prefer (Q, Q) to (F, F) (desire (Q, Q) more than (F, F)), but first agent prefers (F, Q) to (F, F) , (F, Q) to (Q, F) , etc. The graphs below represent the *feasible and more desirable choice* for both prisoners and the (*general*) *feasible and more desirable choice*:

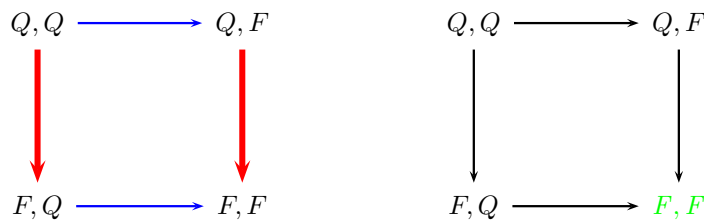

Clearly F, F is a sink for \rightarrow and this is an abstract Nash equilibrium; this means that there is no more desirable choice for the prisoners in this situation. One notices that the change from (F, F) to (Q, Q) which corresponds to a more

³ Given a relation R (or a graph) a *sink* is a node s such that $\forall s', s \rightarrow s' \Rightarrow s = s'$.

desirable choice for both agents is not feasible due to constraints which forces feasibility to be on horizontal or vertical lines only.

The *Battle of the Sexes*, also called *Bach or Stravinsky* or *BoS* (Osborne and Rubinstein [1994], Osborne [2004]) is an example with two abstract Nash equilibria.

Example 4 (Battles of the Sexes). It is given by the two diagrams which describe *feasibility* and *desirability*:

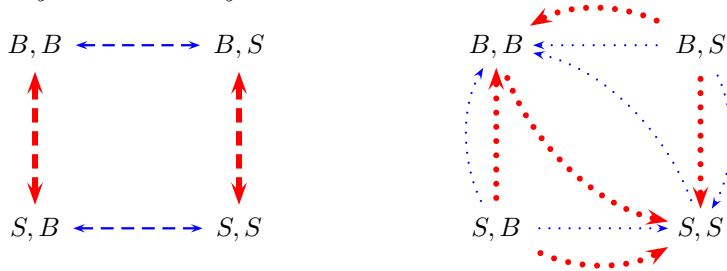

with the *feasible and more desirable choice* for both agents and the *(general) feasible and more desirable choice*:

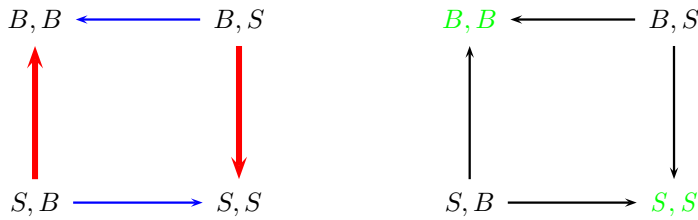

There are two Nash equilibria B, B and S, S .

Example 5 (A quest for the wonderland, the choice). In Example 2 the *feasible and more desirable choice* is given by the following diagram:

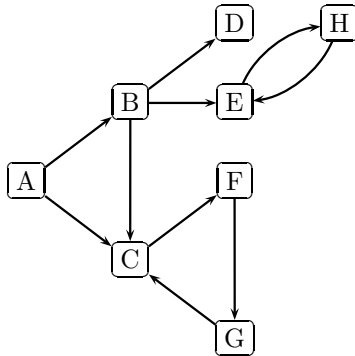

It has an abstract Nash equilibrium, namely D , i.e., one the feasible most desirable choice.

Actually the relation *feasible and more desirable choice* is the relation of interest, but the two relations *feasibility* and *desirability* are essential for two reasons. First they make the connection with strategic games (games in normal forms), in particular *desirability* is what is called *preference* in strategic games (Osborne and Rubinstein [1994]) whereas *feasibility* is an abstraction of the relation that allows moves only along rows, columns, heights, etc. in strategic games. Second they are methodologically important, as they allow thinking models in terms of two relations answering two specific questions: what is feasible? what is desirable?

In algorithmic game theory (Daskalakis et al. [2009], Nisan et al. [2007], Johnson [2007]), Nash equilibria are also sinks for a relation, but the definition of a Nash equilibrium is not given as being a sink. A mixed strategy Nash equilibrium is actually a sink for a completely different relation which is used to find it and which has no connection with the *feasible and more desirable choice*.

3.2 FD equilibria

Let us recall few concepts on directed graphs and strongly connected components.

Strongly connected components. Given a directed graph, a strongly connected component (a SCC in short) is a maximal set of nodes connected in both direction by paths⁴. In other words a SCC is a set of nodes of the directed graph, which are connected by paths (sequences of arcs). Moreover this set is maximal, which means that if one adds a node, then there is a node in the SCC which is not connected to it or the other way around. Fig. 1 shows a graph, its decomposition into strongly connected components and its reduced graph. Actually it has four strongly connected components associated with ●, ■, ★ and ▲. The SCC's form a graph called the *reduced graph*, the nodes of which are the SCC's and the arc of which are as follows: there is an arc from a SCC N to a SCC N' if there are a node n in N , a node n' in N' and an arc $n \rightarrow n'$.

FD equilibria as SCC's. An abstract Nash equilibrium is a sink in the graph of the *feasible and more desirable choice*. We know that abstract Nash equilibria do not exist always, but if we generalize the concept, there exists always an equilibrium. To generalize abstract Nash equilibria, we consider the case where the agents have reached, by the *feasible and more desirable choice*, some kind of end point (end "cluster"), actually an SCC, and are unable to leave it. This corresponds to what people call a *dynamic equilibrium*. Hence a natural extension is to say that a *FD equilibrium* is a sink in the reduced graph, i.e. a SCC with no out arc. The two SCC's associated with ▲ and ★ in Fig. 1 are such sinks in the reduced graph.

⁴ A *path* is a sequence of arcs.

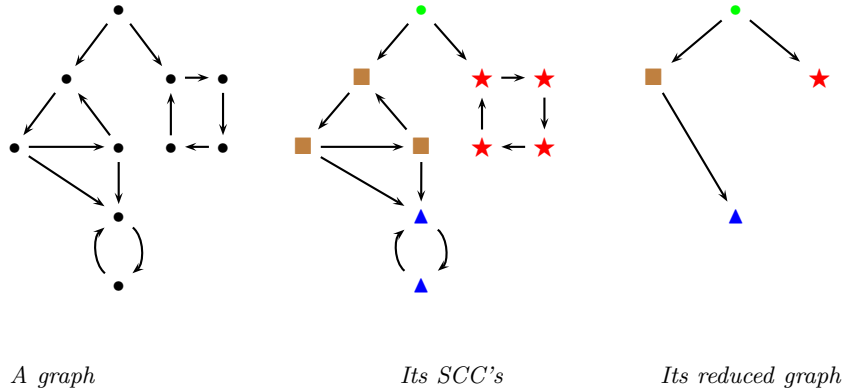
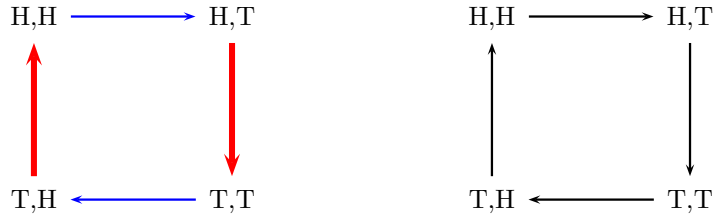

Fig. 1. A graph, its SCC's and, its reduced graph

Examples of FD equilibria

Example 6 (Matching pennies). The *feasible and more desirable choice* for the matching pennies is given by the following diagrams.



Example 7 (Matching pennies with hidden coins). We imagine a new version of *matching pennies* where players have three actions *Presenting the Coin Head up* (H), *Presenting the Coin Tail up* (T) or *Not Presenting the Coin* (N). When both present the same side, fat red wins and thin blue loses and when they both present different sides, thin blue wins and fat red loses. In addition, we assume that when both present nothing they both win and when only one presents nothing they both lose. The game is presented in Fig. 2. The first diagram is *feasibility*, the second diagram is *desirability*⁵, the third diagram is *general feasible and more desirable choice*, and the fourth diagram is the reduced graph of *general feasible and more desirable choice*. One notices two FD equilibria. First, (N, N) which is also an abstract Nash equilibrium and $\{(H, H), (H, T), (T, H), (T, T)\}$ which corresponds to a SCC made of four situations.

Example 8 (Prisoner's dilemma with communications). Adding communication to the prisoner's dilemma is easy. Suppose there is a common knowledge among

⁵ There are two options. You can consider that the desirability is not transitive or you can assume that the arrows that can be deduced by transitivity have been dropped. But this difference is unimportant in what follows.

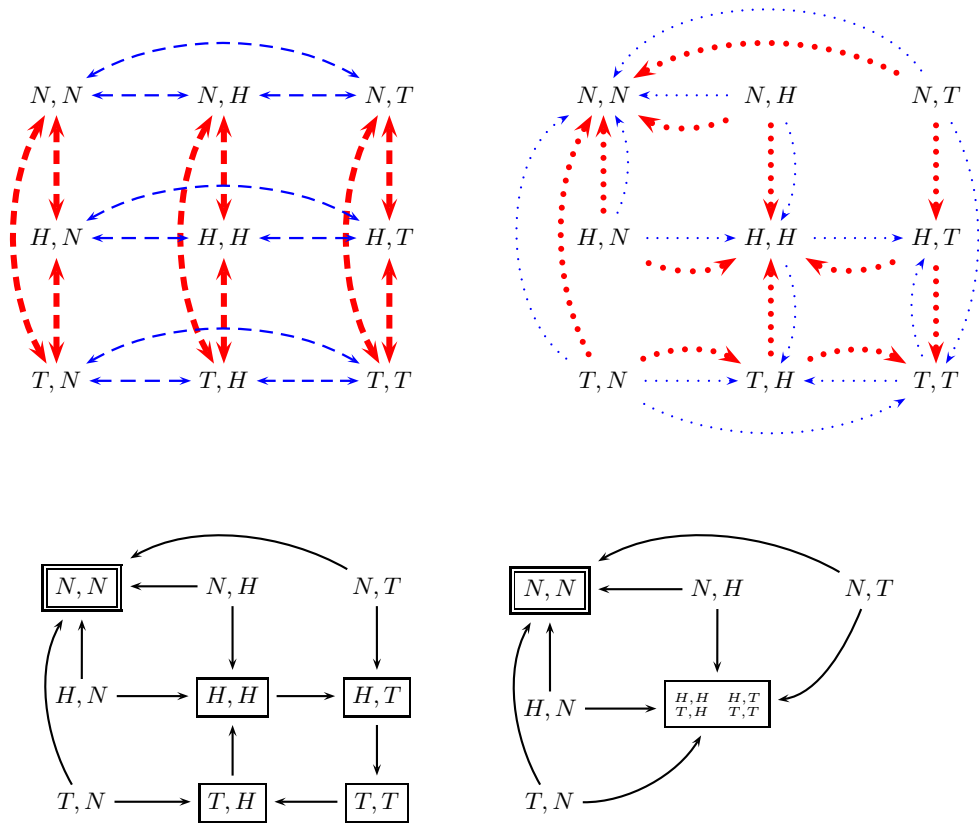
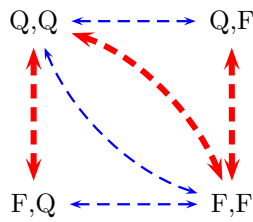
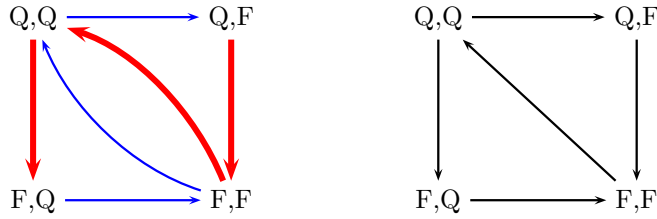

Fig. 2. Matching pennies with hidden coins

the prisoners that if they decide to fink or cooperate they will be put in the same cell and they will be able to communicate. In the feasibility graph this means that one adds two arcs from F, F to Q, Q , one for each prisoner.



and one gets the *feasible and more desirable choice* for both prisoners and the *general feasible and more desirable choice*.



In the last graph there is one SCC, namely $\{(Q, Q), (Q, F), (F, Q), (F, F)\}$. This means that the prisoners will never be able to make their mind.

Example 9 (A quest for the wonderland, the FD equilibria). In Example 2, there are three equilibria (see Fig. 3). In some cases the wonderland is a group of islands. Only island D is a wonderland by itself, therefore the crews can decide to burn their ships or to sink them and stay there. Notice that both crews agree on what a wonderland is and that the decision is made collectively as one decision maker.

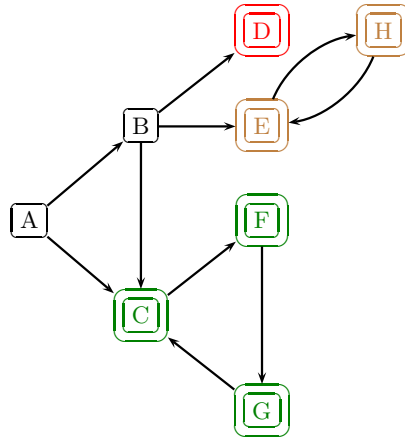

Fig. 3. The three equilibria for the quest for the wonderland

4 Choice

Let us now look at choices. Let us write $\mathcal{P}^*(X)$ the set of non empty subsets of a grand set X . A *choice* is a partial function $C : \mathcal{P}^*(X) \rightarrow X$ with the following constraint⁶:

Condition κ^+ : $C(A) \in A$.

⁶ This means that the choice is consistent because it is an element of the set ; κ stands for *consistency*.

Write $Dom(C)$, the domain of C , i.e. the set of subsets on which C is defined. When we write $C(A)$, we assume $A \in Dom(C)$. There is another constraint on C called *condition* α^+ which says that C is stable on subsets.

Condition α^+ : If $A \subseteq B$ and $C(B) \in A$ then $C(A) = C(B)$.

A *choice correspondence*, written \mathcal{C} , is a partial function, from $\mathcal{P}^*(X)$ to $\mathcal{P}^*(X)$ i.e. such that $\mathcal{C} : \mathcal{P}^*(X) \rightarrow \mathcal{P}^*(X)$, with the constraint:

Condition κ : $\mathcal{C}(A) \subseteq A$.

This means that all the choices $\mathcal{C}(A)$ made by \mathcal{C} are in A . Since \mathcal{C} can be partial, $Dom(\mathcal{C})$ can be a strict subset of X . A set Y of subsets of X is a \cap -*semi-lattice* if the intersection of two subsets in Y is in Y .

Definition 3 (\cap -semi-lattice). A subset Y of $\mathcal{P}^*(X)$ is a \cap -semi-lattice iff $A \in Y$ and $B \in Y$ implies $(A \cap B) \in Y$.

Assume $Dom(\mathcal{C})$ is a \cap -semi-lattice, we can state a new condition on \mathcal{C} .

Condition ι : If $x \in A$ and $x \in \mathcal{C}(B)$ then $x \in \mathcal{C}(A \cap B)$.

In other words $A \cap \mathcal{C}(B) \subseteq \mathcal{C}(A \cap B)$.

Proposition 1. If conditions κ and ι hold then $\mathcal{C}(A) \cap \mathcal{C}(B) \subseteq \mathcal{C}(A \cap B)$.

For choice correspondence, condition α^+ must be changed to take into account that the function does not produce an element but produces a subset.

Condition α : If $A \subseteq B$, if $x \in A$ and if $x \in \mathcal{C}(B)$, then $x \in \mathcal{C}(A)$.

In other words, $A \subseteq B$ implies $A \cap \mathcal{C}(B) \subseteq \mathcal{C}(A)$.

This can be rephrased as “if $A \subseteq B$ then $A \cap \mathcal{C}(B) \subseteq \mathcal{C}(A)$ ”. In particular, if \mathcal{C} produces always a singleton i.e. $\mathcal{C}(A) = \{c_A\}$, which means that \mathcal{C} is a choice function, then *condition* α says that if $x \in A$ and if $x \in \{c_B\}$ then $x \in \{c_A\}$, in other words if $x \in A$ and if $x = c_B$ then $x = c_A$ which means exactly if $c_B \in A$ then $c_A = c_B$, which is condition α^+ . The following proposition can be stated.

Proposition 2. Assume $Dom(\mathcal{C})$ is a \cap -semi-lattice, then

1. \mathcal{C} satisfies condition ι implies \mathcal{C} satisfies condition α .
2. \mathcal{C} satisfies condition κ and condition α implies \mathcal{C} satisfies condition ι .

Proof. For 1., if $A \subseteq B$ then $A \cap B = A$, then condition ι implies condition α .

For 2., one has $A \cap B \subseteq B$, condition κ can be rephrased as $B \cap \mathcal{C}(B) = \mathcal{C}(B)$ and condition α is $A \cap B \cap \mathcal{C}(B) \subseteq \mathcal{C}(A \cap B)$ which is condition ι .

5 Acyclic Relations as Choice Correspondences

In this section we are going to show that any relation (not necessary an order) can be used as a choice correspondence. The only requirement is the existence of a sink. Such a relation is naturally given by a *feasible and more desirable choice*.

Now we abstract the presentation of the previous sections, by considering only the pair $\langle \mathcal{S}, \rightarrow \rangle$. One may consider \mathcal{S} as a set of situations and \rightarrow as a *feasible and more desirable choice*. In other words, we forget about feasibility and desirability for a while and retain only \rightarrow . From a choice point of view, \mathcal{S} is the set of *alternatives*. A *choice maker* is then a combination of agents participating in an FD game. $\mathcal{C}_{\rightarrow}$ is the choice correspondence for the relation \rightarrow . It associates with A the set of sinks in A for the relation \rightarrow , more precisely:

$$\mathcal{C}_{\rightarrow}(A) = \{s \in A \mid \forall s' \in A, s \rightarrow s' \Rightarrow s = s'\}.$$

In Fig. 4, $\mathcal{C}_{\rightarrow}(A)$ is made of the red triangles and the blue square and $\mathcal{C}_{\rightarrow}(B)$ is made of the green circles and the blue square.

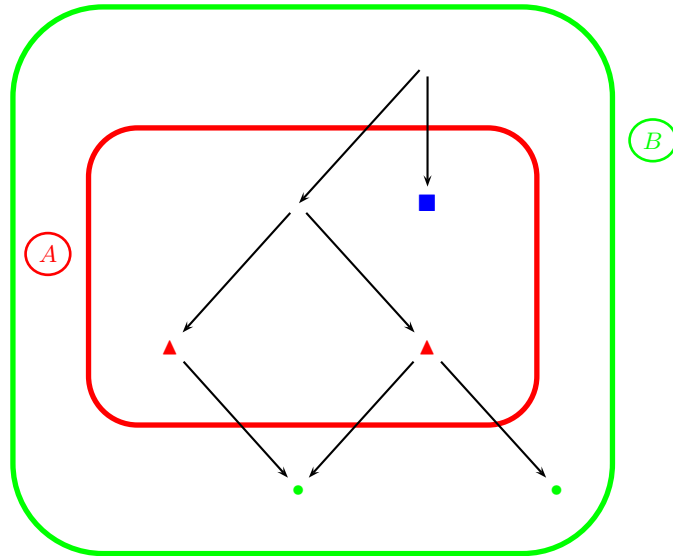

Fig. 4. A relation and two choice correspondences

Claim. $\mathcal{C}_{\rightarrow}$ is a choice correspondence. Its domain is

$$\text{Dom}(\mathcal{C}_{\rightarrow}) = \{A \in \mathcal{P}^*(X) \mid \exists s \in A, \forall s' \in A, s \rightarrow s' \Rightarrow s = s'\}.$$

In other words, the domain of $\mathcal{C}_{\rightarrow}$ is the set of sets which have at least a sink situation.

Claim. If \rightarrow is acyclic and B is finite and not empty then $\mathcal{C}_{\rightarrow}(B)$ is finite and non empty, in other words, $\mathcal{D}om(\mathcal{C}_{\rightarrow}) = \mathcal{P}^*(X)$.

Proof. A finite acyclic relation has always a sink.

Claim. $\mathcal{C}_{\rightarrow}$ fulfills condition κ , i.e. $\mathcal{C}_{\rightarrow}(A) \subseteq A$.

Claim. If \rightarrow is acyclic, then $\mathcal{C}_{\rightarrow}$ fulfills condition α .

Proof. If $A \subseteq B$, condition $\forall s \in B, s \rightarrow s' \Rightarrow s = s'$ is stronger than $\forall s \in A, s \rightarrow s' \Rightarrow s = s'$ hence $s \in A$ and $s \in \mathcal{C}_{\rightarrow}(B)$ imply $s \in \mathcal{C}_{\rightarrow}(A)$.

This is illustrated by the diagram of Fig. 4. The blue square belongs to A and is a sink in B then it is also a sink in A , in other words, $\blacksquare \in A$ and $\blacksquare \in \mathcal{C}_{\rightarrow}(B)$ implies $\blacksquare \in \mathcal{C}_{\rightarrow}(A)$.

6 Evolutionary Dynamic Games

In Le Roux et al. [2008], we presented a game called *Blink and you lose* due to René Vestergaard.

6.1 Blink and you lose

Blink and you lose is a game played on a simple graph with two undifferentiated tokens. There are three positions:

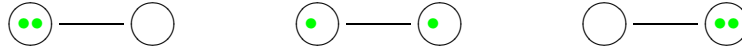

There are two players, *Left* and *Right*. The leftmost position above is the winning position for *Left* and the rightmost position is the winning position for *Right*. In other words, the one who owns both token is the winner. Let us call the positions L , C , and R respectively. One plays by taking a token on the opposite node. The game has four tactics.

A first tactic: Foresight A player realizes that she can win by taking the opponent's token faster than the opponent can react, i.e., player *Left* can convert C into L by outpacing player *Right*. Player *Right*, in turn, can convert C into R . This version of the game has two singleton equilibria: L and R . This is described by the following feasibility.

$$L \xleftarrow{\text{red dashed}} C \xrightarrow{\text{blue dashed}} R$$

desirability is

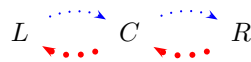

where $\dots \blacktriangleright$ is the desirability for *Left* and $\dots \blacktriangleright$ is the desirability for *Right*. The general feasible and more desirable choice is then:

$$L \longleftarrow C \longrightarrow R$$

and one sees that there are two equilibria: namely L and R , which means that players have taken both token and keep them.

A second tactic: Hindsight A player, say *Left*, analyzes what would happen if she does not act. In case *Right* acts, the game would end up in R and *Left* loses. As we all know, people hate to lose so they have an aversion for a losing position. Actually *Left* concludes that she could have prevented the R outcome by acting. In other words, it is within *Left*'s power to convert R into C . Similarly for player *Right* from L to C .

$$L \dashrightarrow C \dashleftarrow R$$

We get the following general feasible and more desirable choice:

$$L \longrightarrow C \longleftarrow R$$

where C is a singleton equilibrium or an Abstract Nash Equilibrium.

A third tactic: Omniscient The players have both hindsight and foresight, resulting in an FD game

$$L \overset{\curvearrowright}{\dashrightarrow} C \overset{\curvearrowright}{\dashrightarrow} R$$

with one change-of-mind equilibrium covering all outcomes thus, no singleton equilibrium (or Abstract Nash Equilibrium) exists.

$$L \overset{\curvearrowright}{\dashrightarrow} C \overset{\curvearrowright}{\dashrightarrow} R$$

A fourth tactic: Defeatism One of the player, say *Left*, acknowledges that she will be outperformed by the other (*Right* in this case). She is so terrified by her opponent that she returns the token when she has it.⁷ This yields the following feasibility:

$$L \dashrightarrow C \dashrightarrow R$$

We get the following general feasible and more desirable choice

$$L \longrightarrow C \longrightarrow R$$

where R is a singleton equilibrium or an Abstract Nash Equilibrium.

⁷ This strategy was not presented in Le Roux et al. [2008].

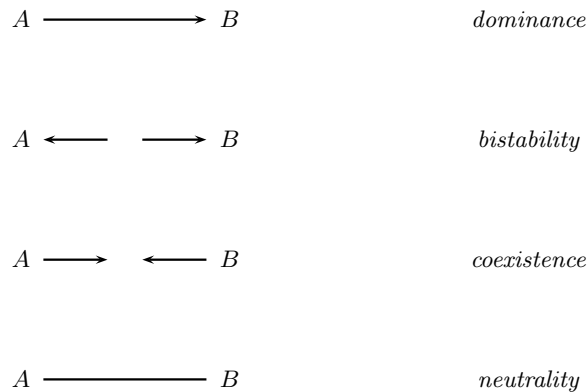

Fig. 5. Evolutionary game dynamics (after Nowak and Sigmund)

6.2 Blink and you loose and evolutionary games

Nowak and Sigmund [2004] present outcomes of evolutionary games of two strategies, like in Fig. 5. They call the first outcome: *dominance*, (A vanishes, if B is the best reply to both A and B), for us this is the tactic *defeatism* in *Blink and you loose*. They call the second outcome *bistability* (either A or B vanishes, depending on the initial mixture, if each strategy is the best response to itself), for us this is the tactic *foresight*. They call the third outcome: *coexistence* (A and B coexist in stable proportion, if each strategy is the best response to the other), for us this is the tactic *hindsight*. They call the fourth outcome: *neutrality* (the frequencies of A and B are only subject to random drift, if each strategy fares as well as the other for any composition of the population and exhibit the same pictures), for this corresponds to the tactic *omnisight*.

6.3 Evolution of FD games

FD games are a natural frame for evolution of games, especially of normal form games. First recall that they abstract normal form games. Second they describe accurately the process of evolution. Consider a sequence of games describing an evolution. Suppose that at step n player a is at a situation s_n . At step $n + 1$, he will move, if this is possible, to a situation s_{n+1} he can move to (feasible) and he wants to (desirable). Therefore he will naturally follow an arc of the relation *feasible and more desirable choice*. There will be two kinds of interesting outcomes: either at some step, players reach a situation they cannot proceed further, this is an abstract Nash equilibrium, or players reach a strongly

connected component for the relation *feasible and more desirable choice*, in which the move forever without being able to leave it, this is an FD equilibrium.

6.4 Matching pennies with hidden coins

One can consider the evolution of the game of Fig. 2. One sees that it can have two evolutions, either to N, N which is an abstract Nash equilibrium or to the SCC which is an FD-equilibrium.

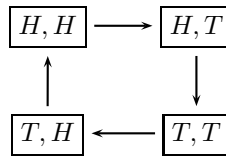

Acknowledgment I would like to thanks Franck Delaplace, Stéphane Le Roux and René Vestergaard for discussions and suggestions.

7 Conclusion

This paper has shown the connection between game theory (more specially FD game theory which covers strategic game theory) choice models and evolutionary games, namely we have shown that if the game has only abstract Nash equilibria, the function that yields the set of all the abstract Nash equilibria is a choice correspondence.

Bibliography

- Jos C. R. Alcantud¹ and Carlos Als-Ferrer. Nash equilibria for non-binary choice rules. *International Journal of Game Theory*, 35(3):455–464, 2007.
- B. Bernheim and A. Rangel. Toward choice-theoretical foundations for behavioral welfare economics. *American Economic Review Papers and Proceedings*, 97:464–470, 2007.
- Contantinos Daskalakis, Paul W. Golberg, and Christos H. Papadimitriou. The complexity of computing a Nash equilibrium. *Communications of the ACM*, 52(2):89–97, 2009.
- David S. Johnson. The NP-completeness column: Finding needles in haystacks. *ACM Transactions on Algorithms*, 3(2), May 2007.
- Stéphane Le Roux, Pierre Lescanne, and René Vestergaard. A discrete Nash theorem with quadratic complexity and dynamic equilibria. Research Report IS-RR-2006-006, JAIST, May 2006.
- Stéphane Le Roux, Pierre Lescanne, and René Vestergaard. Conversion/Preference games. Technical report, PRUNEL, Publications de la Recherche Universitaire de l'ENS de Lyon ENSL - ENS Lyon, 2008.
<http://prunel.ccsd.cnrs.fr/ensl-00333708/fr/>.
- P. Manzini and M. Mariotti. Sequential rationalizable choices. *The American Economic Review*, 97(5):1824–1839, December 2007.
- K. Nehring. Rational choice and revealed preference without binariness. *Soc. Choice Welfare*, 14:403–425, 1997.
- Noam Nisan, Tim Roughgarden, Éva Tardos, and Vijay V. Vazirani, editors. *Algorithmic Game Theory*. Cambridge University Press, 2007.
- M. A. Nowak and K. Sigmund. Evolutionary dynamics of biological games. *Science*, 3003:793–798, February 2004.
- M. J. Osborne and A. Rubinstein. *A Course in Game Theory*. The MIT Press, Cambridge, Massachusetts, 1994.
- Martin J. Osborne. *An Introduction to Game Theory*. Oxford, 2004. ISBN 0195128958.
- Ariel Rubinstein. *Lecture Notes in Microeconomic Theory*. Princeton University Press, 2006.
- Ariel Rubinstein. *Modeling Bounded Rationality*. MIT Press, 1998.
- Yuval Salant and Ariel Rubinstein. (A, f) : Choice with frames. *Review of Economic Studies*, 75:1287–1296, 2008.

Notions on directed graphs

In this section we recall notions on relations which are also called directed oriented graphs and operations on them.

Graphs or relations A *directed graph* or a *relation* R on A is a subset of $A \times A$.

The elements of A are called the *nodes* of the graph and the pairs of R are called the arcs of the graph. One writes $x R y$ if $(x, y) \in R$.

A relation is transitive if $x R y$ and $y R z$ implies $x R z$.

A relation is reflexive if $x R x$ for all x .

The transitive closure of a graph or of a relation R is the least relation R^+ which contains R .

A directed acyclic graph is a graph such that there exists no path from x to x , in other words, there is no x , such that $x R^+ x$.

The transitive and reflexive closure of a relation R is the least transitive and reflexive relation R^* which contains R .

Why is this article published only on the arXiv?

This paper does present deep results from the mathematical point of view, like all the papers quoted in the bibliography. Like previous ones [Le Roux et al., 2006, Le Roux et al., 2008] it has been submitted to several journals and has been rejected without having been actually read by any referee or editors, with only subjective arguments. It should be interesting to know what kinds of sociological arguments lie behind this rejection. My view is that actually scientists are reluctant to new ideas and new paradigms. Thank to the arXiv system, this research can be made available to a large community and to the future generation.