



HAL
open science

On rationally integrable planar dual multibilliards and piecewise smooth projective billiards

Alexey Glutsyuk

► **To cite this version:**

Alexey Glutsyuk. On rationally integrable planar dual multibilliards and piecewise smooth projective billiards. 2023. ensl-03925877v1

HAL Id: ensl-03925877

<https://ens-lyon.hal.science/ensl-03925877v1>

Preprint submitted on 5 Jan 2023 (v1), last revised 16 Nov 2024 (v3)

HAL is a multi-disciplinary open access archive for the deposit and dissemination of scientific research documents, whether they are published or not. The documents may come from teaching and research institutions in France or abroad, or from public or private research centers.

L'archive ouverte pluridisciplinaire **HAL**, est destinée au dépôt et à la diffusion de documents scientifiques de niveau recherche, publiés ou non, émanant des établissements d'enseignement et de recherche français ou étrangers, des laboratoires publics ou privés.

On rationally integrable planar dual multibilliards and piecewise smooth projective billiards

Alexey Glutsyuk^{*†‡§}

January 1, 2023

Abstract

A planar *projective billiard* is a planar curve C equipped with a transversal line field. It defines reflection of lines from C . Its projective dual is a *dual billiard*: a curve $\gamma \subset \mathbb{RP}^2$ equipped with a family of non-trivial projective involutions acting on its projective tangent lines and fixing the tangency points. Projective and dual billiards were introduced by S.Tabachnikov. He stated the following conjecture generalizing the famous Birkhoff Conjecture on integrable billiards to dual and projective billiards. *Let a dual billiard γ be strictly convex and closed, and let its outer neighborhood admit a foliation by closed curves (including γ) such that the involution of each tangent line to γ permutes its intersection points with every leaf. Then γ and the leaves are conics forming a pencil.* In a recent paper the author proved this conjecture under the *rational integrability* assumption: existence of a non-constant rational function (*integral*) whose restriction to tangent lines is invariant under their involutions. He has also shown that if γ is not closed, then it is still a conic, but the dual billiard structure needs not be defined by a pencil. He classified all the rationally integrable dual billiard structures (with singularities) on conic. In the present paper we give classification of rationally integrable *dual multibilliards*: collections of dual billiards and points Q_j (called *vertices*) equipped with a family of projective involutions acting on lines through Q_j from an open subset in \mathbb{RP}^1 . As an application, we get classification of *piecewise smooth projective billiards* whose billiard flow has a non-constant first *integral* that is a *rational 0-homogeneous function of the velocity*.

*CNRS, UMR 5669 (UMPA, ENS de Lyon), France. E-mail: aglutsyu@ens-lyon.fr

†HSE University, Moscow, Russia

‡Kharkevich Institute for Information Transmission Problems (IITP, RAS), Moscow

§Supported by part by RFBR grant 20-01-00420

Contents

1	Introduction	3
1.1	Introduction, brief description of main results and plan of the paper	3
1.2	Previous results 1: classification of real and complex rationally integral dual billiards on one curve	9
1.3	Previous results 2: classification of rationally 0-homogeneously integrable projective billiards on one curve	10
1.4	Main results: classification of rationally integrable planar dual multibilliards with C^4 -smooth curves	13
1.5	Application: classification of rationally 0-homogeneously integrable piecewise C^4 -smooth projective billiards	21
1.6	Plan of proofs of main results	28
1.7	Historical remarks	31
2	Rationally integrable dual multibilliards. Proofs of Theorems 1.25, 1.26, 1.31, 1.27	33
2.1	Rational integrability of pencil type multibilliards	33
2.2	Foliation by level curves of rational integral. Proof of Theorems 1.25 and 1.26	37
2.3	Dual billiard structures at vertices. Birationality and types of involutions	43
2.4	Pencil case. Proof of Theorem 1.26	50
2.5	Exotic multibilliards. Proof of Theorem 1.31	53
2.6	Admissible vertices of real pencils of conics. Proof of Proposition 1.24	58
3	Rationally 0-homogeneously integrable piecewise smooth projective billiards. Proof of Theorems 1.38, 1.39, 1.45	60
3.1	Duality between projective billiards and dual multibilliards. Correspondence between integrals	60
3.2	Case of dual pencil. Proof of Theorems 1.38, 1.39, 1.40	62
3.3	Exotic projective billiards. Proof of Theorem 1.45	63
4	Integrals of dual pencil type billiards: examples of degrees 4 and 12. Proof of Theorems 1.28, 1.41 and Lemma 1.42	66
4.1	Multibilliards of pencil type. Proof of Theorem 1.28	66
4.2	Dual pencil type projective billiards. Proof of Theorem 1.41 and Lemma 1.42	69

4.3	Generic dual pencil type projective billiards with integrals of degrees 4 and 12	71
4.4	Semi-(pseudo-) Euclidean billiards with integrals of different degrees	73

1 Introduction

1.1 Introduction, brief description of main results and plan of the paper

Consider a planar billiard $\Omega \subset \mathbb{R}^2$ bounded by a C^2 -smooth strictly convex closed curve. Recall that its *caustic* is a curve $S \subset \mathbb{R}^2$ such that each tangent line to S is reflected from the boundary $\partial\Omega$ to a line tangent to S . A billiard is *Birkhoff caustic-integrable*, if some inner neighborhood of its boundary is foliated by closed caustics, with boundary being a leaf of the foliation. This is the case in an elliptic billiard, where confocal ellipses form a foliation by closed caustics of a domain adjacent to the boundary ellipse. The famous open Birkhoff Conjecture states that *the only integrable billiards are ellipses*. See its brief survey in Subsection 1.7. S.Tabachnikov suggested its generalization to projective billiards introduced by himself in 1997 in [35]. See the following definition and conjecture.

Definition 1.1 [35] A *projective billiard* is a smooth planar curve $C \subset \mathbb{R}^2$ equipped with a transversal line field \mathcal{N} . For every $Q \in C$ the *projective billiard reflection involution* at Q acts on the space of lines through Q as the affine involution $\mathbb{R}^2 \rightarrow \mathbb{R}^2$ that fixes the points of the tangent line to C at Q , preserves the line $\mathcal{N}(Q)$ and acts on $\mathcal{N}(Q)$ as the central symmetry with respect to the point¹ Q . In the case, when C is a strictly convex closed curve, the *projective billiard map* acts on the *phase cylinder*: the space of oriented lines intersecting C . It sends an oriented line to its image under the above reflection involution at its last point of intersection with C in the sense of orientation. See Fig. 1.

Example 1.2 A usual Euclidean planar billiard is a projective billiard with transversal line field being normal line field. Each billiard in a complete Riemannian surface Σ of non-zero constant curvature (i.e., in sphere S^2 and

¹In other words, two lines a, b through Q are permuted by reflection at Q , if and only if the quadruple of lines $T_Q C, \mathcal{N}(Q), a, b$ is harmonic: there exists a projective involution of the space \mathbb{RP}^1 of lines through Q that fixes $T_Q C, \mathcal{N}(Q)$ and permutes a, b .

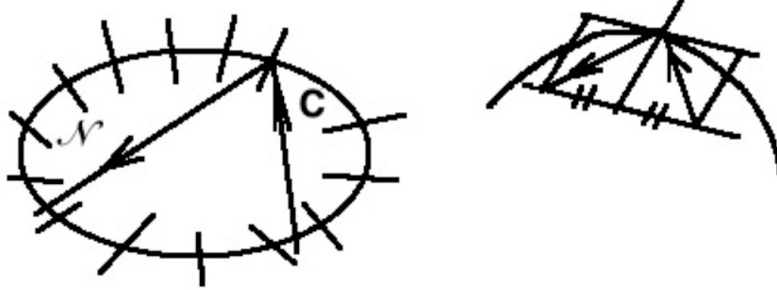

Figure 1: The projective billiard reflection.

in hyperbolic plane \mathbb{H}^2) also can be seen as a projective billiard, see [35]. Namely, consider $\Sigma = S^2$ as the unit sphere in the Euclidean space \mathbb{R}^3 , and $\Sigma = \mathbb{H}^2$ as the semi-pseudo-sphere $\{x_1^2 + x_2^2 - x_3^2 = -1, x_3 > 0\}$ in the Minkowski space \mathbb{R}^3 equipped with the form $dx_1^2 + dx_2^2 - dx_3^2$. The billiard in a domain $\Omega \subset \Sigma_+ := \Sigma \cap \{x_3 > 0\}$ is defined by reflection of geodesics from its boundary. The tautological projection $\pi : \mathbb{R}^3 \setminus \{0\} \rightarrow \mathbb{RP}^2$ sends Ω diffeomorphically to a domain in the affine chart $\{x_3 = 1\}$. It sends billiard orbits in Ω to orbits of the projective billiard on $C = \pi(\partial\Omega)$ with the transversal line field \mathcal{N} on C being the image of the normal line field to $\partial\Omega$ under the differential $d\pi$.

The notion of caustic (integrability) of a projective billiard repeats the above notions for the usual billiards. **Tabachnikov Conjecture** states that *if a projective billiard is integrable, then the billiard boundary and the caustics are conics, whose dual conics form a pencil*. To study it, Tabachnikov introduced the dual objects to projective billiards, the so-called dual billiards, and stated the dual version of his conjecture for them, see the next definition and conjecture.

Definition 1.3 [27, definitions 1.6, 1.17] A *real (complex) dual billiard* is a smooth (holomorphic) curve $\gamma \subset \mathbb{RP}^2(\mathbb{CP}^2)$ where for each point $P \in \gamma$ the real (complex) projective line L_P tangent to γ at P is equipped with a projective involution $\sigma_P : L_P \rightarrow L_P$ fixing P ; the family of involutions (called the *dual billiard structure*) is parametrized by tangency points P .

The **dual Tabachnikov Conjecture** deals with a strictly convex closed curve $\gamma \subset \mathbb{RP}^2$ equipped with a dual billiard structure such that *an outer neighborhood of the curve γ admits a foliation by strictly convex closed*

curves, including γ , such that each involution σ_P , $P \in \gamma$, permutes the intersection points of the line L_P with each individual leaf. It states that under this assumption (called *integrability condition*) the curve γ and the leaves of the foliation are conics forming a pencil. It implies that the dual billiard structure on γ is of pencil type, see the next definition.

Definition 1.4 [27, example 1.14] A dual billiard is of *pencil type*, if the underlying curve γ is a (punctured) conic and there exists a pencil of conics containing γ such that for every $P \in \gamma$ the involution σ_P permutes the intersection points of the line L_P with each conic of the pencil (or fixes the intersection point, if it is unique). As was observed by S.Tabachnikov, conversely, for every conic γ and every pencil containing γ , for every P in the conic γ punctured in at most 4 complex base points of the pencil there exists a projective involution $\sigma_P : L_P \rightarrow L_P$ satisfying the above condition, and thus, a well-defined pencil type dual billiard on the punctured conic γ .

The dual Tabachnikov Conjecture is open. It would imply his above conjecture on integrable projective billiards, and hence, the Birkhoff Conjecture and its versions for billiards on surfaces of constant curvature and for outer planar billiards.

In the previous paper by the author [27] the dual Tabachnikov Conjecture was proved under the additional assumption that the foliation in question admits a non-constant rational first integral. This assumption is equivalent to the existence of a non-constant rational function R whose restriction to each tangent line L_P to γ is invariant under the corresponding involution:

$$(R \circ \sigma_P)|_{L_P} = R|_{L_P}. \tag{1.1}$$

Definition 1.5 [27, definition 1.12] A dual billiard for which there exists a non-constant rational function (called *integral*) satisfying (1.1) is called *rationally integrable*.

Example 1.6 If a dual billiard on a nonlinear curve has a polynomial integral, then it is an outer billiard, that is, the corresponding projective involution of each tangent line is its central symmetry with respect to the tangency point (see [27, example 1.13]). Each pencil type dual billiard is rationally integrable with a quadratic integral (Tabachnikov's observation, see [27, example 1.14]).

It was shown in [27, theorem 1.16] that if a dual billiard is rationally integrable, but the underlying curve γ is not necessarily closed, then

- the curve γ is still a conic;
- the dual billiard structure extends to a global analytic dual billiard structure on the whole conic with at most four points deleted;
- but the dual billiard is not necessary of pencil type.

(Singular) rationally integrable dual billiard structures on conic were classified by [27, theorem 1.16 and its addendum], with explicit formulas for rational integrals. These results are recalled in Subsection 1.2 as Theorem 1.11 and its addendum. The dual version of Theorem 1.11 yields classification of those projective billiards with underlying curve being C^4 -smooth and connected that are *rationally 0-homogeneously integrable*, i.e., whose flow admits a nontrivial first integral that is a rational 0-homogeneous function of the velocity [27, theorem 1.26 and its addendum]. These results are recalled in Subsection 1.3 as Theorem 1.16 and its addendum.

The main result of the present paper is the classification of rationally 0-homogeneously integrable projective billiards *with piecewise C^4 -smooth boundary* that contains a nonlinear arc and maybe also straightline segments (results stated in Subsection 1.5). To classify them, we introduce a generalized dual object to projective billiards with piecewise smooth boundary: the so-called dual multibilliards, which are collections of curves and points equipped with dual billiard structures. We obtain classification of rationally integrable dual multibilliards containing a nonlinear arc (results stated in Subsection 1.4) and then deduce classification of rationally 0-homogeneously integrable projective billiards by using projective duality.

The projective duals to the curvilinear pieces of the boundary of a projective billiard are planar curves equipped with dual billiard structure. The projective dual to each straightline piece of its boundary is a point. The projective billiard structure on the straightline piece (which is an open subset of a projective line) is transformed by duality to *dual billiard structure at a point*, see the next definition.

Definition 1.7 A *dual billiard structure* at a point $Q \in \mathbb{RP}^2(\mathbb{CP}^2)$ is a family of projective involutions $\sigma_{Q,\ell} : \ell \rightarrow \ell$ acting on real (complex) projective lines ℓ through Q . It is assumed that $\sigma_{Q,\ell}$ are defined on an open subset $U \subset \mathbb{RP}^1(\mathbb{CP}^1)$ of the space of lines through Q . No regularity of the family $\sigma_{Q,\ell}$ is assumed.

Definition 1.8 A *real (complex) dual multibilliard* is a (may be infinite) collection of smooth (holomorphic) nonlinear connected curves γ_j and points Q_s in $\mathbb{RP}^2(\mathbb{CP}^2)$ (called *vertices*), where each curve γ_j and each point Q_s are equipped with a dual billiard structure.

Definition 1.9 A dual multibilliard is *rationally integrable*, if there exists a non-constant rational function on $\mathbb{RP}^2(\mathbb{CP}^2)$ whose restriction to each tangent line to every curve γ_j is invariant under the corresponding involution, and the same statement holds for its restriction to each line ℓ through any vertex Q , where the corresponding involution $\sigma_{Q,\ell}$ is defined.

The main results on classification of rationally integrable real and complex dual multibilliards are given by Theorems 1.25, 1.26 and 1.31 in Subsection 1.4. They deal with the case, when the multibilliard is not reduced to one curve (without vertices). In the case, when it contains at least two curves, Theorems 1.25, 1.26 together state that it is rationally integrable, if and only if it is of so-called pencil type. This means that all its curves are conics lying in one pencil and equipped with the dual billiard structure defined by this pencil; its vertices belong to an explicit list of so-called admissible vertices for the given pencil; the collection of vertices of the multibilliard satisfies additional conditions given in Definition 1.23. Theorem 1.26 also yields analogous result in the case, when the multibilliard consists of a single curve equipped with a dual billiard structure of pencil type and maybe some vertices. Theorems 1.25 and 1.11 together imply that every other a priori possible rationally integrable dual multibilliard, not covered by Theorems 1.25, 1.26 is a so-called exotic multibilliard: it is formed by conic equipped with an exotic (i.e., non-pencil) dual billiard structure from Theorem 1.11 and maybe some vertices. Theorem 1.31 yields classification of rationally integrable exotic multibilliards. It implies that such a multibilliard may contain *at most three* vertices, and the dual billiard structure at each vertex is given by a global projective involution fixing the conic.

Recall that a dual multibilliard formed by just a finite collection of conics from the same pencil \mathcal{P} , with dual billiard structures defined by \mathcal{P} , always has a quadratic rational integral, see Example 1.6. If one adds to it appropriate vertex collection (from the finite list of so-called admissible vertices for the pencil \mathcal{P}) so that the dual multibilliard thus obtained be of pencil type, then it will be still rationally integrable, by Theorem 1.26. However, Theorem 1.27 shows that the *minimal degree of its rational integral* may be bigger: *it may be equal to 2, 4 or 12*.

The dual to a pencil type multibilliard defined by a pencil \mathcal{P} is a projective billiard of the so-called dual pencil type. This means that its boundary is piecewise-smooth and consists of arcs of conics from the dual pencil \mathcal{P}^* equipped with projective billiard structures having conical caustics from the same pencil \mathcal{P}^* , and maybe segments of so-called admissible lines for \mathcal{P}^* equipped with appropriate projective billiard structures defined by \mathcal{P}^* . The-

orems 1.38, 1.39 (dual to Theorems 1.25, 1.26) together imply that the dual pencil type projective billiards are rationally 0-homogeneously integrable and the only integrable billiards that are not of pencil type are the so-called exotic ones, with nonlinear part of boundary lying in one conic equipped with an exotic projective billiard structure from Theorem 1.16. The integrable exotic billiards are classified by Theorem 1.45 (dual to Theorem 1.31). Theorem 1.40 (the dual to Theorem 1.27) implies that the *minimal degree of rational 0-homogeneous integral of a dual pencil type projective billiard with piecewise C^4 -smooth boundary may be equal to 2, 4 or 12*. See formulas for integrals of degree 12 in Theorems 1.28, 1.41 and Lemma 1.42.

Remark 1.10 The flow of a Euclidean planar billiard with boundary containing a curvilinear arc admits the trivial first integral: the squared module of the velocity $\|v\|^2 = v_1^2 + v_2^2$. It is known that it admits a non-trivial integral polynomial in the velocity (that is, nonconstant along the unit velocity hypersurface $\{\|v\|^2 = 1\}$), if and only if it is of confocal dual pencil type. This was proved in particular case in [14]; this statement in full generality is a joint result of M.Bialy, A.E.Mironov and the author [8, 25]. Together with results of [14], it implies that *the minimal degree of non-trivial polynomial integral (if it exists) of an Euclidean billiard is equal to either 2, or 4*. A nontrivial polynomial integral $I_x(v)$, which can be chosen of even degree $2n$, generates a non-trivial rational 0-homogeneous integral $\frac{I_x(v)}{\|v\|^n}$. This also implies that *the minimal degree of non-trivial rational 0-homogeneous integral of an Euclidean billiard is also equal to either 2, or 4*. Similar statements hold for billiards on the other surfaces of constant curvature, that is, the round sphere and the hyperbolic plane, and for the projective billiards equivalent to them from Example 1.2. See [14, 8, 9, 25].

Thus, *rationally 0-homogeneously integrable projective billiards of dual pencil type with integrals of degree 12* presented and classified in the present paper *form an essentially new class* of rationally integrable projective billiards of dual pencil type, *not covered by the known list of polynomially integrable billiards* on surfaces of constant curvature.

Plan of proof of main results is presented in Subsection 1.6. A historical survey is given in Subsection 1.7. The main results are proved in Sections 2 (for multibilliards) and 3 (for projective billiards). In Section 4 we prove formulas for degree 12 integrals (Theorems 1.28, 1.41 and Lemma 1.42) and present examples of projective billiards with integrals of degree 4 and 12.

1.2 Previous results 1: classification of real and complex rationally integral dual billiards on one curve

Theorem 1.11 [27, theorem 1.16] *Let $\gamma \subset \mathbb{R}^2 \subset \mathbb{RP}^2$ be a C^4 -smooth connected non-linear (germ of) curve equipped with a rationally integrable dual billiard structure. Then γ is a conic, and the dual billiard structure has one of the three following types (up to real-projective equivalence):*

- 1) *The dual billiard is of conical pencil type and has a quadratic integral.*
- 2) *There exists an affine chart $\mathbb{R}_{z,w}^2 \subset \mathbb{RP}^2$ in which $\gamma = \{w = z^2\}$ and such that for every $P = (z_0, w_0) \in \gamma$ the involution $\sigma_P : L_P \rightarrow L_P$ is given by one of the following formulas:*

a) *In the coordinate*

$$\zeta := \frac{z}{z_0}$$

$$\sigma_P : \zeta \mapsto \eta_\rho(\zeta) := \frac{(\rho - 1)\zeta - (\rho - 2)}{\rho\zeta - (\rho - 1)},$$

$$\rho = 2 - \frac{2}{2N + 1}, \quad \text{or} \quad \rho = 2 - \frac{1}{N + 1} \quad \text{for some } N \in \mathbb{N}. \quad (1.2)$$

b) *In the coordinate*

$$u := z - z_0$$

$$\sigma_P : u \mapsto -\frac{u}{1 + f(z_0)u}, \quad (1.3)$$

$$f = f_{b1}(z) := \frac{5z - 3}{2z(z - 1)} \quad (\text{type } 2b1), \quad \text{or} \quad f = f_{b2}(z) := \frac{3z}{z^2 + 1} \quad (\text{type } 2b2). \quad (1.4)$$

c) *In the above coordinate u the involution σ_P takes the form (1.3) with*

$$f = f_{c1}(z) := \frac{4z^2}{z^3 - 1} \quad (\text{type } 2c1), \quad \text{or} \quad f = f_{c2}(z) := \frac{8z - 4}{3z(z - 1)} \quad (\text{type } 2c2). \quad (1.5)$$

d) *In the above coordinate u the involution σ_P takes the form (1.3) with*

$$f = f_d(z) = \frac{4}{3z} + \frac{1}{z - 1} = \frac{7z - 4}{3z(z - 1)} \quad (\text{type } 2d). \quad (1.6)$$

Addendum to Theorem 1.11. *Every dual billiard structure on γ of type 2a) has a rational first integral $R(z, w)$ of the form*

$$R(z, w) = \frac{(w - z^2)^{2N+1}}{\prod_{j=1}^N (w - c_j z^2)^2}, \quad c_j = -\frac{4j(2N + 1 - j)}{(2N + 1 - 2j)^2}, \quad \text{for } \rho = 2 - \frac{2}{2N + 1}; \quad (1.7)$$

$$R(z, w) = \frac{(w - z^2)^{N+1}}{z \prod_{j=1}^N (w - c_j z^2)}, \quad c_j = -\frac{j(2N + 2 - j)}{(N + 1 - j)^2}, \quad \text{for } \rho = 2 - \frac{1}{N + 1}. \quad (1.8)$$

The dual billiards of types 2b1) and 2b2) have respectively the integrals

$$R_{b1}(z, w) = \frac{(w - z^2)^2}{(w + 3z^2)(z - 1)(z - w)}, \quad (1.9)$$

$$R_{b2}(z, w) = \frac{(w - z^2)^2}{(z^2 + w^2 + w + 1)(z^2 + 1)}. \quad (1.10)$$

The dual billiards of types 2c1), 2c2) have respectively the integrals

$$R_{c1}(z, w) = \frac{(w - z^2)^3}{(1 + w^3 - 2zw)^2}, \quad (1.11)$$

$$R_{c2}(z, w) = \frac{(w - z^2)^3}{(8z^3 - 8z^2w - 8z^2 - w^2 - w + 10zw)^2}. \quad (1.12)$$

The dual billiard of type 2d) has the integral

$$R_d(z, w) = \frac{(w - z^2)^3}{(w + 8z^2)(z - 1)(w + 8z^2 + 4w^2 + 5wz^2 - 14zw - 4z^3)}. \quad (1.13)$$

Theorem 1.12 [27, theorem 1.18 and its addendum]. *Every regular (germ of) connected holomorphic curve in $\mathbb{C}\mathbb{P}^2$ (different from a straight line) equipped with a rationally integrable complex dual billiard structure is a conic. Up to complex-projective equivalence, the corresponding billiard structure has one of the types 1), 2a), 2b1), 2c1), 2d) listed in Theorem 1.11, with a rational integral as in its addendum. The billiards of types 2b1), 2b2), see (1.4), are complex-projectively equivalent, and so are billiards 2c1), 2c2).*

1.3 Previous results 2: classification of rationally 0-homogeneously integrable projective billiards on one curve

Consider a domain $\Omega \subset \mathbb{R}_{x_1, x_2}^2$ with smooth boundary $\partial\Omega$ equipped with a projective billiard structure (transverse line field). The *projective billiard flow*, see [35], acts on $T\mathbb{R}^2|_{\Omega}$. It moves a point $(Q, v) \in T\mathbb{R}^2$, $Q = (x_1, x_2) \in \Omega$, $v = (v_1, v_2) \in T_Q\mathbb{R}^2$ so that v remains constant and Q moves along the straight line directed by v with uniform velocity v , until it hits the boundary $\partial\Omega$ at some point H . Let $v^* \in T_H\mathbb{R}^2$ denote the image of the velocity vector

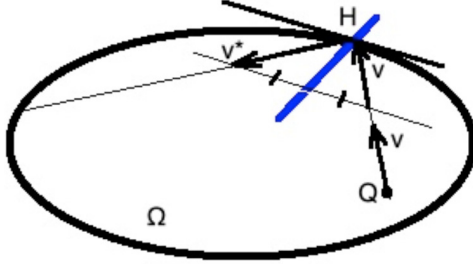

Figure 2: Projective billiard flow

v (translated to H) under the projective billiard reflection from the tangent line $T_H \partial \Omega$. Afterwards it moves (H, v^*) so that H moves with the new uniform velocity v^* until it hits the boundary again etc. See Fig. 2.

Each Euclidean planar billiard flow always has the trivial first integral $\|v\|^2$. But this is not true for a generic projective billiard. It is a well-known folklore fact that Birkhoff integrability of a Euclidean planar billiard with strictly convex closed boundary is equivalent to the existence of a non-trivial first integral of the billiard flow independent with $\|v\|^2$ on a neighborhood of the unit tangent bundle to $\partial \Omega$ in $T\mathbb{R}^2|_{\Omega}$.

Definition 1.13 A projective billiard is *rationally 0-homogeneously integrable*, if its flow admits a first integral that depends on the velocity as a non-constant rational 0-homogeneous function of degree uniformly bounded by some number n : a function $\Psi(Q, v) = \frac{P(v)}{T(v)}$, where P and T are homogeneous polynomials in v of degree no greater than n with coefficients depending on the position of the point Q . The maximal degree of the latter rational function through all Q is called the *degree* of the rational integral.

Example 1.14 The projective billiard structure on (an arc of) a regular conic C is of *dual pencil type*, if it has a regular conical caustic. More precisely, if there exists a conic Γ such that for every point $Q \in C$ the complex tangent lines through Q to the complexified conic Γ are permuted by the projective billiard reflection at Q . Consider now the pencil \mathcal{P} containing the dual conics C^* and Γ^* . Let \mathcal{P}^* denote its dual, consisting of conics dual to the conics from the pencil \mathcal{P} : it contains the conics C and Γ . Then the latter, caustic statement automatically holds for Γ being replaced by any other conic from the dual pencil \mathcal{P}^* . See [27, proposition 1.27, remark 1.28]. A dual pencil type projective billiard on a conic is known to be rationally 0-

homogeneously integrable with a quadratic 0-homogeneous rational integral. This is the statement dual to the similar statement for pencil type dual billiards, see Example 1.6.

Remark 1.15 The notion of rationally 0-homogeneously integrable projective billiard also makes sense for a projective billiard structure on an arc of planar curve C (or a germ of curve), with projective billiard flow defined in a (germ of) domain adjacent to C . A rational 0-homogeneous integral of degree n is always a rational 0-homogeneous function of degree n in three variables: v_1 , v_2 and the moment $\Delta := x_1v_2 - x_2v_1$. See analogous statement for polynomial integrals of the usual planar billiards in [14] and the statement for projective billiards in full generality in [27, proposition 1.23, statement 1)]. The property of rational 0-homogeneous integrability of a projective billiard on a curve C is independent on the side from C on which the billiard domain is chosen: an integral for one side is automatically an integral for the other side. See [27, proposition 1.23, statement 2)].

Theorem 1.16 *Let $C \subset \mathbb{R}_{x_1, x_2}^2$ be a non-linear C^4 -smooth germ of curve equipped with a transversal line field \mathcal{N} . Let the corresponding germ of projective billiard be 0-homogeneously rationally integrable. Then C is a conic; the line field \mathcal{N} extends to a global analytic transversal line field on the whole conic C punctured in at most four points; the corresponding projective billiard has one of the following types up to projective equivalence.*

- 1) *A dual pencil type projective billiard.*
- 2) *$C = \{x_2 = x_1^2\} \subset \mathbb{R}_{x_1, x_2}^2 \subset \mathbb{RP}^2$, and the line field \mathcal{N} is directed by one of the following vector fields at points of the conic C :*

$$2a) \quad (\dot{x}_1, \dot{x}_2) = (\rho, 2(\rho - 2)x_1),$$

$$\rho = 2 - \frac{2}{2N + 1} \text{ (case 2a1), or } \rho = 2 - \frac{1}{N + 1} \text{ (case 2a2), } N \in \mathbb{N},$$

the vector field 2a) has quadratic first integral $\mathcal{Q}_\rho(x_1, x_2) := \rho x_2 - (\rho - 2)x_1^2$.

$$2b1) \quad (\dot{x}_1, \dot{x}_2) = (5x_1 + 3, 2(x_2 - x_1)), \quad 2b2) \quad (\dot{x}_1, \dot{x}_2) = (3x_1, 2x_2 - 4),$$

$$2c1) \quad (\dot{x}_1, \dot{x}_2) = (x_2, x_1x_2 - 1), \quad 2c2) \quad (\dot{x}_1, \dot{x}_2) = (2x_1 + 1, x_2 - x_1).$$

$$2d) \quad (\dot{x}_1, \dot{x}_2) = (7x_1 + 4, 2x_2 - 4x_1).$$

Addendum to Theorem 1.16. *The projective billiards from Theorem 1.16 have the following 0-homogeneous rational integrals:*

Case 1): A ratio of two homogeneous quadratic polynomials in (v_1, v_2, Δ) ,

$$\Delta := x_1v_2 - x_2v_1.$$

Case 2a1), $\rho = 2 - \frac{2}{2N+1}$:

$$\Psi_{2a1}(x_1, x_2, v_1, v_2) := \frac{(4v_1\Delta - v_2^2)^{2N+1}}{v_1^2 \prod_{j=1}^N (4v_1\Delta - c_j v_2^2)^2}. \quad (1.14)$$

Case 2a2), $\rho = 2 - \frac{1}{N+1}$:

$$\Psi_{2a2}(x_1, x_2, v_1, v_2) = \frac{(4v_1\Delta - v_2^2)^{N+1}}{v_1 v_2 \prod_{j=1}^N (4v_1\Delta - c_j v_2^2)}. \quad (1.15)$$

The c_j in (1.14), (1.15) are the same, as in (1.7) and (1.8) respectively.

Case 2b1):

$$\Psi_{2b1}(x_1, x_2, v_1, v_2) = \frac{(4v_1\Delta - v_2^2)^2}{(4v_1\Delta + 3v_2^2)(2v_1 + v_2)(2\Delta + v_2)}. \quad (1.16)$$

Case 2b2):

$$\Psi_{2b2}(x_1, x_2, v_1, v_2) = \frac{(4v_1\Delta - v_2^2)^2}{(v_2^2 + 4\Delta^2 + 4v_1\Delta + 4v_1^2)(v_2^2 + 4v_1^2)}. \quad (1.17)$$

$$\text{Case 2c1):} \quad \Psi_{2c1}(x_1, x_2, v_1, v_2) = \frac{(4v_1\Delta - v_2^2)^3}{(v_1^3 + \Delta^3 + v_1 v_2 \Delta)^2}. \quad (1.18)$$

Case 2c2):

$$\Psi_{2c2}(x_1, x_2, v_1, v_2) = \frac{(4v_1\Delta - v_2^2)^3}{(v_2^3 + 2v_2^2 v_1 + (v_1^2 + 2v_2^2 + 5v_1 v_2)\Delta + v_1 \Delta^2)^2}. \quad (1.19)$$

Case 2d): $\Psi_{2d}(x_1, x_2, v_1, v_2)$

$$= \frac{(4v_1\Delta - v_2^2)^3}{(v_1\Delta + 2v_2^2)(2v_1 + v_2)(8v_1 v_2^2 + 2v_2^3 + (4v_1^2 + 5v_2^2 + 28v_1 v_2)\Delta + 16v_1 \Delta^2)^2}. \quad (1.20)$$

1.4 Main results: classification of rationally integrable planar dual multibilliards with C^4 -smooth curves

Each curve of a rationally integrable dual multibilliard is a conic, being itself an integrable dual billiard, see Theorem 1.11. The first results on classification of rationally integrable dual multibilliards presented below deal with those multibilliards whose curves are conics lying in one pencil, equipped with dual billiard structure defined by the same pencil. They state that its vertices should be admissible for the pencil. To define admissible vertices, let us first introduce the following definition.

Definition 1.17 A *projective angular symmetry* centered at a point $A \in \mathbb{CP}^2$ is a non-trivial projective involution $\sigma_A : \mathbb{CP}^2 \rightarrow \mathbb{CP}^2$ fixing A and each line through A . It is known to have a fixed point line $\Lambda \subset \mathbb{CP}^2$ disjoint from A . Its restrictions to lines through A define a dual billiard structure at A .

Example 1.18 Let now $A \in \mathbb{CP}^2$ and let $\mathcal{S} \subset \mathbb{CP}^2$ be a (may be singular) conic disjoint from A . There exists a projective angular symmetry centered at A and permuting the intersection points with \mathcal{S} of each line through A , called *\mathcal{S} -angular symmetry*, see [25, definition 2.4].

Definition 1.19 Let now $A \in \mathbb{CP}^2$, $\mathcal{S} \subset \mathbb{CP}^2$ be a regular conic through A , and L_A the projective tangent line to \mathcal{S} at A . The *degenerate \mathcal{S} -angular symmetry* centered at A is the involution $\sigma_A = \sigma_A^{\mathcal{S}}$ acting on the complement $\mathbb{CP}^2 \setminus (L_A \setminus \{A\})$ that fixes A , fixes each line $\ell \neq L_A$ through A and whose restriction to ℓ is the projective involution fixing A and the other point of the intersection $\ell \cap \mathcal{S}$. It is known to be a birational map $\mathbb{CP}^2 \rightarrow \mathbb{CP}^2$.

Definition 1.20 A dual billiard structure at a point $A \in \mathbb{CP}^2$ is called *global (quasi-global)* if it is given by a projective angular symmetry (respectively, degenerate \mathcal{S} -angular symmetry) centered at A .

Definition 1.21 Consider a complex pencil of conics in \mathbb{CP}^2 . A vertex, i.e., a point of the ambient plane equipped with a complex dual billiard structure, is called *admissible* for the pencil, if it belongs to the following list of vertices split in two types: *standard*, or *skew*.

Case a): a pencil of conics through 4 distinct points A, B, C, D ; Fig. 3.

a1) The *standard vertices*: $M_1 = AB \cap CD$, $M_2 = AD \cap BC$, $M_3 = AC \cap BD$ equipped with the global dual billiard structure given by the projective angular symmetry $\sigma_{M_j} = \sigma_{M_j}^{M_i M_k}$, $i, k \neq j$, $i \neq k$, centered at M_j with fixed point line $M_i M_k$.

a2) The *skew vertices* K_{EL} , $E, L \in \{A, B, C, D\}$, $E \neq L$: K_{EL} is the intersection point of the line EL with the line $M_i M_j$ such that $M_i, M_j \notin EL$. The involution $\sigma_{K_{EL}}$ is the projective angular symmetry $\mathbb{P}^2 \rightarrow \mathbb{P}^2$ centered at K_{EL} with fixed point line ST , $\{S, T\} = \{A, B, C, D\} \setminus \{E, L\}$.

Case b): a pencil of conics through 3 points A, B, C tangent at the point C to the same line L . See Fig. 4.

b1) One *standard vertex* $M = AB \cap L$, equipped with the projective angular symmetry $\sigma_M : \mathbb{P}^2 \rightarrow \mathbb{P}^2$ centered at M with fixed point line CK_{AB} . The point K_{AB} is defined as follows.

b2) The *skew vertex* $K_{AB} \in AB$ such that the projective involution $AB \rightarrow AB$ fixing M and K_{AB} permutes A and B . That is, the points M ,

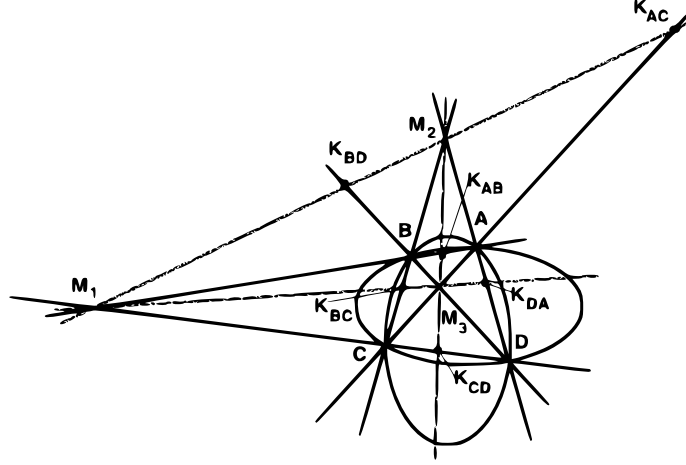

Figure 3:

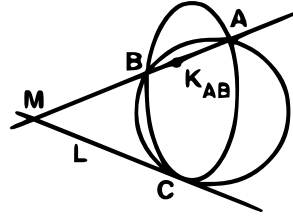

Figure 4:

K_{AB} , A , B form a harmonic quadruple. The dual billiard structure at K_{AB} is given by the projective angular symmetry $\sigma_{K_{AB}} : \mathbb{P}^2 \rightarrow \mathbb{P}^2$ centered at K_{AB} with fixed point line L .

b3) The *skew vertex* C equipped with the projective angular symmetry $\sigma_C = \sigma_C^{AB} : \mathbb{P}^2 \rightarrow \mathbb{P}^2$ centered at C with fixed point line AB .

b4) The *skew vertex* C equipped with a degenerate \mathcal{S} -angular symmetry $\sigma_C = \sigma_C^{\mathcal{S}}$ centered at C , defined by arbitrary given regular conic \mathcal{S} of the pencil; see Definition 1.19. This yields a one-parametric family of quasi-global dual billiard structures at C .

Case c): a pencil of conics through two given points A and C that are tangent at them to two given lines L_A and L_C respectively. See Fig. 20.

c1) *Standard vertices*: $M = L_A \cap L_C$ and any point $M' \in AC$, $M' \neq A, C$. The vertex M is equipped with the projective angular symmetry σ_M centered at M with fixed point line AC . The vertex M' is equipped with the $(L_A \cup L_C)$ -angular symmetry centered at M' , which permutes the intersection points of each line through M' with the lines L_A and L_C .

c2) *Skew vertices equipped with global dual billiard structures*: the points A and C . The dual billiard structure at A (C) is the projective angular

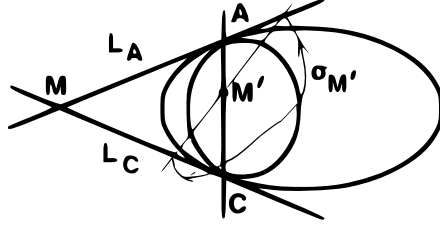

Figure 5:

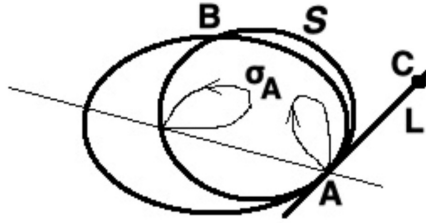

Figure 6:

symmetry centered at A (C) with fixed point line L_C (respectively, L_A).

c3) *Skew vertices* A and C ; A (C) being equipped with a degenerate \mathcal{S}_A (\mathcal{S}_C)-angular symmetry centered at A (C), defined by any regular conic \mathcal{S}_A (\mathcal{S}_C) of the pencil. This yields a one-parametric family of quasi-global dual billiard structures at each one of the vertices A , C , as in b4).

Case d): pencil of conics through two distinct points A and B , tangent to each other at A with contact of order three; let L denote their common tangent line at A . See Fig. 6.

d1) The *skew vertex* A , equipped with a quasi-global dual billiard structure: a degenerate \mathcal{S} -angular symmetry $\sigma_A^{\mathcal{S}}$ centered at A defined by any regular conic \mathcal{S} from the pencil.

d2) Any point $C \in L \setminus \{A\}$, called a *skew vertex*, equipped with a projective angular symmetry σ_C centered at C with fixed point line AB .

Case e): pencil of conics through one given point A , tangent to each other with contact of order four. See Fig. 7. Let L denote their common tangent line at A .

e1) The *skew vertex* A equipped with a degenerate \mathcal{S} -angular symmetry $\sigma_A^{\mathcal{S}}$ centered at A defined by any given regular conic \mathcal{S} of the pencil.

e2) Any point $C \in L \setminus \{A\}$, called a *standard vertex*, equipped with a projective angular symmetry σ_C centered at C . Its fixed point line is the set of those points $D \in \mathbb{P}^2$ for which the line CD is tangent to the conic of the pencil through D at D (including $D = A$).

The definition of real (standard or skew) admissible vertex for a real pencil of conics in \mathbb{RP}^2 is analogous.

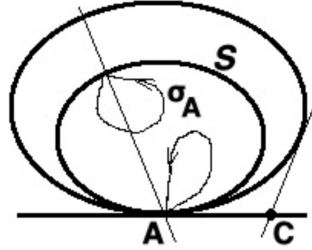

Figure 7:

Definition 1.22 Consider a dual multibilliard formed by some conics and maybe by some vertices. Let the dual billiard structure at each vertex (if any) be either global, or quasi-global, and that on each conic be either of pencil type, or as in Theorem 1.11, Case 2). We say that its two conics (vertices) are *distinct*, if they either are geometrically distinct, or coincide as conics (vertices) but have different dual billiard structures.

Definition 1.23 A (real or complex) dual multibilliard is said to be of *pencil type*, if the following conditions hold.

1) All its curves are conics lying in one pencil, and their dual billiard structures are defined by the same pencil. (Case of one conic equipped with a dual billiard structure of pencil type is possible.)

2) All its vertices are admissible for the pencil.

3) If the multibilliard contains a skew vertex equipped with a quasi-global dual billiard structure, then it contains no other skew vertex, with the following exceptions:

- in Case c) the skew vertex collection is allowed to be the pair of vertices A and C equipped with quasi-global structures defined by one and the same (but arbitrary) regular conic $\mathcal{S} = \mathcal{S}_A = \mathcal{S}_C$ of the pencil.

- in Case d) the skew vertex collection is allowed to be a pair of vertices A and C defined by any given regular conic \mathcal{S} of the pencil: the vertex A is equipped with the quasi-global \mathcal{S} -dual billiard structure; the vertex C is the intersection point of the line L with the line tangent to \mathcal{S} at B , equipped with the projective angular symmetry with fixed point line AB (it coincides with the \mathcal{S} -angular symmetry centered at C).

4) In Case d) the multibilliard may contain at most one vertex $C \in L \setminus \{A\}$.

5) Each skew admissible vertex that a priori admits several possible dual billiard structures listed above is allowed to be included in the multibilliard with no more than one dual billiard structure.

Well-definedness of the above notion of admissible vertex and pencil type dual multibilliard in the real case is implied by the following proposition.

Proposition 1.24 1) Consider a real pencil of conics in \mathbb{RP}^2 whose complexifications pass through four distinct but maybe **complex** points in \mathbb{CP}^2 : pencil of type a). At least one vertex M_j from Definition 1.21 is real, and in this case the involution σ_{M_j} is also real. However in general M_j (K_{EL}) are not necessarily all real.

2) Consider a real pencil of conics whose complexifications form a pencil of type b). All its admissible vertices C , M , K_{AB} are always real, and so are the corresponding global projective involutions. In the case, when C is equipped with a quasi-global structure defined by a real conic, the corresponding involution σ_C is real.

3) For a real pencil with complexification of type c) the admissible vertex M and the corresponding projective involution σ_M are both real. But the vertices A , C , M' are not necessarily real. If M' is real, then so is $\sigma_{M'}$.

4) For a real pencil with complexification of type d) or e) the admissible vertex A is always real. The corresponding involution $\sigma_A = \sigma_{A,S}$ is real, if and only if so is the conic S defining it.

Theorem 1.25 Let a (real or complex) dual multibilliard on a collection of real C^4 -smooth (or holomorphic) nonlinear connected curves γ_j and some vertices be rationally integrable. Then the following statements hold.

1) Each curve γ_j is a conic equipped with a dual billiard structure either of pencil type, or as in Theorem 1.11, Case 2).

2) If the multibilliard contains at least two distinct conics (in the sense of Definition 1.22), then all the conics γ_j lie in the same pencil, and the dual billiard structures on them are defined by the same pencil.

Theorem 1.26 Let in a dual multibilliard all the curves be conics lying in the same pencil. Let them be equipped with the dual billiard structure defined by the same pencil. (Case of one conic equipped with a pencil type dual billiard structure is possible.) Then the multibilliard is rationally integrable, if and only if it is of pencil type, see Definition 1.23.

Theorem 1.27 The minimal degree of a rational integral of a pencil type multibilliard is

(i) degree two, if it contains no skew vertices;

(ii) **degree 12**, if the pencil has type a) and the multibilliard contains some two non-opposite skew vertices, i.e., a pair of vertices of type K_{EL} and K_{ES} for some distinct $E, L, S \in \{A, B, C, D\}$.

(iii) degree four in any other case.

The next theorem yields a formula for integral of degree 12 of pencil type multibilliards for pencils of type a). To state it, let us introduce the following notations. Let $\mathbb{RP}_{[y_1:y_2:y_3]}^2$ denote the ambient projective plane of the multibilliard, considered as the projectivization of the space $\mathbb{R}_{y_1,y_2,y_3}^3$. For every projective line X let $\pi^{-1}(X) \subset \mathbb{R}^3$ denote the corresponding two-dimensional subspace. Let $\xi_X(Y)$ denote a non-zero linear functional vanishing on $\pi^{-1}(X)$. It is well-defined up to constant factor.

Theorem 1.28 *Consider a pencil of conics through four distinct base points A, B, C, D . Set $M_1 = AB \cap CD$, $M_2 = BC \cap AD$, $M_3 = AC \cap BD$.*

1) *The functionals ξ_{EL} corresponding to the lines EL through distinct points $E, L \in \{A, B, C, D\}$ can be normalized by constant factors so that*

$$\xi_{AB}\xi_{CD} + \xi_{BC}\xi_{AD} + \xi_{AD}\xi_{BC} = 0, \quad (1.21)$$

2) *If (1.21) holds, then for every $\mu \in \mathbb{R} \setminus 0$ the degree 12 rational function*

$$\prod_{\{EL;FN\} \neq \{E'L';F'N'\}} \left(\frac{\xi_{EL}\xi_{FN}}{\xi_{E'L'}\xi_{F'N'}}(Y) + \mu \right) \quad (1.22)$$

is a first integral of every pencil type multibilliard defined by the given pencil. Here the product is taken over ordered pairs of two-line sets $\{EL; FN\}$, $\{E'L'; F'N'\}$ with $\{E, L, F, N\} = \{E', L', F', N'\} = \{A, B, C, D\}$. In Theorem 1.27, Case (ii) this is a minimal degree integral.

Definition 1.29 A rationally integrable real (complex) dual billiard structure on conic that is not of pencil type, see Theorem 1.11, Case 2), will be called *exotic*. The singular points of the dual billiard structure (which are exactly the indeterminacy points of the corresponding integral R from the Addendum to Theorem 1.11) will be called the *base points*.

Corollary 1.30 *Let a rationally integrable real (complex) multibilliard be not of pencil type. Then it contains only one curve, namely, a conic equipped with an exotic rationally integrable dual billiard structure from Theorem 1.11, Case 2), and maybe some vertices.*

Theorem 1.31 *A (real or complex) multibilliard consisting of one conic γ equipped with an exotic dual billiard structure from Theorem 1.11, Case 2), and maybe some vertices is rationally integrable, if and only if the collection*

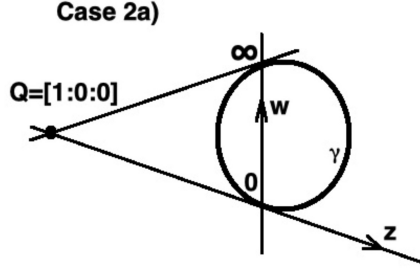

Figure 8: The only admissible vertex in Case 2a) is the infinite point $Q = [1 : 0 : 0]$.

of vertices either is empty, or consists of the so-called **admissible vertices** Q defined below, being equipped with the γ -angular symmetry σ_Q :

(i) Case of type 2a) dual billiard on γ . The **unique admissible vertex** is the intersection point $Q = [1 : 0 : 0]$ of the z -axis and the infinity line; one has $\sigma_Q(z, w) = (-z, w)$ in the chart (z, w) . See Fig. 8. In Subcase 2a1), when $\rho = 2 - \frac{2}{2N+1}$, the function $R(z, w)$ from (1.7) is a rational integral of the multibilliard $(\gamma, (Q, \sigma_Q))$ of minimal degree: $\deg R = 4N + 2$. In Subcase 2a2), when $\rho = 2 - \frac{1}{N+1}$, the function $R^2(z, w)$ with R the same, as in (1.8), is a rational integral of $(\gamma, (Q, \sigma_Q))$ of minimal degree: $\deg R^2 = 4N + 4$.

(ii) Case of type 2b1) or 2b2). There are three base points. One of them, denoted X , is the intersection point of two lines contained in the polar locus $R = \infty$. The **unique admissible vertex** Q is the intersection point of two lines: the tangent line to γ at X and the line through the two other base points. In Case 2b1) one has $Q = (0, -1)$. In Case 2b2) one has $Q = [1 : 0 : 0]$, $\sigma_Q(z, w) = (-z, w)$. The corresponding rational function R , see (1.9), (1.10) is a rational integral of the multibilliard $(\gamma, (Q, \sigma_Q))$ of minimal degree: $\deg R = 4$. See Fig. 9.

(iii) Case of type 2c1) or 2c2). There are three complex base points. There are **three admissible vertices**. Each of them is the intersection point of a line through two base points and the tangent line to γ at the other one. In Case 2c1) the point $(0, -1)$ is the unique real admissible vertex. In Case 2c2) all the admissible vertices are real: they are $(0, -1)$, $(1, 0)$, $[1 : 1 : 0]$, see Fig. 9. The function R is a degree 6 rational integral of the multibilliard formed by the conic γ and arbitrary admissible vertex collection.

(iv) Case of type 2d). No admissible vertices.

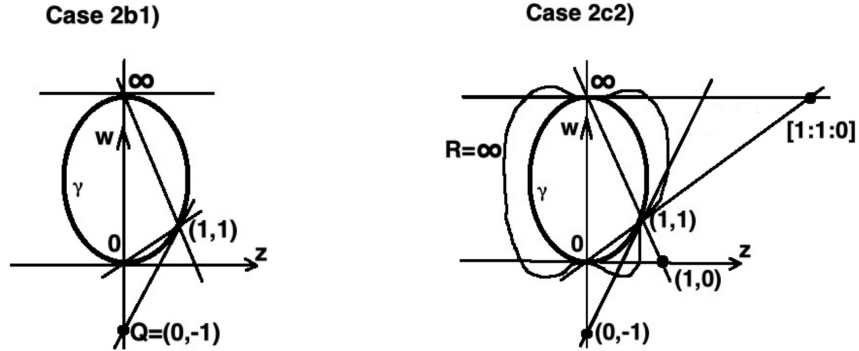

Figure 9: The admissible vertices in Cases 2b1) and 2c2) are marked in bold.

Proposition 1.32 1) The two multibilliards of type (ii) (Cases 2b1), 2b2) with one admissible vertex are complex-projectively equivalent. 2) Two multibilliards of type (iii) (either of different subtypes 2c1), 2c2), or of the same subtype) are complex-projectively equivalent, if and only if they have the same number of vertices. 3) Two real multibilliards of type (iii) are real-projectively equivalent, if and only if they have either both subtype 2c1) and one real admissible vertex, or both subtype 2c2) and the same number (arbitrary, from 1 to 3) of real admissible vertices.

Proposition 1.32 follows from the last statement of Theorem 1.12 and the fact that the dual billiard of type 2c2) has real order three projective symmetry cyclically permuting admissible points.

1.5 Application: classification of rationally 0-homogeneously integrable piecewise C^4 -smooth projective billiards

Let us recall the following definition.

Definition 1.33 The *central* projective billiard structure on a planar curve C with center $O \in \mathbb{R}^2$ is the field of lines on C passing through O .

Everywhere below for two projective lines e and f by ef we will denote their intersection point.

Definition 1.34 Consider a complex dual pencil of conics: a family of conics whose dual form a pencil. Let ℓ be a line equipped with a projective billiard structure; the corresponding line field is well-defined either on all

of ℓ , or on ℓ punctured at one point called singular. The line ℓ is said to be *admissible* for the dual pencil, if it belongs to the following list of lines equipped with projective billiard structures, called either standard, or skew.

Case a): dual pencil of conics tangent to four distinct lines a, b, c, d .

a1) The *standard admissible lines* are the lines m_1, m_2, m_3 through the points ab and cd , the points bc and ad , the points ac and bd respectively. The line m_1 is equipped with projective billiard structure centered at m_2m_3 , and the projective billiard structures on m_2, m_3 are defined analogously.

a2) Let k_{bc} denote the line through the points m_1m_3 and bc , equipped with the projective billiard structure centered at ad : the field of lines through ad . Let k_{ad} be the line through m_1m_3 and ad , equipped with the projective billiard structure centered at bc . The other lines $k_{ef}, e, f \in \{a, b, c, d\}, e \neq f$, equipped with central projective billiard structures are defined analogously. We identify k_{ef} with k_{fe} . All the six lines k_{ef} thus constructed are called *skew admissible lines*. See Fig. 10.

Case b): dual pencil of conics tangent to three distinct lines a, b, c and having common tangency point C with c . See Fig. 11.

b1) The *skew line* c equipped with the field of lines through the point ab .

b2) The *skew line* k such that the quadruple of lines a, b, m, k through the point ab is harmonic. It is equipped with the field of lines through C . Here m is the line through C and ab .

b3) The *standard line* m with the field of lines through the point ck .

b4) For arbitrary given conic \mathcal{S} of the dual pencil the line c equipped with the field of lines tangent to \mathcal{S} is a *skew line*.

Case c): dual pencil of conics tangent to each other at two points A and B . Let a and b denote the corresponding tangent lines. See Fig. 12.

c1) The *standard line* $m = AB$ with the field of lines through ab .

c2) The *skew lines* a and b equipped with the fields of lines through B and A respectively.

c3) Fix arbitrary line $c \neq a, b$ through ab . Let $Z \in m$ denote the point such that the quadruple of points $cm, Z, B, A \in m$ is harmonic. The line c equipped with the field of lines through Z is called a *skew line*.

c4) Fix a regular conic \mathcal{S} from the dual pencil. The lines a and b , each being equipped with the field of lines tangent to \mathcal{S} at points distinct from A and B respectively are called *skew lines*.

Case d): dual pencil of conics tangent to a given line a at a given point A , having triple contact between each other at A , and tangent to another given line $b \neq a$. See Fig. 13.

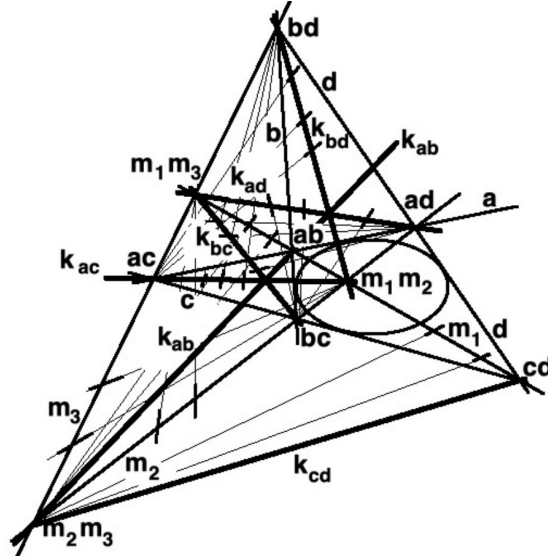

Figure 10: Dual pencil of type a). The standard admissible lines are m_1, m_2, m_3 . The skew admissible lines k_{ef} are marked in bold.

d1) The *skew line* a equipped with the line field tangent to a given (arbitrary) regular conic \mathcal{S} from the pencil.

d2) Any line $c \neq a$ through A called *skew*, equipped with the field of lines through the point ab .

Case e): dual pencil of conics tangent to each other at a point A with order 4 contact. Let a denote their common tangent line at A . See Fig. 14.

e1) The *skew line* a equipped with the line field tangent to a given (arbitrary) regular conic \mathcal{S} from the pencil.

e2) Any line b through A called *skew*, equipped with the field of lines tangent to the conics of the pencil at points of the line b : these tangent lines pass through the same point $C = C(b) \in a$.

Proposition 1.35 *In Case a) for every distinct $e, f, g \in \{a, b, c, d\}$ the lines k_{ef}, k_{fg}, k_{ge} pass through the same point. In particular, the line k_{ab} passes through the intersection points $k_{bd} \cap k_{ad}$ and $k_{ac} \cap k_{bc}$, see Fig. 10.*

Proof The latter intersection points and the point m_2m_3 lie on one line, by the dual Desargues Theorem applied to the triangles $(bd, ad, k_{bd} \cap k_{ad})$ and $(ac, bc, k_{ac} \cap k_{bc})$. The point ab lies on the same line, by Pappus Theorem applied to the triples of points bd, m_1m_3, ac and ad, m_1m_2, bc . \square

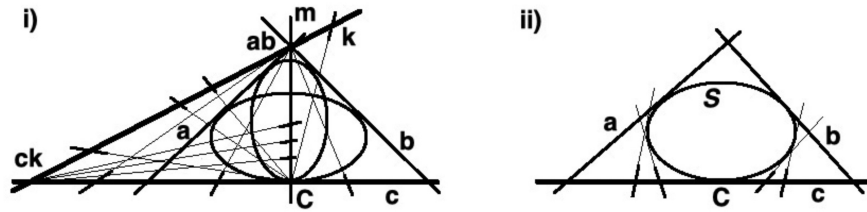

Figure 11: Dual pencil of type b): i) one standard line m and two skew lines c, k ; ii) skew line c with another line field, tangent to a given conic S .

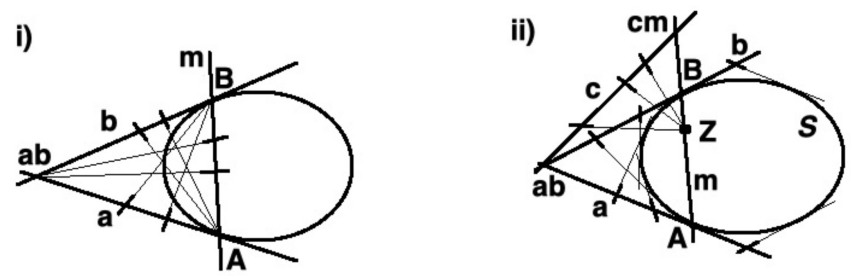

Figure 12: Dual pencil of type c): i) one standard line m and two skew lines a, b equipped with central projective billiard structures; ii) arbitrary line $c \neq a, b$ through ab (called skew) with field of lines through Z , and the skew lines a, b with fields of lines tangent to a given conic S from the pencil.

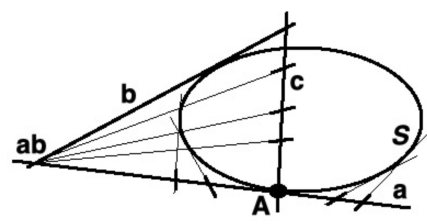

Figure 13: Dual pencil of type d): the skew line a and an arbitrary skew line $c \neq a$.

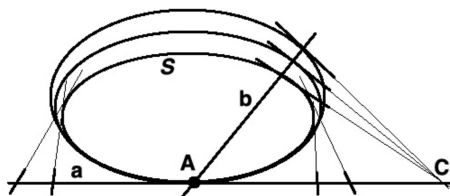

Figure 14: Dual pencil of type e): the skew line a and a standard line $b \neq a$.

Definition 1.36 A projective billiard with *piecewise- C^4 -smooth boundary* having at least one nonlinear smooth arc is said to be of *dual pencil type*, if it satisfies the following conditions:

1) Each C^4 -smooth arc of the boundary is either a conical arc, or a segment. All the conical arcs lie in the same dual pencil and are equipped with the projective billiard structure defined by the same pencil.

2) The segments in the boundary are contained in lines admissible for the pencil and are equipped with the projective billiard structures of the ambient admissible lines.

3) If the boundary contains a skew line segment whose projective billiard structure is not a central one (i.e., given by a field of lines tangent to a conic of the pencil), then the boundary contains no segments of other skew lines with the following exceptions of possible of ambient skew line collections:

- in Case c) the skew line collection is allowed to be the pair of lines a and b equipped with the fields of lines tangent to one and the same (but arbitrary) conic of the pencil;

- in Case d) the skew line collection is allowed to be a pair of lines a and c : a being equipped with the field of lines tangent to a given conic \mathcal{S} from the pencil; c is the line through the point A and the tangency point of the conic \mathcal{S} with the line b , equipped with the field of lines through the point ab .

4) In Case d) the boundary may contain a segment of at most one line $c \neq a$.

5) Each ambient skew line of a boundary segment that a priori admits several possible projective structures listed above is allowed to be included in the boundary with no more than one projective billiard structure.

Remark 1.37 The notion of admissible line for dual pencil is dual to that of admissible vertex of a pencil.

Theorem 1.38 *Let a planar projective billiard with piecewise C^4 -smooth*

boundary containing a nonlinear arc be rationally integrable. Then the following statements hold.

1) All the nonlinear arcs of the boundary are conical. Different arcs of the same conic are equipped with the restriction to them of one and the same projective billiard structure on the ambient conic: either of dual pencil type, or a one from Theorem 1.16, Case 2).

2) If the boundary contains at least two arcs of two distinct regular conics, then all the ambient conics of nonlinear arcs lie in the same dual pencil and their projective billiard structures are defined by the same dual pencil.

Theorem 1.39 *Let a planar projective billiard have piecewise C^4 -smooth boundary whose all nonlinear C^4 -smooth pieces are conical arcs lying in the same dual pencil and equipped with projective billiard structures defined by the same pencil. Then the billiard is 0-homogeneously rationally integrable, if and only if it is of dual pencil type.*

Theorem 1.40 *The minimal degree of 0-homogeneous rational integral of a dual pencil type projective billiard is*

- (i) degree two, if its boundary contains no skew line segment;
- (ii) **degree 12**, if the dual pencil has type a) and the billiard boundary contains segments of some two skew admissible lines k_{ef}, k_{fs} for some distinct $e, f, s \in \{a, b, s, d\}$;
- (iii) degree four in any other case.

Theorem 1.41 *Consider a type a) dual pencil of conics tangent to given four distinct lines a, b, c, d . Let us consider the ambient plane \mathbb{R}_{x_1, x_2}^2 as the horizontal plane $\{x_3 = 1\} \subset \mathbb{R}_{x_1, x_2, x_3}^3$. Set*

$$r := (x_1, x_2, 1) \in \mathbb{R}^3, \quad v = (v_1, v_2, 0) \text{ for every } (v_1, v_2) \in T_{(x_1, x_2)}\mathbb{R}^2,$$

$$\mathcal{M} = \mathcal{M}(r, v) := [r, v] = (-v_2, v_1, \Delta), \quad \Delta := x_1 v_2 - x_2 v_1. \quad (1.23)$$

In the above notations for intersection points em of lines e and m set

$$r(em) = (x_1(em), x_2(em), 1).$$

There exists a collection of three numbers $\chi_{em;fn} \in \mathbb{R}$, $\{e, m, f, n\} = \{a, b, c, d\}$, indexed by unordered pairs of intersection points $em = e \cap m$, $fn = f \cap n$ ($(em; fn) = (fn; em)$, by definition) such that

$$\sum_{(em;fn)} \chi_{em;fn} \langle r(em), \mathcal{M} \rangle \langle r(fn), \mathcal{M} \rangle = 0 \quad (1.24)$$

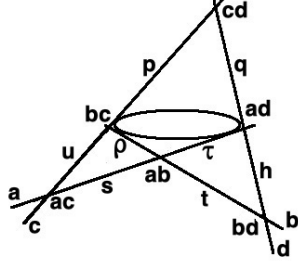

Figure 15: Pencil of type a). Distances between intersection points.

as a quadratic form in \mathcal{M} . This collection is unique up to common constant factor. For every $\mu \in \mathbb{R} \setminus \{0\}$ the corresponding expression

$$\prod_{(em;fn) \neq (e'm';f'n')} \left(\frac{\chi_{em;fn} \langle r(em), \mathcal{M} \rangle \langle r(fn), \mathcal{M} \rangle}{\chi_{e'm';f'n'} \langle r(e'm'), \mathcal{M} \rangle \langle r(f'n'), \mathcal{M} \rangle} + \mu \right) \quad (1.25)$$

is a degree 12 first integral of every projective billiard of dual pencil type defined by the pencil in question. Here the product is taken over ordered "big" pairs: any two indices $((em;fn);(e'm';f'n'))$ and $((e'm';f'n');(em;fn))$ that differ by permutation correspond to two distinct factors in the product.

Lemma 1.42 Consider the following segment lengths, see Fig. 15:

$$\rho := |bc - ab|, \quad t := |ab - bd|, \quad \tau := |ad - ab|, \quad s := |ab - ac|. \quad (1.26)$$

Here the lengths are oriented: lengths of two adjacent aligned segments (say, s and τ), are taken with the same sign, if their common end separates them (ab lies between the points ac and ad), and with opposite signs otherwise. Relation (1.24) (and hence, the statements of Theorem 1.41) hold for

$$(\chi_{ab;cd}, \chi_{bc;ad}, \chi_{ac;bd}) = \left(\frac{st}{\rho\tau} - 1, -\frac{st}{\rho\tau}, 1 \right). \quad (1.27)$$

Definition 1.43 A rationally 0-homogeneously integrable projective billiard structure on a conic γ that is not of dual pencil type (i.e., any projective billiard structure from Theorem 1.16, Case 2)) will be called *exotic*. Its singular points (which are the points, where the corresponding line field is either undefined, or tangent to γ) will be called the *base points*.

Corollary 1.44 *Let a rationally integrable projective billiard with piecewise C^4 -smooth boundary be not of dual pencil type. Let its boundary contain at least one nonlinear arc. Then all its nonlinear arcs lie in one conic, equipped with an exotic projective billiard structure from Theorem 1.16, Case 2).*

Theorem 1.45 *Let a projective billiard has piecewise smooth boundary consisting of arcs of one and the same conic γ equipped with an exotic projective billiard structure from Theorem 1.16, Case 2), and maybe some straightline segments. The billiard is rationally integrable, if and only if the collection of ambient lines of the boundary segments either is empty, or consists of the following **admissible lines** equipped with central-projective billiard structures:*

(i) *Case of type 2a) projective billiard structure on γ ; $\rho = 2 - \frac{2}{m}$, $m \in \mathbb{N}$, $m \geq 3$. The unique admissible line is the vertical x_2 -axis, equipped with the normal (i.e., horizontal) line field. See Fig. 16. The projective billiard bounded by a half of γ and the x_2 -axis has a rational 0-homogeneous integral of minimal degree $2m$: the function Ψ_{2a1} from (1.14) for odd m ; the function Ψ_{2a2}^2 with Ψ_{2a2} the same, as in (1.15), for even m . See Fig. 16.*

(ii) *Case of type 2b1). The unique admissible line is the line $\{x_2 = 1\}$ equipped with the field of lines through the point $(0, -1)$.*

(iii) *Case of type 2b2). The unique admissible line is the Ox_2 -axis equipped with the normal (horizontal) line field. See Fig. 17. In both cases 2b1), 2b2) the functions Ψ_{2b1} , Ψ_{2b2} from (1.16) and (1.17) are integrals of minimal degree 4 for each billiard bounded by γ and the admissible line.*

(iv) *Case of type 2c1). The unique admissible line is the line $\{x_2 = 1\}$ equipped with the field of lines through the point $(0, -1)$.*

(v) *Case of type 2c2). There are three admissible lines:*

- *the line $\{x_2 = 1\}$, with the field of lines through the point $(0, -1)$;*
- *the line $\{x_1 = -\frac{1}{2}\}$, with the line field parallel to the vector $(-1, 1)$;*
- *the line $\{x_2 = -2x_1\}$, with the field of lines through the point $(-1, 0)$.*

See Fig. 18. In both cases 2c1), 2c2) the corresponding functions Ψ_{2c1} , Ψ_{2c2} from (1.18) and (1.19) are integrals of minimal degree 6 for each billiard bounded by γ and segments of admissible lines.

(vi) *Case of type 2d). No admissible lines.*

1.6 Plan of proofs of main results

Step 1. In Subsection 2.1 we prove rational integrability of pencil type complex multibilliard. (This implies analogous result in the real case.) To do this, we show that for every pencil all the involutions associated

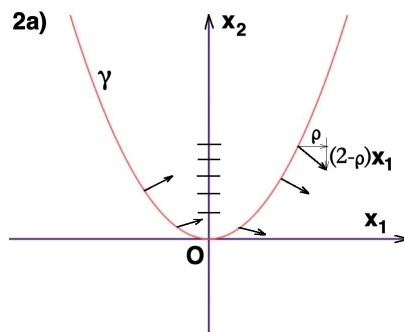

Figure 16: The only admissible line in Case 2a) is the Ox_2 -axis.

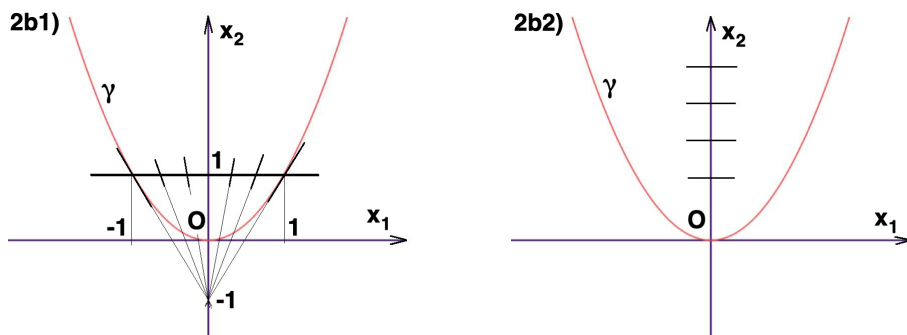

Figure 17: The only admissible line in Case 2b1) is the line $\{x_2 = 1\}$. The only admissible line in Case 2b2) is the x_2 -axis.

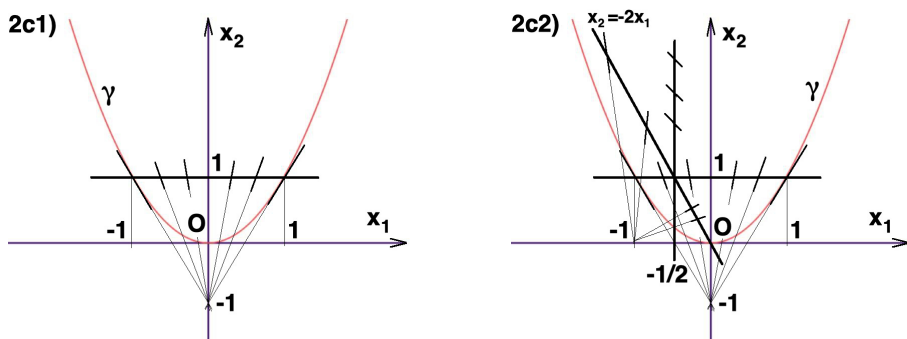

Figure 18: The only admissible line in Case 2c1) is the line $\{x_2 = 1\}$. In Case 2c2) there are three admissible lines: $\{x_2 = 1\}$; $\{x_1 = -\frac{1}{2}\}$, $\{x_2 = -2x_1\}$.

to all the corresponding admissible vertices preserve the pencil and act on its parameter space $\overline{\mathbb{C}}$ by conformal involutions (Proposition 2.1). We fix an arbitrary collection of admissible vertices and consider the subgroup $G \subset \text{Aut}(\overline{\mathbb{C}}) = \text{PSL}_2(\mathbb{C})$ generated by the corresponding conformal involutions. We show that finiteness of the group G is equivalent to the system of Conditions 3)–5) of Definition 1.23 of pencil type multibilliard (Proposition 2.4), and in this case G is either trivial, or isomorphic to either \mathbb{Z}_2 , or S_3 . We then deduce rational integrability of every pencil type multibilliard with integral of degree $2|G| \in \{2, 4, 12\}$.

To classify rationally integrable dual multibilliards, in what follows we consider an arbitrary dual multibilliard with a rational integral Ψ . Each its curve is already known to be a conic equipped with either a pencil type dual billiard structure, or an exotic billiard structure from Theorem 1.11, Case 2). We fix some its conic \mathcal{S} and consider the canonical integral R of its dual billiard structure: either a quadratic integral in the case of pencil; of the corresponding integral from the Addendum to Theorem 1.11.

Step 2. In Subsection 2.2 we show that the singular foliations $\Psi = \text{const}$ and $R = \text{const}$ on \mathbb{CP}^2 coincide. We show that a generic level curve of the integral R is irreducible, of the same degree $d = \deg R$, and thus, R is a rational first integral of minimal degree for the above foliation. In the exotic case we also show that the conic \mathcal{S} is its unique level curve of multiplicity d , which means that the irreducible level curves of the function R accumulating to \mathcal{S} converge to $\frac{d}{2}[\mathcal{S}]$ as divisors: the intersection of a small cross-section to \mathcal{S} with a level curve close to \mathcal{S} consists of $\frac{d}{2}$ points.

Step 3. We then deduce (in Subsection 2.2) that if on some conic of the multibilliard the dual billiard structure is defined by a pencil (or if the multibilliard contains at least two distinct conics), then the above foliation coincides with the pencil and the dual billiard structures on all the other conics are defined by the same pencil. This will prove Theorem 1.25. Results of Step 1 together with constance of integral on the conics of the pencil (given by Step 2) imply Theorem 1.27.

Step 4. In Subsection 2.3 we study vertices of the multibilliard. First we show that the family of involutions $\sigma_{A,\ell} : \ell \rightarrow \ell$ associated to each vertex A is given by the restrictions to the lines ℓ through A of a birational involution $\sigma_A : \mathbb{CP}^2 \rightarrow \mathbb{CP}^2$ preserving the foliation $\Psi = \text{const}$. Then we deduce that each σ_A is either a projective angular symmetry, or a degenerate angular symmetry defined by a regular conic \mathcal{S} through A . We show that in the latter case the foliation $\Psi = \text{const}$ is a pencil of conics containing \mathcal{S} .

Step 5. In Subsection 2.4 we prove Theorem 1.26. It deals with the case,

when the foliation $\Psi = \text{const}$ is a pencil of conics. We show that each vertex of the multibilliard is admissible. Each level curve of the function Ψ is a collection of at most $\frac{\deg \Psi}{2}$ conics of the pencil, and it is invariant under the involutions defining the dual billiard structures at the vertices. This implies finiteness of the group G generated by the conformal involutions corresponding to the vertices. Together with the results of Step 1 (Subsection 2.1), this implies that the multibilliard is of pencil type.

In Subsection 2.5 we prove Theorem 1.31 on classification of rationally integrable multibilliards consisting of a conic \mathcal{S} with an exotic dual billiard structure and (may be) some vertices. We describe the corresponding admissible vertices using the result of Step 4 stating that the corresponding involutions are projective angular symmetries.

In Subsection 2.6 we prove Proposition 1.24.

In Section 3 we prove the main results on classification of rationally 0-homogeneously integrable projective billiards with C^4 -smooth boundaries (Theorems 1.38, 1.39, 1.40, 1.45). We reduce them to the main results on dual multibilliards. Namely, we consider the projective duality given by orthogonal polarity, which transforms a projective billiard to a dual multibilliard. We consider the ambient plane $\mathbb{R}^2_{x_1, x_2}$ of the projective billiard as the horizontal plane $\{x_3 = 1\} \subset \mathbb{R}^3_{x_1, x_2, x_3}$, set $r = (x_1, x_2, x_3)$. We use the fact that a rational 0-homogeneous integral of a projective billiard can be written as a rational 0-homogeneous function $R(\mathcal{M})$ of the moment vector $\mathcal{M} = [r, v]$, where v is the velocity, and $R(\mathcal{M})$ is a rational integral of the corresponding dual multibilliard in $\mathbb{RP}^2_{[\mathcal{M}_1: \mathcal{M}_2: \mathcal{M}_3]}$. We show that this yields a bijective correspondence between rational 0-homogeneous integrals of the projective billiard and rational integrals of the corresponding dual multibilliard. This together with the results from [27] on duality between exotic dual billiards from Theorem 1.11 and exotic projective billiards from Theorem 1.16 and the results of the present paper on dual multibilliards will imply the main results on projective billiards.

1.7 Historical remarks

Existence of a continuum of closed caustics in every strictly convex bounded planar billiard with sufficiently smooth boundary was proved by V.F.Lazutkin [31]. Existence of continuum of foliations by (non-closed) caustics in open billiards was proved by the author [26]. H.Poritsky [33] (and later E.Amiran [2]) proved the Birkhoff Conjecture under the additional assumption that for every two caustics the smaller one is a caustic for the bigger one. M.Bialy [3] proved that if the phase cylinder is foliated by non-contractible invariant

curves for the billiard map, then the billiard table is a disk. See also [42], where another proof of Bialy's result was given, and Bialy's papers [4, 5] for similar results on billiards on constant curvature surfaces and on magnetic billiards on these surfaces. D.V.Treschev conjectured existence of billiards where the squared billiard map has fixed point where its germ is analytically conjugated to rotation and confirmed this by numerical experiments: in two dimensions [37, 38] and in higher dimensions [39]. V.Kaloshin and A.Sorrentino [28] proved that *any integrable deformation of an ellipse is an ellipse*. For ellipses with small excentricities this result was earlier proved by A.Avila, V.Kaloshin and J. De Simoi [1]. Recently M.Bialy and A.B.Mironov proved the Birkhoff Conjecture for centrally-symmetric billiards admitting a continuous family of caustics extending up to a caustic of 4-periodic orbits [12]. For a dynamical entropic version of the Birkhoff Conjecture and related results see [32]. For a survey on the Birkhoff Conjecture and results see [28, 29, 12] and references therein.

A.P.Veselov proved a series of complete integrability results for billiards bounded by confocal quadrics in space forms of any dimension and described billiard orbits there in terms of a shift of the Jacobi variety corresponding to an appropriate hyperelliptic curve [40, 41]. Dynamics in (not necessarily convex) billiards of this type was also studied in [15, 16, 17, 18, 19].

The Polynomial Birkhoff Conjecture together with its generalization to piecewise smooth billiards on surfaces of constant curvature was stated by S.V.Bolotin and partially studied by himself, see [13], [14, section 4], and by M.Bialy and A.E.Mironov [6]. Its complete solution is a joint result of M.Bialy, A.E.Mironov and the author given in the series of papers [8, 9, 24, 25]. It implies that if a polynomial integral of a piecewise smooth billiard exists, then its minimal degree is equal to either two, or four. For a survey of Bolotin's Polynomial Birkhoff Conjecture and of its version for magnetic billiards (an open conjecture, with a substantial progress made in [7, 10]) and related results see [30, 29, 8, 9, 7, 10, 11] and references therein.

The generalization of the Birkhoff Conjecture to dual billiards was stated by S.Tabachnikov in [36]. Its rationally integrable version was solved by the author of the present paper in [27]. Its polynomially integrable version for outer billiards was stated and partially studied in [36] and solved completely in [23]. Projective billiards were introduced by S.Tabachnikov [35]. He had shown in the same paper that if a projective billiard on circle has an invariant area form smooth up to the boundary of the phase cylinder, then it is integrable.

A series of results on the analogue of Ivrii Conjecture on periodic orbits in billiard (stating that their Lebesgue measure is zero) for projective billiards

was obtained by C.Fierobe [20, 21, ?].

2 Rationally integrable dual multibilliards. Proofs of Theorems 1.25, 1.26, 1.31, 1.27

2.1 Rational integrability of pencil type multibilliards

Proposition 2.1 *Consider a complex pencil of conics and the corresponding admissible vertices. For every standard vertex the corresponding involution leaves invariant each conic of the pencil. For every skew vertex the corresponding involution permutes conics of the pencil non-trivially: it acts as a conformal involution of the parameter space $\overline{\mathbb{C}}$ of the complex pencil.*

Proof Case a): pencil of conics through four distinct basic points A, B, C, D , see Fig. 3. It is well-known that in this case no three of them lie on the same line. This implies that the three vertices M_j are well-defined, distinct, do not lie on the same line and different from the basic points, and so are the vertices K_{EL} , and the latter are distinct from the vertices M_j . Set

$$\Gamma_1 := AB \cup CD, \Gamma_2 := BC \cup AD, \Gamma_3 = AC \cup BD. \quad (2.1)$$

Let $\sigma_{M_1} : \mathbb{CP}^2 \rightarrow \mathbb{CP}^2$ be the Γ_2 -angular symmetry centered at M_1 : the projective involution fixing each line through ℓ and permuting its intersection points with the lines AD and BC . It permutes the points A and B, C and D . Hence, it preserves the pencil. It fixes the line M_2M_3 , which passes through the points $AD \cap BC$ and $AC \cap BD$. Hence, it fixes each its point X , since it fixes the line M_1X . The pencil is parametrized by a parameter $\lambda \in \overline{\mathbb{C}}$, and σ_{M_1} acts on $\overline{\mathbb{C}}_\lambda$ by conformal automorphism. Let $\lambda_1, \lambda_2, \lambda_3 \in \overline{\mathbb{C}}$ denote the parameter values corresponding to the singular conics $\Gamma_1, \Gamma_2, \Gamma_3$ respectively. Each Γ_j is σ_{M_1} -invariant, by construction. Therefore, the conformal automorphism $\overline{\mathbb{C}} \rightarrow \overline{\mathbb{C}}$ induced by σ_{M_1} fixes three distinct points $\lambda_1, \lambda_2, \lambda_3$. Hence, it is identity, and σ_{M_1} preserves each conic of the pencil. This proof is valid for the other vertices M_j .

The involution $\sigma_{K_{BC}}$ is the projective angular symmetry centered at K_{BC} with fixed point line AD . Hence, it fixes M_2 .

Claim 1. *The involution $\sigma_{K_{BC}}$ permutes B and C . Or equivalently, the quadruple of points K_{BC}, M_2, B, C on the line BC is harmonic.*

Proof The restriction of the involution $\sigma_{K_{BC}}$ to the line BC coincides with the involution σ_{M_2} , since both of them are non-trivial projective involutions of the line BC fixing K_{BC} and M_2 . The involution σ_{M_2} permutes B and C , as in the above discussion on σ_{M_1} . Hence, so does $\sigma_{K_{BC}}$. \square

Corollary 2.2 *Each one of the involutions $\sigma_{K_{BC}}$, σ_{AD} fixes Γ_2 and permutes Γ_1, Γ_3 . Hence, it yields a non-trivial conformal involution $\overline{\mathbb{C}}_\lambda \rightarrow \overline{\mathbb{C}}_\lambda$ of the parameter space of the pencil, fixing λ_2 and permuting λ_1, λ_3 .*

Proof The involution $\sigma_{K_{BC}}$ fixes A, D and permutes B, C . Similarly, the involution $\sigma_{K_{AD}}$ fixes B, C and permutes A, D . \square

Case b): pencil of conics through three distinct points A, B, C tangent at the point C to the same line L , see Fig. 4. The involution σ_M fixes the points C, K_{AB} , the line L and permutes A and B , by definition and harmonicity of the quadruple M, K_{AB}, A, B . Therefore, it preserves the pencil. Similarly, the involution $\sigma_{K_{AB}}$ preserves the pencil. And so does the involution $\sigma_C : \mathbb{CP}^2 \rightarrow \mathbb{CP}^2$ defined to fix C and each point of the line AB . Now the pencil, parametrized by a parameter $\lambda \in \overline{\mathbb{C}}$, contains just two singular conics:

$$\Gamma_1 := AB \cup L, \Gamma_2 := AC \cup BC, \quad (2.2)$$

corresponding to some parameter values λ_1 and λ_2 .

Claim 2. *The involution σ_M and the composition $\sigma_C \circ \sigma_{K_{AB}}$ preserve each conic of the pencil. Each one of the involutions $\sigma_C, \sigma_{K_{AB}}$ fixes only the conics Γ_1, Γ_2 of the pencil.*

Proof The pencil in question is the limit of a family of pencils of conics through A, B, C_μ, D_μ with basic points C_μ, D_μ depending on small parameter μ , confluenting to C , as $\mu \rightarrow 0$, so that the line $C_\mu D_\mu$ pass through $M = M_1$ and tends to the tangent line L , as $\mu \rightarrow 0$. Then $M_2 = M_2(\mu) \rightarrow C$, $M_3 = M_3(\mu) \rightarrow C$, and the involutions $\sigma_{M_1} = \sigma_{M_1(\mu)}$ corresponding to the perturbed pencil, with $\mu \neq 0$, converge to σ_M , as $\mu \rightarrow 0$. The involution $\sigma_{M_1(\mu)}$ preserves each conic of the pencil for $\mu \neq 0$. Hence, so does its limit σ_M . The involutions at the vertices $K_{C_\mu D_\mu}, K_{AB}$ converge to σ_C and $\sigma_{K_{AB}}$, by construction. They act on the perturbed pencil as non-trivial involutions, permuting conics in the same way (Corollary 2.2). Hence, this statement remains valid for their limits σ_C and $\sigma_{K_{AB}}$. The claim is proved. \square

Proposition 2.3 *Consider a pencil of complex conics that are tangent to each other at a point C . Let \mathcal{S} be its regular conic, and let C be equipped with the quasi-global dual billiard structure defined by \mathcal{S} . Then the corresponding involution σ_C preserves the pencil and induces a nontrivial conformal involution $\overline{\mathbb{C}} \rightarrow \overline{\mathbb{C}}$ of its parameter space.*

Proof Let L denote the common projective tangent line at C to the regular conics of the pencil. Let us take an affine chart $\mathbb{C}_{z,w} = \mathbb{CP}^2 \setminus L$ so that C is

the intersection point of the w -axis with the infinity line L . Then the conics of the pencil are parabolas $\mathcal{S}_\lambda := \{w = (a_1z^2 + b_1z + c_1) + \lambda(a_2z^2 + b_2z + c_2)\}$. Let us normalize the parameter λ so that $\mathcal{S}_0 = \mathcal{S}$. Then in the affine chart (z, w) one has

$$\sigma_C(z, w) = (z, 2(a_1z^2 + b_1z + c_1) - w).$$

Hence, $\sigma_C(\mathcal{S}_\lambda) = \mathcal{S}_{-\lambda}$. The proposition is proved. \square

Case c): pencil of conics through two distinct points A and C tangent to two given lines L_A and L_C through them; $L_A, L_C \neq AC$. See Fig. 5. Fix an arbitrary point $M' \in AC \setminus \{A, C\}$.

Claim 3. *The projective angular symmetries σ_A, σ_C with fixed point lines L_C and L_A respectively preserve the pencil. The involutions $\sigma_M, \sigma_{M'}$ and the composition $\sigma_A \circ \sigma_C$ preserve each conic of the pencil.*

The claim is proved analogously to the above discussion, by considering the pencil in question as the limit of the family of pencils through points $A_\mu, B_\mu, C_\mu, D_\mu, A_\mu, B_\mu \rightarrow A, C_\mu, D_\mu \rightarrow C$, as $\mu \rightarrow 0$ so that $A_\mu B_\mu = L_A, C_\mu D_\mu = L_C$, and the lines $A_\mu C_\mu, B_\mu D_\mu$ are intersected at M' . Similarly to the above discussion, the involutions corresponding to $K_{A_\mu B_\mu}$ and $K_{C_\mu D_\mu}$ converge to σ_A and σ_C respectively. This implies the statement of the claim on the involutions $\sigma_M, \sigma_A, \sigma_C$. It remains to prove its statement on the vertex M' . The intersection point $M_2(\mu)$ of the lines $B_\mu C_\mu$ and $A_\mu D_\mu$, the point M' , and the intersection points of the line $M_2(\mu)M'$ with lines L_A, L_C form a harmonic tuple of points on the line $M_2(\mu)M'$, as in Claim 1. Hence, the involution $\sigma_{M', \mu}$ corresponding to the vertex M' and the perturbed pencil, with $\mu \neq 0$, fixes M' and each line through M' and permutes its intersection points with the lines L_A and L_C . Thus, it coincides with the involution $\sigma_{M'}$ corresponding to the nonperturbed pencil. Hence, $\sigma_{M'}$ preserves each conic of the nonperturbed pencil, as of the perturbed one.

Consider the skew vertices in Cases c), d), e) equipped with quasi-global dual billiard structures. The corresponding involutions preserve the pencil and induce nontrivial conformal involutions of $\overline{\mathbb{C}}_\lambda$, by Proposition 2.3.

Consider now the vertices C in Cases d) and e). In Case d) the involution σ_C preserves the singular conic $L \cup AB$ of the pencil and the conic tangent to BC at B , as σ_M in Claim 3. Hence, it preserves the pencil. It does not preserve other conics, since their tangent lines at B are not σ_C -invariant. In Case e) σ_C preserves each conic of the pencil. This can be seen in the affine chart (z, w) for which C, A are the intersection point of the infinity line with the z - and w -axes respectively, and the conics are the parabolas $w = z^2 + \lambda$: $\sigma_C(z, w) = \sigma_C(-z, w)$. Proposition 2.1 is proved. \square

Proposition 2.4 *Let in a complex dual multibilliard all the curves be conics lying in a pencil, and their dual billiard structures be defined by the same pencil. Let all its vertices be admissible for the pencil. Let $G \subset PSL_2(\mathbb{C}) = Aut(\overline{\mathbb{C}})$ denote the group generated by conformal transformations of the parameter space $\overline{\mathbb{C}}$ of the pencil induced by the involutions associated to the vertices, see Proposition 2.1. Then the following statements are equivalent:*

(i) *The group G is finite.*

(ii) *The vertex collection satisfies Conditions 3)–5) of Definition 1.23.*

If the group G is finite, then it is either trivial (if and only if the multibilliard contains no skew vertex), or isomorphic to \mathbb{Z}_2 or S_3 . One has $G = S_3$, if and only if the pencil has type a) and the multibilliard contains some two skew vertices K_{EX} , K_{EY} with base point pairs having one common point.

Proof Let us first prove equivalence of statements (i) and (ii).

Case of pencil of type a). Then Conditions 3)–5) of Definition 1.21 impose no restriction on admissible vertex collection. The involution defining the dual billiard structure at each admissible vertex preserves the triple of the singular conics $\Gamma_1, \Gamma_2, \Gamma_3$ of the pencil, see (2.1). Therefore, the conformal involutions $\overline{\mathbb{C}} \rightarrow \overline{\mathbb{C}}$ of the parameter space defined by the skew vertices permute the corresponding parameter values $\lambda_1, \lambda_2, \lambda_3$, and hence, generate a finite group $G \subset PSL_2(\mathbb{C})$ isomorphic to a subgroup of S_3 . The conformal involution corresponding to a standard vertex is trivial. Each one of the involutions $\sigma_{K_{BC}}, \sigma_{AD}$ fixes the singular conic Γ_2 and permutes Γ_1, Γ_3 (Corollary 2.2). See the above proof of Proposition 2.1. These two statements and the versions of the latter statement for the other base points together imply the statements of Proposition 2.4.

Case of pencil of type b). For every skew vertex equipped with a projective angular symmetry the latter symmetry fixes only the parameter values λ_1, λ_2 corresponding to the singular conics Γ_1, Γ_2 from (2.2), see Claim 2 in the proof of Proposition 2.1.

Suppose the multibilliard contains only vertices of the above type. Then the group G is either trivial (if the skew vertex subset is empty), or isomorphic to \mathbb{Z}_2 (if it is non-empty), by the above statement.

Let now the multibilliard contain the skew vertex C equipped with a degenerate \mathcal{S} -angular symmetry defined by a regular conic \mathcal{S} of the pencil. Let $\lambda_{\mathcal{S}}$ denote the parameter value corresponding to \mathcal{S} . The conformal involution corresponding to the vertex C fixes only λ_2 and $\lambda_{\mathcal{S}}$. Therefore, if the multibilliard contains no other skew vertices, then $G \simeq \mathbb{Z}_2$. If it contains another skew vertex, then G is generated by two involutions having only one common fixed point λ_2 . Their composition is a parabolic transformation

with the unique fixed point λ_2 . It has infinite order. Hence, G is infinite.

Case of pencil of type c) is treated analogously.

Case of pencil of type d). The involution σ_C corresponding to a skew vertex $C \in L \setminus \{A\}$ is a projective angular symmetry fixing two conics: the singular conic $L \cup AB$ and the regular conic \mathcal{S} of the pencil that is tangent to the line CB at B . The correspondence $\mathcal{S} \mapsto C$ is bijective. This implies that G is finite, if and only if the involution corresponding to any other skew vertex of the multibilliard fixes the same conic \mathcal{S} , as in the above discussion. This holds, if and only if Conditions 3)–5) of Definition 1.21 hold.

Case of pencil of type e) is treated analogously, with the singular conic now being the double line L . Proposition 2.4 is proved. \square

Proposition 2.5 *Every multibilliard of pencil type is rationally integrable, with integral of minimal degree $2|G| \in \{2, 4, 12\}$, where $|G|$ is the cardinality of the group G .*

Proof The group G is finite, by Proposition 2.4 and since the multibilliard is of pencil type (hence, satisfying Conditions 3)–5) of Definition 1.21). Let F be a quadratic first integral of the pencil: the ratio of two quadratic polynomials defining two its conics. Its constant value on each conic coincides with the corresponding parameter λ (after replacing F by its post-composition with conformal automorphism $\bar{\mathbb{C}} \rightarrow \bar{\mathbb{C}}$). The product $\prod_{g \in G} g \circ F$ is a rational first integral of the multibilliard, since it is invariant under the involutions corresponding to the vertices (by definition) and the dual billiard involution of each tangent line to a multibilliard conic permutes its intersection points with each conic of the pencil. Proposition 2.5 is proved. \square

2.2 Foliation by level curves of rational integral. Proof of Theorems 1.25 and 1.26

Definition 2.6 Consider a rationally integrable dual billiard structure on a complex conic γ (which belongs to the list given by Theorem 1.11). In the case, when it is defined by a pencil of conics, its *canonical integral* is a quadratic rational function constant on each conic of the pencil that vanishes on γ . In the case, when it is exotic, its *canonical integral* is the one given by the Addendum to Theorem 1.11 (whose zero locus is γ).

Proposition 2.7 *Every rational integral of a rationally integrable dual billiard on a conic is constant on each irreducible component of each level curve of its canonical integral.*

Proof Let γ be the conic in question, Ψ be a rational integral of the dual billiard, and let R be its canonical integral. We have to show that $\Psi \equiv \text{const}$ along the leaves of the foliation $R = \text{const}$ (which are, by definition, the irreducible components of level curves of the function R with its critical and indeterminacy points deleted). It suffices to prove the above statement in a small neighborhood of the conic γ . Fix a point $P \in \gamma$ such that it is a regular point for the foliation and the dual billiard involution σ_P is defined there. (In fact, σ_P is well-defined whenever P is regular for the foliation. But we will not use this.) Let $U \subset \mathbb{C}\mathbb{P}^2$ be a small neighborhood of the point P that is a flowbox for the foliation $R = \text{const}$ and whose closure is disjoint from singular points of the foliation and indeterminacy points for the involution family σ_t , $t \in \gamma$. We equip it with biholomorphic coordinates (x, y) , where the local leaves of the flowbox are the horizontal fibers $y = \text{const}$. Fix a point $P_0 \notin \gamma$ close to P . Take a tangent line ℓ_0 to γ through P_0 ; let Q_0 denote the tangency point. Set $P_1 = \sigma_{Q_0}(P_0)$. Let ℓ_1 be the tangent line to γ through P_1 distinct from ℓ_0 , and let Q_1 be their tangency point. Set

$$P_2 = \sigma_{Q_1}(P_1), \text{ etc. } P_N = \sigma_{Q_{N-1}}(P_{N-1}); \quad x_j = x(P_j).$$

Here N is the biggest number such that $P_1, \dots, P_N, Q_0, \dots, Q_{N-1} \in U$. We claim that as $P_0 \rightarrow P$, the cardinality $N = N(P_0)$ of the above sequence tends to infinity. This follows from the fact the involutions $\sigma_Q|_{L_Q}$, $Q \in \gamma \cap U$ are uniformly asymptotic to the central symmetries $x \mapsto 2x(Q) - x$ with respect to the points $x(Q)$, as $x - x(Q) \rightarrow 0$ and $Q \in U$: they are non-trivial conformal involutions of the lines L_Q with fixed points Q . Therefore, N is bigger than the product of the degrees $\deg \Psi \deg R$, whenever P_0 is close enough to P . One has

$$\Psi(P_0) = \dots = \Psi(P_N), \quad R(P_0) = \dots = R(P_N),$$

since both Ψ and R are integrals. This together with Bezout Theorem and the above inequality implies that $\Psi \equiv \text{const}$ along each leaf of the foliation $R = \text{const}$. Proposition 2.7 is proved. \square

Lemma 2.8 *Let R be a rational first integral of an exotic dual billiard structure from Theorem 1.11 given by the corresponding formula in its addendum.*

1) For all but a finite number of values of $\lambda \in \mathbb{C}$ the complex level curve

$$\Gamma_\lambda := \{R = \lambda\}$$

is irreducible of degree $d = \deg R$. In the case, when R is given by (1.7) or (1.8), the curve Γ_λ is irreducible for every $\lambda \neq 0, \infty$.

2) The (punctured) curve $\gamma = \{w = z^2\}$ is a **multiplicity $\frac{d}{2}$ leaf** of the foliation $R = \text{const}$, which means that each small transversal cross-section to γ intersects each leaf close enough to γ (dependently on cross-section) transversely at $\frac{d}{2}$ distinct points; or equivalently, $[\Gamma_\lambda] \rightarrow \frac{d}{2}[\gamma]$ as divisors, as $\lambda \rightarrow 0$.

3) The curve γ is the unique nonlinear multiplicity $\frac{d}{2}$ leaf.

Proof Let us prove Statement 1), on irreducibility. Let us first consider Case 2a1), when $R(z, w) = \frac{(w-z^2)^{2N+1}}{\prod_{j=1}^N (w-c_j z^2)^2}$, see (1.7).

Claim 4. *The germ of the curve Γ_λ at the point $Q = [0 : 1 : 0] \in \mathbb{CP}^2$ (i.e., at the intersection point of the infinity line with the w -axis) is irreducible, whenever $\lambda \neq 0, \infty$.*

Proof Let $\lambda \neq 0, \infty$. In the affine chart $(\tilde{z}, \tilde{w}) = (\frac{z}{w}, \frac{1}{w})$ centered at Q one has

$$\Gamma_\lambda = \{(\tilde{w} - \tilde{z}^2)^{2N+1} - \lambda \tilde{w}^2 \prod_{j=1}^N (\tilde{w} - c_j \tilde{z}^2)^2\}.$$

In the new coordinates (\tilde{z}, u) , $u := \tilde{w} - \tilde{z}^2$, Γ_λ is the zero locus of the polynomial

$$\mathcal{P}_\lambda(\tilde{z}, u) := u^{2N+1} - \lambda(u + \tilde{z}^2)^2 \prod_{j=1}^N (u + (1 - c_j)\tilde{z}^2)^2. \quad (2.3)$$

It suffices to show that the germ of the polynomial \mathcal{P}_λ at the origin is irreducible. To do this, we will deal with its Newton diagram. Namely, consider the bidegrees $(m, n) \in (\mathbb{R}_{\geq 0}^2)_{x,y}$ of all the monomials $\tilde{z}^m u^n$ entering \mathcal{P}_λ . Consider the convex hull of the union of the corresponding quadrants $(m, n) + \mathbb{R}_{\geq 0}^2$. The union \mathcal{ND} of its boundary edges except for the coordinate axes is called the *Newton diagram*. We claim that the Newton diagram of the polynomial \mathcal{P}_λ is one edge $E = [(4N + 4, 0), (0, 2N + 1)]$. Indeed, the bidegrees of the monomials entering \mathcal{P}_λ are $(0, 2N + 1)$ and a collection of bidegrees lying in the line $\{2y + x = 4N + 4\}$, since the multiplier at λ in (2.3) is a $(2, 1)$ -quasihomogeneous polynomial. But the bidegrees lying in the latter line lie above the edge E , except for its vertex $(4N + 4, 0)$. This proves that $\mathcal{ND} = E$.

Suppose the contrary: the germ of the polynomial \mathcal{P}_λ is not irreducible. Then it is the product of two germs of analytic functions with Newton diagrams being edges parallel to E whose endpoints lie in the lattice \mathbb{Z}^2 . The latter edges should be closer to the origin than E and have smaller lengths. But E is the edge of smallest length among all the above edges, since E contains no integer points in its interior: the numbers $4N + 4$ and $2N + 1$ are coprime. The contradiction thus obtained proves irreducibility of the germ of the polynomial \mathcal{P}_λ and hence, Claim 4. \square

Recall that a germ of analytic curve is irreducible, if and only if it is a parametrized curve. This together with Claim 4 implies that for every fixed $\lambda \neq 0, \infty$ there exists a neighborhood $U = U(Q) \subset \mathbb{C}\mathbb{P}^2$ (depending on λ) such that the intersection $\Gamma_{\lambda,U} := \Gamma_\lambda \cap (U \setminus \{Q\})$ is a connected submanifold in $U \setminus \{Q\}$ and every line L close enough to the w -axis intersects $\Gamma_{\lambda,U}$ at $2N + 1$ distinct points. Therefore, all the latter points lie in the same irreducible component of the curve Γ_λ , as $\Gamma_{\lambda,U}$. Hence, the latter component has degree at least $2N + 1$. But the ambient curve Γ_λ has degree at most $2N + 1 = \deg R$. Therefore, Γ_λ coincides with its irreducible component in question, and hence, is irreducible.

Case of integral R given by (1.8) is treated analogously with the following modification: in the above coordinates (\tilde{z}, u) the Newton diagram of the new polynomial \mathcal{P}_λ is $[(2N + 3, 0), (0, N + 1)]$; $2N + 3, N + 1$ are again coprime.

For the proof of Statement 1) of the lemma for the other integrals from the Addendum to Theorem 1.11 it suffices to prove irreducibility of level curve $\{R = \lambda\}$ for an open subset of values λ . We will prove this for generic small λ : for an open set of values λ accumulating to zero. Indeed, it is well-known that if the level curve $\{R = \lambda\}$ of a rational function is irreducible for an open subset of values λ , then it is irreducible for all but a finite number of λ . This is implied by the two following statements:

- each indeterminacy point can be resolved by a sequence of blow-ups, so that the function in question becomes a well-defined $\overline{\mathbb{C}}$ -valued holomorphic function on a new connected compact manifold, a blown-up $\mathbb{C}\mathbb{P}^2$;
- every non-constant holomorphic $\overline{\mathbb{C}}$ -valued function on a connected compact complex manifold has finite number of critical values.

The other canonical rational integrals have degrees 4 or 6 and the type

$$R(z, w) = \frac{(w - z^2)^m}{\Phi(z, w)}, \quad \Phi \text{ is a polynomial, } \deg \Phi = 2m, \quad m \in \{2, 3\}. \quad (2.4)$$

Proposition 2.9 *Let R be as in (2.4). Let there exist a sequence of values λ converging to zero for which the curve $\Gamma_\lambda := \{R = \lambda\}$ is not irreducible.*

Then the foliation $R = \text{const}$ is a pencil of conics.

Proof Passing to a subsequence we can and will consider that one of the following statements holds for all above λ :

- (i) $m = 2$ and Γ_λ is a union of two regular conics $C_{1,\lambda}, C_{2,\lambda}$;
- (ii) Γ_λ contains a line;
- (iii) $m = 3$ and Γ_λ is a union of two regular cubics $C_{1,\lambda}, C_{2,\lambda}$;
- (iv) $m = 3$ and Γ_λ is a union of three regular conics.

Statement (ii) cannot hold: the contrary would imply that the limit conic $\Gamma_0 = \gamma = \{w = z^2\} = \lim_{\lambda \rightarrow 0} \Gamma_\lambda$ contains a line, which is not true. Suppose (iii) holds. Then each cubic considered as a divisor of degree three converge to an integer multiple of the divisor $[\gamma]$ of degree two: thus, to a divisor of even degree. This is obviously impossible. Therefore, the only possible cases are (i) and (iv). The a priori possible intersection points of the conics from (i), (iv) lie in the finite set of indeterminacy and critical points of the rational function R . Therefore, passing to a subsequence one can and will achieve that a family of conics $C_\lambda \subset \Gamma_\lambda$ lies in a pencil. The function R is constant on them for infinite number of values of λ . Therefore, it is constant on each conic of the pencil, since the set of those parameters of the pencil for which $R = \text{const}$ on the corresponding conics is finite (being algebraic). Finally, the foliation $R = \text{const}$ is a pencil of conics. \square

Let R be a degree four integral given by (1.9) or (1.10). We treat only case (1.9), since the integrals (1.9) and (1.10) are obtained one from the other (up to constant factor) by complex projective transformation fixing the conic $\gamma = \{w = z^2\}$. Thus,

$$R = R_{b1}(z, w) = \frac{(w - z^2)^2}{(w + 3z^2)(z - 1)(z - w)}.$$

Suppose the contrary: the curve $\Gamma_\lambda := \{R = \lambda\}$ is not irreducible for a sequence of numbers λ converging to zero. Then the foliation $R = \text{const}$ is a pencil of conics, by Proposition 2.9. It contains the conics γ and $\{w + 3z^2 = 0\}$, which are tangent to each other at the origin and at infinity. Therefore, the pencil consists of conics tangent to them at these points. On the other hand, the line $\{z = 1\}$ lies in the polar locus $\{R = \infty\}$. Hence, it should lie in a conic from the pencil. But this is obviously impossible, – a contradiction.

Let now R be a degree 6 integral from the Addendum to Theorem 1.11, Cases 2c) or 2d). Supposing the contrary to irreducibility, we similarly get that the foliation $R = \text{const}$ is a pencil of conics. But in both Cases 2c) and 2d) the polar locus $\{R = \infty\}$ contains an irreducible cubic, see [27, subsections 7.5, 7.6]. This contradiction proves Statement 1) of Lemma 2.8.

Statement 2) of Lemma 2.8 follows from Statement 1) and the fact that γ is a multiplicity $\frac{d}{2}$ zero curve of the integral R .

Let us prove Statement 3). Suppose the contrary: there exists another leaf α of multiplicity $\frac{d}{2}$ and degree $\mu \geq 2$. Then for every given line L that is transversal to α and does not pass through singularities of the foliation each leaf close enough to α intersects L in at least $\mu \frac{d}{2} \geq d$ points. The number of intersection points cannot be greater than d . Hence, $\mu = 2$ and α is a conic. Let us renormalize the integral R by postcomposition with Möbius transformation ν to an integral $\tilde{R} = \nu \circ R$ so that $\tilde{R}|_\gamma = 0$, $\tilde{R}|_\alpha = \infty$. Let $Y(z, w)$ be a quadratic polynomial vanishing on α . Then

$$\tilde{R} = \left(\frac{z - w^2}{Y(z, w)} \right)^{\frac{d}{2}},$$

up to constant factor, by construction and multiplicity assumption. Therefore, the foliation $\tilde{R} = \text{const}$ is a pencil of conics containing γ and α , and so is $R = \text{const}$. But this is not the case, since its generic leaves are punctured irreducible algebraic curves Γ_λ of degree $d \geq 4$. The contradiction thus obtained proves Lemma 2.8. \square

Proof of Theorem 1.25. Consider a rationally integrable dual multibilliard with integral $\Psi \neq \text{const}$. Then the dual billiard on each its curve γ_j is rationally integrable with integral Ψ . Hence, each γ_j is a conic equipped with either pencil type, or exotic dual billiard structure, by Theorem 1.11, and $\Psi|_{\gamma_j} \equiv \text{const}$, by [27, proposition 1.35] (or by Proposition 2.7).

Case 1). Let some two conics γ_1, γ_2 be the same conic γ equipped with two distinct dual billiard structures, given by projective involution families $\sigma_{P,j} : L_P \rightarrow L_P$, $j = 1, 2$. Here P lies outside a finite set: the union of the indeterminacy loci of families $\sigma_{P,j}$, which are finite by Theorem 1.11. The product $g := \sigma_{P,1} \circ \sigma_{P,2}$ is a parabolic transformation $L_P \rightarrow L_P$, having unique fixed point P . The integral Ψ is g -invariant: $\Psi \circ g = \Psi$ along each line L_P . But each non-fixed point of a parabolic transformation has infinite orbit. Therefore, $\Psi \equiv \text{const}$ along each line tangent to γ . But we know that Ψ is constant along the curve γ , as noted above. Therefore, $\Psi \equiv \text{const}$, by the two latter statements and since the union of lines tangent to γ at points lying in an open subset in γ contains an open subset in \mathbb{CP}^2 . The contradiction thus obtained proves that Case 1) is impossible.

Case 2): there are at least two geometrically distinct conics, say, γ_1, γ_2 . For every $j = 1, 2$ let R_j denote the canonical integral of the corresponding dual billiard structure. We have to prove the two following statements:

1) the dual billiard structure on each γ_j is defined by a pencil of conics, that is, the degree $d_j := \deg R_j$ is equal to 2;

2) the latter pencil is the same for $j = 1, 2$, and it contains both γ_j .

Let \mathcal{F} denote the foliation $\Psi = \text{const}$. For every j for all but a finite number of values $\lambda \in \mathbb{C}$ the complex level curve $\{R_j = \lambda\}$ is irreducible of degree d_j , by Lemma 2.8, and $\Psi \equiv \text{const}$ along it (Proposition 2.7). Hence, each foliation $R_j = \text{const}$ coincides with \mathcal{F} . This together with the previous statement implies that all the degrees d_j are equal, set $d = d_j$, and both (punctured) conics γ_1, γ_2 are leaves of the same multiplicity $\frac{d}{2}$ for the foliation \mathcal{F} . Therefore, the foliation \mathcal{F} is a pencil of conics containing γ_1 and γ_2 , by Statement 3) of Lemma 2.8. Hence, all the conics of the multibilliard lie in this pencil, and $d = 2$ (since d is the degree of irreducible level curve of the function R_1). Thus, each R_j is a ratio of two quadratic polynomials, and its level curves are conics from the pencil. Hence, the dual billiard structure on γ_j is given by the same pencil. Theorem 1.25 is proved. \square

Proof of Theorem 1.27. A rational first integral of a pencil type multibilliard is constant on each conic of the pencil (Proposition 2.7). Moreover, it is constant on every union of those conics whose parameter values λ lie in the same G -orbit. Here G is the group from Proposition 2.4. The cardinality of a generic G -orbit is equal to the cardinality $|G|$ of the group G , since a generic point in $\bar{\mathbb{C}}$ has trivial stabilizer in G . Thus, the minimal degree of the integral (which is achieved, by Proposition 2.5) is $2|G| \in \{2, 4, 12\}$. This together with Proposition 2.4 implies the statement of Theorem 1.27. \square

2.3 Dual billiard structures at vertices. Birationality and types of involutions

Proposition 2.10 *Let A be a point in \mathbb{RP}^2 (\mathbb{CP}^2) equipped with real (complex) dual billiard structure given by involution family $\sigma_{A,\ell}$ that has a real (complex) rational first integral $\Psi \not\equiv \text{const}$: $\Psi \circ \sigma_{A,\ell} = \Psi$ on each line ℓ through A on which the involution is defined. Let the foliation $\Psi = \text{const}$ be not the family of lines through A . Then $\sigma_{A,\ell}$ coincide (up to correction at a finite number of lines ℓ through A) with a birational involution $\sigma_A : \mathbb{CP}^2 \rightarrow \mathbb{CP}^2$ fixing each line through A and holomorphic and bijective on the complement to a finite number of lines through A . The rational integral Ψ and the corresponding foliation $\Psi = \text{const}$ are σ_A -invariant.*

Proof Let $\sigma_{A,\ell} : \ell \rightarrow \ell$ be the corresponding projective involution family acting on lines ℓ through A . They are defined on lines ℓ through A from an open subset $U \in \mathbb{CP}^1$ in complex case ($U \subset \mathbb{RP}^1$ in real case).

Fix a non-linear complex level curve $X := \{\Psi = \lambda\}$. Fix an $\ell_0 \in U$ (consider it as a complex line) such that the points of intersection $X \cap \ell_0$ distinct from A are regular points of the curve X , the intersections are transversal, and the multiplicity of the intersection $X \cap \ell_0$ at A is minimal. There exists a simply connected neighborhood $V = V(\ell_0) \subset \mathbb{CP}^1$ such that for every $\ell \in V$ the number of geometrically distinct points of the set $X_\ell := (X \cap \ell) \setminus \{A\} \subset \mathbb{CP}^2$ is the same (let us denote their number by d), and they depend holomorphically on ℓ (Implicit Function Theorem). We numerate these holomorphic intersection point families by indices $1, \dots, d$. For every $\ell \in V$ the involution $\sigma_{A,\ell}$ makes a (ℓ -dependent) permutation of the latter intersection points, which is identified with a permutation of indices $1, \dots, d$: an element in S_d . There exists a permutation $\alpha \in S_d$ realized by $\sigma_{A,\ell}$ for a continuum cardinality subset $Y \subset V$ of lines. Let us fix it.

Claim 6. *There exists a projective involution family $\tilde{\sigma}_{A,\ell} : \ell \rightarrow \ell$ depending holomorphically on the parameter $\ell \in V$ that makes the permutation α on X_ℓ for every $\ell \in V$. The rational function $\Psi|_\ell$ is $\tilde{\sigma}_{A,\ell}$ -invariant: $\Psi \circ \tilde{\sigma}_{A,\ell} = \Psi$ on every $\ell \in V$.*

Proof Consider first the case, when X_ℓ is just one point. For every $\ell \in V$ set $\tilde{\sigma}_{A,\ell} : \ell \rightarrow \ell$ to be the nontrivial conformal involution fixing the points X_ℓ and A . It depends holomorphically on $\ell \in V$. It preserves $\Psi|_\ell$: $\Psi \circ \tilde{\sigma}_{A,\ell} = \Psi$ on every $\ell \in Y$, and the latter relation holds for every $\ell \in V$, since Y is of cardinality continuum and by uniqueness of analytic extension.

Let now X_ℓ consists of at least two points. Let us define $\tilde{\sigma}_{A,\ell}$ to be the unique projective transformation $\ell \rightarrow \ell$ fixing A and sending the points in X_ℓ with indices 1, 2 to the points with indices $\alpha(1)$, $\alpha(2)$ respectively. For every $\ell \in V$ this is an involution preserving $\Psi|_\ell$, since this is true for every $\ell \in Y$ and by uniqueness of analytic extension. The claim is proved. \square

Claim 7. *The involution family $\tilde{\sigma}_{A,\ell}$ extends holomorphically to a finitely punctured space \mathbb{CP}^1 of lines through A . It coincides with $\sigma_{A,\ell}$ on all the lines $\ell \in U$ except maybe for a finite number of them, on which $\Psi = \text{const}$.*

Proof We can extend the involution family $\tilde{\sigma}_{A,\ell}$ analytically in the parameter ℓ along each path avoiding a finite number of lines ℓ for which either some of the points in X_ℓ are not transversal intersections, or the index of intersection $\ell \cap X$ at A is not the minimal possible. This follows from the previous claim and its proof. Extension along a closed path does not change holomorphic branch. Indeed, otherwise there would exist its another holomorphic branch over a domain $W \subset V$: an involution family $H_{A,\ell} : \ell \rightarrow \ell$ depending holomorphically on $\ell \in W$, $H_{A,\ell} \neq \tilde{\sigma}_{A,\ell}$, which preserves the integral Ψ . The product $F_\ell := \tilde{\sigma}_{A,\ell} \circ H_{A,\ell} : \ell \rightarrow \ell$ is a parabolic projective

transformation, with A being its unique fixed point, for every $\ell \in W$. Its orbits are infinite, and Ψ should be constant along each of them. This implies that $\Psi = \text{const}$ along each line $\ell \in W$. Hence, the foliation $\Psi = \text{const}$ is the family of lines through A , which is forbidden by our assumption. The contradiction thus obtained proves unique definedness of analytic extensions of the involution family $\tilde{\sigma}_{A,\ell}$ along paths and the first statement of the claim. Its second statement follows from the fact that for those $\ell \in U$ for which $\tilde{\sigma}_{A,\ell} \neq \sigma_{A,\ell}$, one has $\Psi \equiv \text{const}$ along ℓ : see the above argument, now with the parabolic transformation $\tilde{\sigma}_{A,\ell} \circ \sigma_{A,\ell}$. The claim is proved. \square

Without loss of generality we consider that $\sigma_{A,\ell} = \tilde{\sigma}_{A,\ell}$, correcting $\sigma_{A,\ell}$ at a finite number of lines. The latter equality defines analytic extension of the involution family $\sigma_{A,\ell}$ to all but a finite number of lines ℓ through A . The invariance condition $\Psi \circ \sigma|_{\ell} = \Psi|_{\ell}$ is a system of algebraic equations on the pairs (ℓ, σ) , where ℓ is a projective line through A and $\sigma : \ell \rightarrow \ell$ is a nontrivial projective involution fixing A . For every line ℓ through A (except for a finite set of lines, including those along which $\Psi \equiv \text{const}$) its solution space is finite, and its cardinality is bounded from above. This implies that the family $\sigma_{A,\ell}$ is a connected open subset in an algebraic subset of a smooth algebraic manifold and all $\sigma_{A,\ell}$ paste together to a global birational automorphism $\mathbb{C}\mathbb{P}^2 \rightarrow \mathbb{C}\mathbb{P}^2$ acting as a holomorphic involution on the complement to a finite number of lines through A . It preserves Ψ , and hence, the foliation $\Psi = \text{const}$, by construction. Proposition 2.10 is proved. \square

Lemma 2.11 *The dual billiard structure at each vertex A of any rationally integrable dual multibilliard is either global, or quasi-global. In the case of quasi-global structure the foliation by level curves of rational integral is a pencil of conics, and the conic of fixed points of the corresponding involution σ_A lies in the same pencil.*

Proof Consider first the case, when the foliation by level curves of integral is a pencil of conics. It is invariant under the birational involution σ_A from Proposition 2.10. Therefore, σ_A acts on its parameter space $\bar{\mathbb{C}}$ as a conformal involution with at least two fixed points. Thus, σ_A fixes at least two distinct conics of the pencil. Fix one of them that is not a pair of lines intersecting at A , let us denote it by Γ . It is possible, since a pencil cannot contain two singular conics, each of them being a pair of lines, so that all the four lines forming them pass through the same point A . Indeed, otherwise A would be the unique base point of the pencil, and the pencil would have type e). Thus, its only singular conic would be the double line tangent to all its regular conics at A , – a contradiction.

Subcase 1.1): Γ is disjoint from A . Then σ_A is a projective involution, by Example 1.17, part 2).

Subcase 1.2): Γ passes through A . If Γ is a union of lines through A , some of its lines, let us denote it by L , does not pass through A . Then σ_A is the projective involution that fixes each point of the line L , by definition. Similarly, if Γ is a regular conic, then σ_A fixes each its point. Hence, it defines a quasi-global dual billiard structure.

Consider now the case, when the foliation by level curves of the integral is not a pencil. Then the multibilliard contains just one conic, let us denote it by γ , equipped with an exotic dual billiard structure. Let R be its canonical integral, $d = \deg R$. The foliation $\Psi = \text{const}$ coincides with $R = \text{const}$, by Proposition 2.7. The (punctured) curve γ being a leaf of multiplicity $\frac{d}{2}$, its (punctured) image $\gamma' := \sigma_A(\gamma)$ is also a multiplicity $\frac{d}{2}$ leaf, since $\Psi \circ \sigma_A = \Psi$ and multiplicity is invariant under birational automorphism of foliation. Hence, γ' coincides with γ , if it is not a line.

Subcase 2.1): $A \notin \gamma$. Then a generic line through A intersects γ at two points distinct from A . Hence, the same holds for the image γ' . Thus, it is not a line, and $\sigma_A(\gamma) = \gamma$. Therefore, σ_A is a global projective transformation, the γ -angular symmetry.

Subcase 2.2): $A \in \gamma$ and $\gamma' \neq \gamma$. Let us show that this case is impossible. Indeed, then γ' is a line, see the above discussion, and $R|_{\gamma'} \neq 0$. Therefore, the points of intersection $\gamma' \cap \gamma$ are indeterminacy points for the function R . In Case 2a) the only indeterminacy points are the origin O and the infinity. Therefore, γ' is some of the following lines: the Ow -axis (which passes through both latter points), the Oz -axis or the infinity line (which are tangent to γ at O and at infinity respectively). But each of the latter lines satisfies at least one of the following statements:

- either R is non-constant there;
- or R has a pole of multiplicity less than d there.

See the two first formulas for the integrals in the addendum to Theorem 1.11. Therefore, the (punctured) line γ' cannot be a multiplicity d leaf of the foliation $R = \text{const}$. This contradiction proves that the case under consideration is impossible. The other Cases 2c), 2d) are treated analogously.

Subcase 2.3): $A \in \gamma = \sigma_A(\gamma)$. Therefore, for every line ℓ through A distinct from the line L tangent to γ at A the involution σ_A fixes the point of intersection $\ell \cap \gamma$ distinct from A . Thus, it is the degenerate γ -angular symmetry. In the chart (x, y) where $\gamma = \{y = x^2\}$, A is the point of the parabola γ at infinity and the line L tangent to γ at A is the infinity line, σ_A acts as

$$\sigma_A : (x, y) \mapsto (x, 2x^2 - y).$$

In the coordinates (x, y) one has

$$R = R(x, y) = \frac{(y - x^2)^m}{F(x, y)}, \quad F(x, y) \text{ is a polynomial, } \deg F \leq 2m. \quad (2.5)$$

To treat the case in question we use the following proposition.

Claim 8. *The point A is an indeterminacy point of the function R .*

Proof Let us first consider the case, when L lies in a level curve $S_\lambda := \{R = \lambda\}$. Then $\lambda \neq 0$, since the zero locus S_λ coincides with γ . Thus, A lies in two distinct level curves, and hence, is an indeterminacy point. Let us now suppose that $R|_L \neq \text{const}$. As a line ℓ through A tends to the tangent line L to γ , its only intersection point $B(\ell)$ with γ distinct from A tends to A . Therefore, the involution $(\sigma_A)|_\ell$, which fixes the confluent points A and $B(\ell)$, tends to the constant map $L \rightarrow A$ uniformly on compact subsets in $L \setminus \{A\}$. Suppose the contrary: A is not an indeterminacy point. Fix a $\lambda \neq 0$. The image $S_{\lambda'} := \sigma_A(S_\lambda)$ is a level curve of the function R , $\lambda' \neq 0$, hence $A \notin S_\lambda, S_{\lambda'}$. Therefore, the points of intersections $\ell \cap S_\lambda, \ell \cap S_{\lambda'}$ do not accumulate to A , as $\ell \rightarrow L$. But the points of the subset $\sigma_A(\ell \cap S_\lambda) \subset S_{\lambda'}$ converge to A , and hence, $A \in S_{\lambda'}$. This contradiction proves the claim. \square

Claim 9. *Let F be the same, as in (2.5). Then*

$$F \circ \sigma_A(x, y) = (-1)^{m+1} F(x, y) + a(x - y^2)^m, \quad a = \text{const} \in \mathbb{C}. \quad (2.6)$$

Proof The involution σ_A is birational, and it permutes leaves of the foliation $R = \text{const}$. All but a finite number of leaves are punctured level curves of the function R , since all but a finite number of level curves are irreducible (Lemma 2.8). Therefore σ_A permutes level curves of the function R and acts on its values by conformal involution $\overline{\mathbb{C}} \rightarrow \overline{\mathbb{C}}$. The latter involution preserves zero, which corresponds to the σ_A -invariant curve γ . Hence, its action on values of the function $\frac{1}{R}$ is either identity, or an affine involution $\mu \mapsto -\mu + b$, $b = \text{const}$. This together with the fact that σ_A changes sign of the polynomial $y - x^2$ implies the statement of the claim. \square

We consider the rational integrals R from the addendum to Theorem 1.11, all their indeterminacy points A and the corresponding involutions σ_A fixing points of γ . For every pair (R, A) , assuming σ_A -invariance of the foliation $R = \text{const}$, we will arrive to contradiction.

Everywhere below by F we denote the denominator of the rational function R (written in the coordinates (z, w) or (x, y) under consideration).

2a1) The integral R given by (1.7). Let A be the infinity point of the parabola $\gamma = \{w = z^2\}$. Then $\sigma_A(z, w) = (z, 2z^2 - w)$. The functions R

and $R \circ \sigma_A$ have the same foliation by level curves. Therefore, their ratio, which is equal to $\pm \frac{F \circ \sigma_A}{F}$, is constant along each leaf. But the latter ratio is constant on the w -axis, since σ_A preserves the degree of higher purely w -term w^k , and z is σ_A -invariant. On the other hand, the w -axis is not a leaf, since $R(0, w) = w^2$. Thus, the above ratio is globally constant, and

$$F \circ \sigma_A = F \text{ up to constant factor.} \quad (2.7)$$

But $F(z, w) = \prod_{j=1}^N (w - c_j z^2)^2$, $F \circ \sigma_A(z, w) = \prod (w - (2 - c_j)z^2)$, the coefficients c_j in F are negative, while the latter coefficients $2 - c_j$ are positive. Therefore, equality (2.7) cannot hold, – a contradiction.

Let $A = O = (0, 0)$. Consider the chart $(x, y) = (\frac{z}{w}, \frac{1}{w})$, in which $A = \infty$,

$$R(x, y) = \frac{(y - x^2)^{2N+1}}{F(x, y)}, \quad F(x, y) = y^2 \prod_{j=1}^N (y - c_j x^2)^2, \quad c_j < 0.$$

Equality (2.7) is proved analogously. The coefficients c_j at x^2 in F are negative. But $F \circ \sigma_A(x, y) = (y - 2z^2) \prod (y - (2 - c_j)x^2)$, and the coefficients at x^2 are positive there. Hence, equality (2.7) cannot hold, – a contradiction.

2a2) Case of integral (1.8). Treated analogously to the above case.

Cases 2b1) and 2b2) have the same complexification; thus we treat only Case 2b2), when the integral R is given by (1.10). There are three indeterminacy points: the infinity and $(\pm i, -1)$. Let $A \in \gamma$ be the infinite point, hence $\sigma_A(z, w) = (z, 2z^2 - w)$. The denominator F is the product of the σ_A -invariant quadratic polynomial $z^2 + 1$ and another quadratic polynomial $\Phi(z, w) = z^2 + w^2 + w + 1$. Therefore, the polynomial $F \circ \sigma_A$ is divisible by $z^2 + 1$, and hence is equal to $\pm F$, by (2.6). This implies that $\Phi \circ \sigma_A = \pm \Phi$ is a quadratic polynomial, while it has obviously degree four, – a contradiction. Let now $A = (\pm i, -1)$. Let B denote the infinite point of the parabola γ . Let us choose an affine chart (x, y) centered at B so that the line tangent to γ at A is the infinity line and the line $\{z = z(A)\}$ is the Oy -axis. In the new coordinates one has $R(x, y) = \frac{(y - x^2)^2}{x\Phi(x, y)}$, where Φ is a cubic polynomial coprime with $y - x^2$. Analogously we get that $\Phi \circ \sigma_A = \pm \Phi$. If Φ contains a monomial divisible by y^2 , then $\deg(\Phi \circ \sigma_A) \geq 4$, and we get a contradiction. Otherwise $\Phi(x, y) = c(y + \Psi(x))$, where Ψ is a polynomial; Φ is coprime with $y - x^2$, hence, $\Psi(x) \neq -x^2$. But then $\Phi \circ \sigma_A \neq \pm \Phi$, – a contradiction.

Cases 2c1) and 2c2). Note that the integral R from 2c1) is invariant under the order 3 group generated by the symmetry $(z, w) \mapsto (\varepsilon z, \varepsilon^2 w)$, where ε is a cubic root of unity. This group acts transitively on the set of three indeterminacy points. Thus, it suffices to treat the case of just one

indeterminacy point A . Again it suffices to treat only Case 2c2), which has the same complexification, as Case 2c1), with A being the infinite point of the parabola γ . To do this, let us first recall that the $(2, 1)$ -quasihomogeneous degree of a monomial $z^m w^n$ is the number $m+2n$. A polynomial is $(2, 1)$ -quasihomogeneous, if all its monomials have the same $(2, 1)$ -quasihomogeneous degree. Each polynomial in two variables is uniquely presented as a finite sum of $(2, 1)$ -quasihomogeneous polynomials of distinct quasihomogeneous degrees. The indeterminacy points of the integral R given by (1.12) are $O = (0, 0)$, $(1, 1)$ and the infinity point of the parabola γ .

Taking composition with $\sigma_A(z, w) = (z, 2z^2 - w)$ preserves the quasihomogeneous degrees. The lower quasihomogeneous part of the denominator F in (1.12) is the polynomial $(w + 8z^2)^2$ of quasihomogeneous degree 4. The numerator $(w - z^2)^3$ is quasihomogeneous of degree 6. Therefore, the lower quasihomogeneous part of the polynomial $F \circ \sigma_A$ is the polynomial $(w - 10z^2)^2 \neq \pm(w + 8z^2)^2$. The two latter statement together imply that formula (2.6) cannot hold, – a contradiction.

Case 2d). Then we have three indeterminacy points: the origin, the infinity point and the point $(1, 1)$. The case, when A is the infinity point of the parabola γ , is treated analogously to Case 2b2). Let us consider the case, when A is the origin. In the coordinates $(x, y) = (\frac{z}{w}, \frac{1}{w})$ the function R takes the form $R(x, y) = \frac{(y-x^2)^3}{F(x, y)}$,

$$F(x, y) = (y + 8x^2)(x - y)(y^2 + 8x^2y + 4y + 5x^2 - 14xy - 4x^3).$$

The lower $(2, 1)$ -quasihomogeneous part of the polynomial F is $V(x, y) := x(y+8x^2)(4y+5x^2)$. It has quasihomogeneous degree 5, while the numerator in R has quasihomogeneous degree 6. This together with (2.6) implies that σ_A multiplies the lower quasihomogeneous part by ± 1 . But $V \circ \sigma_A(x, y) = x(y - 10x^2)(4y - 13x^2) \neq \pm V(x, y)$, – a contradiction.

Let us now consider the case, when $A = (1, 1)$. Take the affine coordinates (x, y) centered at the infinite point of the parabola γ such that the complement to the affine chart (x, y) is the tangent line L to γ at A and the y -axis is the zero line $\{z = 1\}$ of the denominator (which passes through A). The rational function R takes the form

$$R(x, y) = \frac{(y - x^2)^3}{F(x, y)}, \quad F(x, y) = xG_2(x, y)G_3(x, y), \quad G_j(0, y) \neq 0, \quad \deg G_j = j,$$

$$G_2(x, y) = w + z^2, \quad G_3(x, y) = w + 8z^2 + 4w^2 + 5wz^2 - 14zw - 4z^3.$$

In the chart (x, y) one has $\sigma_A(x, y) = (x, 2x^2 - y)$. The factor x in F is σ_A -invariant. Therefore, $F \circ \sigma_A = \pm F$, by (2.6), and σ_A leaves invariant the

zero locus $Z = \{G_2G_3 = 0\}$. The latter zero locus is a union of the conic $\{G_2 = 0\}$ disjoint from A and a cubic $\{G_3 = 0\}$. The latter intersects a generic line ℓ through A at a unique point distinct from A , since it has a cusp at A , see [27, subsection 7.6, claim 9]. Thus, for a generic line ℓ through A , the intersection $Z \cap (\ell \setminus \{A\})$ consists of three distinct points disjoint from γ and it is invariant under the involution σ_A . This implies that one of them is fixed; let us denote it by B . Hence, for a generic ℓ the projective involution $(\sigma_A)|_\ell$ has three distinct fixed points: A , B and the unique point of the intersection $\gamma \cap (\ell \setminus \{A\})$. Therefore, it is identity, – a contradiction. Thus, we have checked that a rationally integrable dual multibilliard with exotic foliation $R = \text{const}$ cannot have a vertex A whose involution σ_A is not a global projective transformation. This proves Lemma 2.11. \square

2.4 Pencil case. Proof of Theorem 1.26

We already know that if a dual multibilliard is of pencil type, then it is rationally integrable (Proposition 2.5). Consider now an arbitrary rationally integrable dual multibilliard where all the curves are conics equipped with a dual billiard structure defined by the same pencil (containing each conic of the multibilliard). Let us show that the multibilliard is of pencil type, that is, its vertices (if any) are from the list given by Definition 1.21 and their collection satisfies the conditions of Definition 1.23.

Proposition 2.12 *Let a rationally integrable multibilliard consist of conics lying in a pencil, equipped with dual billiard structures defined by the same pencil, and some vertices. Then each its vertex is admissible for the pencil.*

Proof Let Ψ be a rational integral of the multibilliard, $\Psi \neq \text{const}$. The foliation $\Psi = \text{const}$ coincides with the pencil under consideration, by Proposition 2.7. Let K be a vertex of the multibilliard. Then its dual billiard structure is given by an involution $\sigma_K : \mathbb{CP}^2 \rightarrow \mathbb{CP}^2$ preserving the pencil that is either a global projective involution, or an involution fixing points of a regular conic α passing through K and lying in the pencil (Lemma 2.11).

Let us first treat the second case, when σ_K fixes points of a regular conic α from the pencil. Let L denote the tangent line to α at K . Consider the affine chart (z, w) on the complement $\mathbb{CP}^2 \setminus L$ in which $\alpha = \{w = z^2\}$; the point K is the intersection of the infinity line with the w -axis. One has $\sigma_K(z, w) = (z, 2z^2 - w)$. Each regular conic β of the pencil is given by a quadratic equation $\{w + \Phi_2(z) = 0\}$, where Φ_2 is a quadratic polynomial. Indeed, the quadratic equation on β contain neither w^2 , nor wz terms, since

σ_K transforms them to polynomials of degrees four and three respectively, while it should send β to a conic of the pencil. This implies that all the regular conics of the pencil are tangent to each other at K , and we get that K is an admissible vertex from Definition 1.21.

Let us now treat the first case, when σ_K is a global projective involution.

Claim 10. *Let K be not a base point of the pencil. Then the conic \mathcal{S} through K is a pair of lines.*

Proof The conic \mathcal{S} is fixed by σ_K , as is K . If it were regular, then it would intersect a generic line ℓ through K at a point distinct from K , and the involution σ_K would fix each point in \mathcal{S} . Thus, it would not be a projective transformation, – a contradiction. \square

Subcase 1): K is not a base point of the pencil, and the conic \mathcal{S} through A is a pair of distinct lines L_1, L_2 , both passing through K . In the case, when the pencil consists of conics passing through four distinct base points, there are two base points V_{j1}, V_{j2} in each line L_j . Therefore, K is a standard vertex M_s from Definition 1.21, and the projective involution σ_K permutes V_{j1}, V_{j2} for every $j = 1, 2$. Hence, σ_K coincides with the involution σ_{M_s} from Definition 1.21, Case a). In the case, when the pencil has three distinct base points, two of them lie in one of the lines, say L_1 , the third one (denoted by C) lies in L_2 , and L_2 is tangent at C to all the regular conics of the pencil. We get analogously that $K = M$ and $\sigma_K = \sigma_M$, see Definition 1.21, Case b). Case c), when the conics of the pencil are tangent to each other at two base points, is treated analogously. Case e) is impossible, since then the pencil contains no distinct line pair. In Case d) it contains the unique pair of distinct lines. They intersect at a base point: the common tangency point of conics. Hence, this case is impossible.

Subcase 2): K is not a base point, the conic \mathcal{S} consists of a line L_1 through K and a line L_2 that does not pass through K . Then σ_K fixes K and each point of the line L_2 , and hence, the intersection point $M = L_1 \cap L_2$. In Case a) there are two base points in each line L_j . Those lying in L_1 should be permuted by σ_K . Therefore, the points K, M and the two base points in L_1 form a harmonic quadruple. Hence K is one of the skew vertices from Definition 1.21, Case a). In Case b) there are three distinct base points. The case, when two of them lie in L_1 , is treated as above. In the case, when L_1 contains only one base point C , it should be tangent there to the regular conics of the pencil, and C should be fixed by σ_K , as is M . Therefore, $C = M$, since the projective involution $(\sigma_K)|_{L_1}$ cannot have three distinct fixed points C, M, K . Finally, all the three base points are contained in the line L_2 , which is obviously impossible. Similarly in Case c) we get that K

is a point of the line through the two base points A, C . Indeed, the other a priori possible subcase is when K lies in a line tangent to the conics at a base point (say, A). Then σ_K would fix three points of the latter line: K, A and the intersection point of the tangent lines to conics at A and C . The contradiction thus obtained shows that this subcase is impossible.

In Case d) (conics tangent at a point A with triple contact and passing through another point B) the point K should lie in the line L tangent to the conics at A . (This realizes the vertex C from Subcase d2) in Definition 1.21.) Indeed, otherwise K would lie in $AB \setminus \{A, B\}$, and the involution σ_K would fix three distinct points $A, B, K \in AB$, – a contradiction. Case e) is impossible, since then the pencil contains no distinct line pair.

Subcase 3): K is not a base point, and the conic \mathcal{S} is a double line L through K . Then

- either the pencil is of type c) and L passes through the two base points; the involution σ_K should permute them and the tangent lines at them to the conics of the pencil;

- or the pencil is of type e) and L is tangent to its regular conics at the unique base point; the involution should fix K and those points where the tangent lines to conics pass through K ; the latter points form a line through the base point.

Both cases are realized by vertices from Definition 1.21.

Subcase 4): K is a base point. Then each line L passing through K and another base point A contains no more base points. Thus, the involution $(\sigma_K)|_L$ should fix both K and A . Finally, σ_K fixes each base point. Therefore, the base points different from K lie on the fixed point line Λ of the projective involution σ_K . Let the pencil be of type a). Then Λ contains three base points, – a contradiction. Let now the pencil have type b). Then Λ contains two base points. If the conics of the pencil are tangent to each other at K , the vertex K has type b3) from Definition 1.21. Consider the opposite case, when the common tangency point C of the conics lies in Λ . Let H denote their tangent line at C . Then H contains no other base point, thus, $H \neq KC, \Lambda$. Hence, the restriction of the involution σ_K to each line $\ell \neq KC$ through K fixes three distinct points: $K, \ell \cap H, \ell \cap \Lambda$. The contradiction thus obtained proves that the case under consideration is impossible. Case of pencil of type c) is treated analogously: K is a vertex of type c2).

Consider the case of pencil of type d). Let K be the base point of transversal intersection of conics. Then the involution σ_K , which preserves the pencil, should fix K and each point of the common tangent line L to the conics at the other base point A . In an affine chart (z, w) centered at A , in which K is the intersection point of the infinity line with the Ow -axis and L

is the z -axis, the involution σ_K is the symmetry with respect to the z -axis. The latter symmetry changes the 2-jet of a regular conic of the pencil at A . But its conics should have the same 2nd jet at A . Hence, σ_K cannot preserve the pencil, – a contradiction. Therefore, K is the base point where the conics have a common tangent line L , and the other base point B (of transversal intersection) lies in Λ . Let us choose an affine chart (z, w) so that L is the infinity line, K is its intersection with the Ow -axis, and Λ is the z -axis. Then σ_K is again the symmetry as above, and it changes 2nd jets of conics (which are parabolas) at their infinity point K . Therefore, Case d) is impossible. Case e) is treated analogously to the latter discussion.

Finally, all the possible vertices listed above belong to the list of admissible vertices from Definition 1.21. Proposition 2.12 is proved. \square

The rational integral of the multibilliard is constant on each union of conics of the pencil whose parameter values form a G -orbit, and the double cardinality $2|G|$ is no greater than the degree of the integral: see the proof of Theorem 1.27 at the end of Subsection 2.2. Therefore, G is finite. Hence, the multibilliard is of pencil type, by Proposition 2.4. Theorem 1.26 is proved.

2.5 Exotic multibilliards. Proof of Theorem 1.31

Proposition 2.13 *Each multibilliard from Theorem 1.31 is rationally integrable. The corresponding rational function R from the addendum to Theorem 1.11 is its integral of minimal degree, except for the subcase in Case (i), when $\rho = 2 - \frac{1}{N+1}$; in this subcase R^2 is a first integral of minimal degree.*

Proof In the case, when there are no vertices, rational integrability follows by Theorem 1.11. Let us consider that the multibilliard contains at least one admissible vertex.

Case (i). The function R (respectively, R^2) is a rational integral of minimal degree, since R is even (odd) in z .

Case (ii) is treated analogously to Case (i). It suffices to treat the subcase 2b2), since the multibilliards of types 2b1), 2b2) containing the unique admissible vertex are projectively isomorphic (Proposition 1.32). In subcase 2b2) the function R is even in z , and hence, invariant under the corresponding admissible vertex involution $(z, w) \mapsto (-z, w)$.

Case (iii). Let us show that the γ -angular symmetry σ_Q centered at each admissible vertex Q preserves the integral R . Cases 2c1) and 2c2) being complex-projectively isomorphic and invariant under order three symmetry cyclically permuting the three singular points, we treat Case 2c2), with $Q = (0, -1)$ being the intersection point of the w -axis (i.e., the line through

two indeterminacy points: O and ∞) and the line tangent to γ at the indeterminacy point $(1, 1)$. We use the following two claims and proposition.

Claim 11. *The polar locus*

$$S := \{P(z, w) = 8z^3 - 8z^2w - 8z^2 - w^2 - w + 10zw = 0\}$$

passes through $Q = (0, -1)$ and has an inflection point there.

Proof One has $Q = (0, -1) \in S$ (straightforward calculation). To show that Q is an inflection point, it suffices to show that $\nabla P(Q) \neq 0$ and the Hessian form of the function P evaluated on the skew gradient $(\frac{\partial P}{\partial w}, -\frac{\partial P}{\partial z})$ (which is a function of Q denoted by $H(P)(Q)$) vanishes at Q . Indeed,

$$\frac{\partial P}{\partial z}(Q) = -10, \quad \frac{\partial P}{\partial w}(Q) = 2 - 1 = 1,$$

$$\frac{\partial^2 P}{\partial z^2}(Q) = 0, \quad \frac{\partial^2 P}{\partial w^2}(Q) = -2, \quad \frac{\partial^2 P}{\partial z \partial w}(Q) = 10,$$

$$H(P) = \frac{\partial^2 P}{\partial z^2} \left(\frac{\partial P}{\partial w} \right)^2 + \frac{\partial^2 P}{\partial w^2} \left(\frac{\partial P}{\partial z} \right)^2 - 2 \frac{\partial^2 P}{\partial z \partial w} \frac{\partial P}{\partial w} \frac{\partial P}{\partial z} = 0 - 200 + 200 = 0$$

at the point Q . The claim is proved. \square

Proposition 2.14 *Let a cubic $S \subset \mathbb{CP}^2$ have an inflection point Q . Then there exists a projective involution $\sigma_{Q,S} : \mathbb{CP}^2 \rightarrow \mathbb{CP}^2$ that fixes each line through Q and permutes its intersection points with S distinct from Q (for ℓ being not the tangent line to S at Q).*

Proof The above involution is well-defined on each line ℓ through Q distinct from the tangent line Λ to S at Q as a projective involution $\sigma_{Q,S,\ell} : \ell \rightarrow \ell$ depending holomorphically on $\ell \neq \Lambda$. It suffices to show that the involution family thus obtained extends holomorphically to $\ell = \Lambda$. This will imply that $\sigma_{Q,S}$ is a well-defined global holomorphic involution $\mathbb{CP}^2 \rightarrow \mathbb{CP}^2$, and hence, a projective transformation. Indeed, let us take an affine chart (x, y) centered at Q and adapted to S , so that Λ is the Ox -axis and the germ of the cubic S is the graph of a germ of holomorphic function:

$$y = f(x), \quad f(x) = ax^3 + (b + o(1))x^4; \quad S = \{y = f(x)\}.$$

A line $\ell_\delta := \{y = \delta x\}$ with small slope δ intersects S at two points distinct from $Q = (0, 0)$ with x -coordinates x_0, x_1 satisfying the equation

$$ax_0^2 + (b + o(1))x_0^3 = ax_1^2 + (b + o(1))x_1^3 = \delta. \quad (2.8)$$

Taking square root and expressing x_1 as an implicit function $-x_0(1 + o(1))$ of x_0 yields

$$x_1 = -x_0 + (c + o(1))x_0^2, \quad c = -\frac{b}{a}.$$

Writing the projective involution $\sigma_{Q,S} : \ell_\delta \rightarrow \ell_\delta$ fixing the origin and permuting the above intersection points as a fractional-linear transformation in the coordinate x , we get a transformation

$$x \mapsto -\frac{x}{1 + \nu(\delta)x}. \quad (2.9)$$

Substituting x_0 to (2.9) yields

$$-\frac{x_0}{1 + \nu(\delta)x_0} = -x_0 + (c + o(1))x_0^2;$$

$$(1 + \nu(\delta)x_0)(1 - (c + o(1))x_0) = 1, \quad x_0 = x_0(\delta) \rightarrow 0,$$

as $\delta \rightarrow 0$. Therefore, $\nu(\delta) = c + o(1) \rightarrow c$, and the one-parametric holomorphic family of transformation (2.9) extends holomorphically to $\delta = 0$ as the projective transformation $x \mapsto -\frac{x}{1+cx}$ (continuity and Erasing Singularity Theorem). The proposition is proved. \square

Claim 12. *The polar cubic S is σ_Q -invariant.*

Proof The projective involution $\sigma_{Q,S}$ from Proposition 2.14 fixes S and each line through Q . It preserves the conic γ , which is the unique regular conic tangent to S at the three indeterminacy points of the integral R . Indeed, if there were two such distinct conics, then their total intersection index at the three latter points would be no less than 6, – a contradiction to Bézout Theorem. Therefore, $\sigma_{Q,S}$ is the γ -angular symmetry, and hence, it coincides with σ_Q . This implies that $\sigma_Q(S) = S$. The claim is proved. \square

Claim 12 together with σ_Q -invariance of the zero locus γ of the rational function R implies that $R \circ \sigma_Q = \pm R$. The restriction of the integral R to the line ℓ through Q tangent to the conic γ at the point $(1, 1)$ is holomorphic and nonconstant at $(1, 1)$, since its numerator being restricted to ℓ has order 6 zero at $(1, 1)$, and so does its denominator. The point $(1, 1)$ is fixed by σ_Q . Therefore, the above equality holds with sign "+" near the point $(1, 1)$, and hence, everywhere. Case iv) is treated. The proposition is proved. \square

Recall that in our case of a multibilliard containing a conic with an exotic dual billiard structure, the involution associated to each vertex is a projective angular symmetry (Lemma 2.11). As it is shown below, this together with the next proposition implies Theorem 1.31.

Proposition 2.15 *Consider an exotic rationally integrable dual billiard on a conic γ . Let R be its canonical integral. Let $A \in \mathbb{CP}^2$, and let $\sigma_A : \mathbb{CP}^2 \rightarrow \mathbb{CP}^2$ be a projective angular symmetry centered at A that preserves the foliation $R = \text{const}$. Then σ_A is the γ -angular symmetry centered at A , and A belongs to the list from Theorem 1.31.*

Proof Set $d = \deg R \in 2\mathbb{N}$. The (punctured) conic γ is the only conical leaf of multiplicity $\frac{d}{2}$ of the foliation $R = \text{const}$, see the proof of Lemma 2.11. Therefore, $\sigma_A(\gamma) = \gamma$. Hence, $A \notin \gamma$, since σ_A is a projective involution. Thus, its restriction to each line ℓ through A permutes its intersection points with γ . Hence, σ_A is the γ -angular symmetry centered at A . It preserves the set of indeterminacy points of the integral R , whose number is either two, or three, since it preserves the foliation $R = \text{const}$. Hence, it preserves the union of lines tangent to γ at the indeterminacy points.

Consider first Case 2a), where there are two indeterminacy points: in the affine chart (z, w) these are the origin O and the infinity point B of the parabola γ . Let L_O, L_B denote the lines tangent to γ at O and at B respectively, and let Q be their intersection point. Let us show that $A = Q$: this is Case (i) from Theorem 1.31. The infinity line L_B is a leaf of the foliation $R = \text{const}$, while L_O isn't. Therefore, the lines L_B and L_O are σ_A -invariant. Suppose the contrary: $A \neq Q$. Say, $A \notin L_O$; the case $A \notin L_B$ is treated analogously. Then the restriction of the involution σ_A to each line $\ell \neq L_B, L_O$ through A fixes A and its intersection points distinct from A with the lines L_O, L_B and OB . The number of the latter points is at least two, unless A is one of their pairwise intersection points $Q, O, B \in \gamma$. But $A \neq O, B$, since $A \notin \gamma$, and $A \neq Q$ by assumption, – a contradiction. Thus, $A = Q$.

Case 2b). Then there are three indeterminacy points, and we can name them by X, Y, Z so that $R|_{YZ} \equiv \text{const} \neq \infty$, while $R|_{XY}, R|_{XZ} \equiv \infty$. In Subcase 2b1) $X = (1, 1)$, and Y, Z are the origin and the infinity point of the parabola γ . The involution σ_A should fix one of the indeterminacy points and permute two other ones. We claim that it fixes X and permutes Y and Z . Indeed, suppose the contrary: σ_A fixes, say, Y and permutes X and Z . Then $\sigma_A(XY) = YZ$ and $\sigma_A(XZ) = XZ$. On the other hand, σ_A should send level sets of the integral R to its level sets, since this is true for generic, irreducible level sets of degree $\deg R$, and remains valid after passing to limit. Thus, σ_A should preserve the infinity level set, since $\sigma_A(XZ) = XZ$. On the other hand, it should permute it with a finite level set containing the line YZ , since $\sigma_A(XY) = YZ$. The contradiction thus obtained proves that $\sigma_A(X) = X$ and $\sigma_A(Y) = Z$. This implies that A is

the intersection point of the line YZ with the tangent line to γ at X , and the corresponding involution σ_A permutes the intersection point of each line through A with the lines XY and XZ . Thus, the pair (A, σ_A) is the same, as in the Cases (ii) of Theorem 1.31. These cases are obtained one from the other by complex projective transformation, as in Theorem 1.12.

Case 2c1). (Case 2c2) is obtained from it by projective transformation.) The integral R has three indeterminacy points lying on the conic γ . Let us denote them by X, Y, Z . Then one of them, say, X , is fixed by the γ -angular symmetry σ_A , and the two other ones are permuted. Indeed, if all of them were fixed, then the three distinct tangent lines to γ at them would intersect at the point Q , which is impossible: through every point lying outside the conic γ there are only two tangent lines to γ . This implies that A is the intersection point of the line tangent to γ at X and the line YZ . Thus, it is admissible in the sense of Theorem 1.31, case (iii).

In Case 2c2) all the admissible vertices are real, since so are the indeterminacy points. In Case 2c1) $X = (1, 1)$ is the unique real indeterminacy point; the other ones are $Y = (\varepsilon, \bar{\varepsilon})$ and $Z = (\bar{\varepsilon}, \varepsilon)$, where $\varepsilon = e^{\frac{2\pi i}{3}}$. The intersection of the line $\{w = 2z - 1\}$ tangent to γ at $(1, 1)$ and the line YZ is the admissible vertex $(0, -1)$. Each one of the complex lines XZ, XY has non-real slope, and hence, X is its unique real point. Therefore, the admissible vertex lying there is not real. Thus, in Case 2c1) the point $(0, -1)$ is the unique real admissible vertex.

Case 2d). The corresponding integral $R = R_d$ has three indeterminacy points: the origin, the point $(1, 1)$ and the infinity point of the conic γ . The line $\{z = 1\}$ through the two latter indeterminacy points lies in a level curve of the integral R : namely, in its polar locus. On the other hand, R is non-constant on the lines $\{z = 0\}$ and $\{z = w\}$ passing through the origin and the other indeterminacy points. This implies that every projective transformation preserving the foliation $R = \text{const}$ should fix the origin, and hence, the Oz -axis: the corresponding tangent line to γ . Let us show that it cannot be a γ -angular symmetry. Suppose the contrary: it is the γ -angular symmetry σ_A centered at a point A . Then σ_A has to fix the origin and to permute the two other indeterminacy points, as in the case discussed above. Therefore, A is the intersection point of the line $\{z = 1\}$ through them and the Oz -axis: thus, $A = (1, 0)$. Thus, the involution σ_A fixes the line $\{z = 1\}$, which lies in the polar locus of the integral R . Hence, it preserves the whole polar locus, as in the above Case 2b). The polar locus consists of the above line, the regular conic $\alpha := \{w = -8z^2\}$ and an irreducible rational cubic, see [27, proposition 7.15]. Hence, σ_A fixes the conic α . Hence,

it permutes its infinite point (coinciding with that of γ) and its other, finite intersection point $(1, -8)$ with the line $\{z = 1\}$. On the other hand, it should send the infinite point to the other point $(1, 1) \in \gamma \cap \{z = 1\}$, since σ_A is the γ -angular symmetry. The contradiction thus obtained proves that if a multibilliard contains a conic with exotic dual billiard structure of type 2d), then it contains no vertices. The proof of Theorem 1.31 is complete. \square

Proof of Proposition 1.32. The complex projective equivalence of billiards of type (ii) is obvious. Let us prove the analogous second statement of Proposition 1.32 on billiards of type (iii). The dual billiard structure on γ of type 2c1) admits the order 3 symmetry $(z, w) \mapsto (\varepsilon z, \bar{\varepsilon} w)$ cyclically permuting the indeterminacy points of the integral. Therefore, it also permutes cyclically admissible vertices and hence, acts transitively on them and on their unordered pairs. The same statement holds for type 2c2), since the dual billiards 2c1) and 2c2) are complex-projectively isomorphic. This implies the second statement of Proposition 1.32. In the case of type 2c2) the indeterminacy points are real, and hence, so are the admissible vertices, and the order 3 symmetry is a real projective transformation. This together with the above discussion implies the third statement of Proposition 1.32. \square

2.6 Admissible vertices of real pencils of conics. Proof of Proposition 1.24

Proof of Proposition 1.24. The ambient projective plane $\mathbb{C}\mathbb{P}^2$ is the projectivization of a three-dimensional complex space \mathbb{C}^3 . The complex conjugation involution acting on \mathbb{C}^3 induces its action on $\mathbb{C}\mathbb{P}^2$, which will be also called conjugation. It sends projective lines to projective lines and preserves the complexification of every real pencil of conics.

Case a): pencil of real conics through four distinct (may be complex) points A, B, C, D . The conjugation permutes the points A, B, C, D . Therefore, it permutes vertices M_1, M_2 and M_3 . Hence, at least one of them is fixed (say, M_1), or equivalently, real. The line through the other points M_2, M_3 should be fixed, and thus, real, since the union $\{M_2, M_3\}$ is invariant. Finally, the involution σ_{M_1} is real.

Let now the point K_{AB} be real. Then the ambient line AB is invariant under the conjugation, since the collection of complex lines through pairs of permuted basic points of the pencil is invariant. Therefore, it is a real line, the union $\{A, B\}$ is conjugation invariant. Hence, so is $\{C, D\}$, and the line CD is real. Thus, the involution $\sigma_{K_{AB}}$ is also real.

Note that the case, when C, D are real and A, B aren't is possible. In

this case A and B are permuted by the conjugation. Hence, the points M_2 and M_3 are also permuted, and thus, they are not real. Similarly, K_{BC} and K_{AC} are permuted, K_{BD} and K_{AD} are permuted, and hence, they are not real.

Case b): real pencil of conics through 3 points A, B, C tangent at the point C to the same line L . See Fig. 4. The point C and the line L should be obviously fixed by conjugation, and hence, real. Therefore, the points A, B are either both fixed, or permuted. Hence, the line AB is real, and so is the intersection point $M = AB \cap L$. The point $K_{AB} \in AB$ is also real, since complex conjugation acting on complex projective line sends harmonic quadruples to harmonic quadruples and the harmonicity property of a quadruple of points is invariant under two transpositions: one permuting its two first points; the other one permuting its two last points. Therefore, the line CK_{AB} is real, and so is σ_M . The global projective involutions σ_C and $\sigma_{K_{AB}}$ are both real, since so are the lines AB and L . In the case, when the dual billiard structure at C is quasi-global and is defined by a real conic, the corresponding involution σ_C is real.

Case c): real pencil of conics through two distinct points A, C tangent at them to two given lines L_A and L_C . See Fig. 5. A priori, the points A and C need not be real. For example, a pencil of concentric circles satisfies the above statements with $A = [1 : i : 0]$, $C = [1 : -i : 0]$: the so-called isotropic points at infinity. The line AC is real, and so is $M = L_A \cap L_C$, since the complex conjugation either permutes A and C (and hence, the lines L_A and L_C), or fixes them. Therefore, the involution σ_M is real. The point M' , which is an arbitrary point of the complex line AC needs not be real. But if it is real, then so is the involution $\sigma_{M'}$. Indeed, $\sigma_{M'}$ can be equivalently defined to fix M' and the line through M and the point $K \in AC$ for which the quadruple M', K, A, C is harmonic. If M' is real, then so is K , as in the above case. Hence, the line MK is real and so is $\sigma_{M'}$.

Cases d) and e). Reality of the vertex A , is obvious. Equivalence of reality of the involution $\sigma_{A,\mathcal{S}}$ and reality of the conic \mathcal{S} , follows from reality of the vertex A and from the fact that a projective involution of a complex line having at least one real fixed point is real, if and only if its other fixed point is also real. Proposition 1.24 is proved. \square

3 Rationally 0-homogeneously integrable piecewise smooth projective billiards. Proof of Theorems 1.38, 1.39, 1.45

The first step of the above-mentioned classification is the following lemma.

Lemma 3.1 *Let a planar projective billiard with piecewise C^4 -smooth boundary containing a nonlinear arc be rationally 0-homogeneously integrable. Then the C^4 -smooth pieces of its boundary are conical arcs and straight-line segments. The projective billiard structure of each conical arc is either of dual pencil type, or an exotic one from Statement 2) of Theorem 1.16.*

Proof A rational 0-homogeneous integral of the billiard is automatically such an integral for the projective billiard on each nonlinear arc. Hence, by Theorem 1.16, the nonlinear arcs are conics, and each of them is equipped with a projective billiard structure either of dual pencil type, or exotic. \square

Below we describe the possible combinations of conical arcs and straight-line segments equipped with projective billiard structures that yield altogether a rationally integrable projective billiard. We reduce this description to the classification of rationally integrable dual multibilliards. To do this, we use the projective duality given by orthogonal polarity, see Subsection 3.1, which transforms a projective billiard to a dual multibilliard. We show that the former is rationally 0-homogeneously integrable, if and only if the latter is rationally integrable. We present a one-to-one correspondence between rational 0-homogeneous integrals of the former and rational integrals of the latter. Afterwards the main results on classification of rationally 0-homogeneously integrable projective billiards follow immediately by duality from those on dual multibilliards.

3.1 Duality between projective billiards and dual multibilliards. Correspondence between integrals

Consider the orthogonal polarity, which sends each two-dimensional subspace in the Euclidean space $\mathbb{R}_{x_1, x_2, x_3}^3$ to its orthogonal one-dimensional subspace. The projectivization of this correspondence is a projective duality that sends each projective line in $\mathbb{RP}_{[x_1: x_2: x_3]}^2$ to a point in \mathbb{RP}^2 , called its dual point. It sends an immersed smooth² strictly convex curve α to its

²Note that in general, the straightforward parametrization of the dual curve α^* induced by a C^m -smooth parametrization of the curve α is not C^m -smooth. But one can choose the parameter of the dual curve to make it C^m -smooth.

dual: the immersed smooth strictly convex curve α^* , whose points are dual to the projective lines tangent to α .

Consider a projective billiard in \mathbb{R}_{x_1, x_2}^2 with piecewise C^4 -smooth boundary such that each its C^4 -smooth arc is either strictly convex, or a straight-line segment. This holds automatically, if all the nonlinear boundary arcs are conical, as in Lemma 3.1. Consider the ambient plane \mathbb{R}_{x_1, x_2}^2 as the horizontal plane $\{x_3 = 1\} \subset \mathbb{R}_{x_1, x_2, x_3}^3$. We identify it with the standard affine chart $\{x_3 = 1\} \in \mathbb{RP}_{[x_1: x_2: x_3]}^2$ by tautological projection. The above duality sends each nonlinear C^4 -smooth boundary arc α to the dual curve $\alpha^* \subset \mathbb{RP}^2$. For every point $Q \in \alpha$ let L_Q denote the projective line tangent to α at Q . Let Q^* denote the line dual to Q . It is tangent to the dual curve α^* at the point $P = L_Q^*$ dual to L_Q . The projective billiard reflection at Q is the nontrivial affine involution acting on $T_Q \mathbb{R}^2$, which fixes the points of the line L_Q and fixes the line $\mathcal{N}(Q)$ of the transversal line field. Its projectivization acts as an involution $\mathbb{RP}^1 \rightarrow \mathbb{RP}^1$ on the space \mathbb{RP}^1 of lines through Q . The duality conjugates the latter involution acting on lines to a projective involution σ_P acting on the projective line $Q^* = L_P$ tangent to α^* at P and fixing the points P and $\mathcal{N}^*(Q)$. The projective involution family $(\sigma_P)_{P \in \alpha^*}$ thus obtained is a dual billiard structure on the curve α^* . It will be called the *dual billiard structure dual to the projective billiard on α* .

Definition 3.2 Consider a projective billiard as above. Its *dual multibilliard* is the collection of curves α^* in \mathbb{RP}^2 dual to its C^4 -smooth nonlinear boundary arcs α , equipped with the dual billiard structure defined above, and the points A (called *vertices*) dual to the ambient lines a of the straight-line billiard boundary segments. Each vertex A is equipped with the following dual billiard structure. Let U denote the union of all the billiard boundary intervals lying in the line a . Each point $Q \in U$ is dual to a line q through A . The projective billiard reflection involution acting on the space \mathbb{RP}^1 of lines through Q is conjugated by duality to a projective involution $\sigma_{A, q} : q \rightarrow q$ fixing A . The family of involutions $\sigma_{A, q}$, $Q \in U$, yields the prescribed dual billiard structure at the point A .

For every $(x_1, x_2) \in \mathbb{R}^2$ and $(v_1, v_2) \in T_{(x_1, x_2)} \mathbb{R}^2$ set

$$r := (x_1, x_2, 1), \quad v = (v_1, v_2, 0) \in \mathbb{R}^3,$$

$$\mathcal{M} = \mathcal{M}(r, v) := [r, v] = (-v_2, v_1, \Delta), \quad \Delta = \Delta(x_1, x_2, v) = x_1 v_2 - x_2 v_1. \tag{3.1}$$

For every fixed r the map \mathcal{M} is a linear operator sending the space $T_{(x_1, x_2)} \mathbb{R}^2$ isomorphically onto the orthogonal complement r^\perp . Its projectivization

sends the space of lines in \mathbb{R}^2 through r onto the projective line dual to the point $(x_1, x_2) = [x_1 : x_2 : 1] \in \mathbb{R}^2 \subset \mathbb{RP}^2$. Each line through r is sent onto its dual point. Therefore, the projectivized map \mathcal{M} yields a well-defined map from the space of projective lines to \mathbb{RP}^2 that coincides with the above projective duality. In particular, it conjugates the projective billiard reflections at billiard boundary points to the corresponding dual multibilliard involutions. Therefore, we can consider that the dual multibilliard lies in the projective plane \mathbb{RP}^2 with homogeneous coordinates $[\mathcal{M}_1 : \mathcal{M}_2 : \mathcal{M}_3]$.

Proposition 3.3 *1) A projective billiard is rationally 0-homogeneously integrable, if and only if its dual multibilliard is rationally integrable.*

2) Each rational 0-homogeneous integral of degree n (if any) of the projective billiard is a rational 0-homogeneous function of the moment vector $\mathcal{M} = (\mathcal{M}_1, \mathcal{M}_2, \mathcal{M}_3)$, see (3.1), of the same degree n .

3) Let R be a rational integral of the dual multibilliard written in homogeneous coordinates $[\mathcal{M}_1 : \mathcal{M}_2 : \mathcal{M}_3]$ as a ratio of two homogeneous polynomials of degree n . Then $R[r, v]$ is a rational 0-homogeneous integral of the projective billiard of the same degree n .

Proof The statements of the proposition extend [27, propositions 1.23, 1.24] (formulated for a projective billiard on a connected curve) to projective billiards with piecewise C^4 -smooth boundary. The proofs given in [27, subsections 9.1, 9.2] remain valid in this more general case. \square

Corollary 3.4 *The minimal degree of rational 0-homogeneous integral of a projective billiard is equal to the minimal degree of rational integral of its dual multibilliard.*

3.2 Case of dual pencil. Proof of Theorems 1.38, 1.39, 1.40

We use the following proposition.

Proposition 3.5 *Let \mathcal{P} be a pencil of conics, \mathcal{P}^* be its dual pencil.*

1) Let $\alpha \subset \mathbb{R}^2 \subset \mathbb{RP}^2$ be a conical arc whose ambient conic lies in \mathcal{P}^ , equipped with the projective billiard structure defined by \mathcal{P}^* . Then its dual is the dual conical arc α^* equipped by the dual billiard structure of pencil type, defined by the pencil \mathcal{P} . The converse statement also holds.*

2) A planar projective billiard is of dual pencil type, defined by the dual pencil \mathcal{P}^ , if and only if its dual multibilliard is of pencil type, defined by \mathcal{P} .*

Proof Statement 1) of the proposition follows from definition. The definitions of dual multibilliard of pencil type and projective billiard of dual pencil type are dual to each other: the standard (skew) admissible lines for the dual pencil \mathcal{P}^* are dual to the standard (skew) admissible vertices for the pencil \mathcal{P} . This implies Statement 2). \square

Proof of Theorem 1.38. Let a projective billiard with piecewise C^4 -smooth boundary containing a nonlinear arc be rationally integrable. Then its dual multibilliard is rationally integrable (Proposition 3.3). Hence, all its curves are conics, and the nonlinear arcs of projective billiard boundary are conical. Let there be at least two arcs of two distinct conics. Then the multibilliard contains their dual conics, which are also distinct. Hence, they are equipped with the dual billiard structure defined by the pencil \mathcal{P} containing them, each conic of the multibilliard lies in the same pencil \mathcal{P} and is equipped with the dual billiard structure defined by \mathcal{P} (Theorem 1.25). Thus, all the conical arcs of the projective billiard boundary lie in the dual pencil \mathcal{P}^* and are equipped with the projective billiard structures defined by \mathcal{P}^* , by Proposition 3.5, Statement 1). Theorem 1.38 is proved. \square

Proof of Theorem 1.39. Let in a projective billiard all the nonlinear boundary arcs be conics lying in the same dual pencil \mathcal{P}^* , equipped with the projective billiard structure defined by \mathcal{P}^* . Then the curves of the dual multibilliard are conics lying in the pencil \mathcal{P} , equipped with the dual billiard structure defined by \mathcal{P} . The projective billiard is rationally 0-homogeneously integrable, if and only if the dual multibilliard is rationally integrable, by Proposition 3.3, Statement 1). The latter holds, if and only if the multibilliard is of pencil type (Theorem 1.26). Or equivalently, if and only if the projective billiard is of dual pencil type, see Proposition 3.5, Statement 2). Theorem 1.39 is proved. \square

Theorem 1.40 follows immediately from Theorem 1.27 and Corollary 3.4 by duality, since (neighbor) skew admissible lines for a dual pencil \mathcal{P}^* are dual to (neighbor) skew admissible vertices for the pencil \mathcal{P} and vice versa.

3.3 Exotic projective billiards. Proof of Theorem 1.45

Let a projective billiard has boundary that consists of conical arcs of one and the same conic equipped with an exotic dual billiard structure from Theorem 1.16, Case 2), and maybe some straightline segments. It is rationally 0-homogeneously integrable, if and only if the corresponding dual multibilliard is rationally integrable, by Proposition 3.3, Statement 1). In appropriate coordinates the dual multibilliard consists of one conic $\gamma =$

$\{w = z^2\} \subset \mathbb{R}_{z,w}^2 = \{t = 1\} \subset \mathbb{RP}_{[z:w:t]}^2$ equipped with the corresponding exotic dual billiard structure from Theorem 1.11 and maybe some vertices. It is rationally integrable, if and only if either it has no vertices, or each its vertex is admissible in the sense of Theorem 1.31. This holds if and only if the ambient lines of the projective billiard boundary segments are dual to the admissible vertices, and their corresponding projective billiard structures are dual to the dual billiard structures at the vertices. The lines dual to the admissible vertices, equipped with the corresponding dual projective billiard structures, will be called admissible. Let us find the admissible lines case by case. To do this, we use the following proposition.

Proposition 3.6 *Consider the above parabola γ equipped with an exotic dual billiard structure from Theorem 1.11, Case 2). Let $C \subset \mathbb{RP}_{[z:w:t]}^2$ denote the conic orthogonal-polar-dual to γ .*

1) *The projectivization $[F] : \mathbb{RP}_{[z:w:t]}^2 \rightarrow \mathbb{RP}_{[x_1:x_2:x_3]}^2$ of the linear map*

$$F : (z, w, t) \mapsto (x_1, x_2, x_3) := \left(\frac{z}{2}, t, w\right) \quad (3.2)$$

sends C to the parabola $\{x_2x_3 = x_1^2\}$, which will be now referred to, as C ,

$$C \cap \{x_3 = 1\} = \{x_2 = x_1^2\},$$

equipped with the corresponding projective billiard structure from Theorem 1.16, Case 2).

2) *For every point $(z_0, z_0^2) \in \gamma$ the corresponding point of the dual curve C has $[x_1 : x_2 : x_3]$ -coordinates $[-z_0 : z_0^2 : 1]$.*

3) *The points in C corresponding to $O = (0, 0)$, $(1, 1)$, $\infty \in \gamma$ are respectively $[0 : 0 : 1] = (0, 0)$, $[-1 : 1 : 1] = (-1, 1)$, $[0 : 1 : 0] = \infty$ in the coordinates $[x_1 : x_2 : x_3]$ and in the coordinates (x_1, x_2) in the affine chart $\mathbb{R}_{x_1, x_2}^2 = \{x_3 = 1\}$.*

Proof Statements 1) and 2) follow from [27, claim 14, subsection 9.4] and the discussion after it. Statement 3) follows from Statement 2). \square

Case 2a). The only admissible vertex of the dual billiard on γ is the intersection point $Q = [1 : 0 : 0]$ of the tangent lines to γ at the origin and the infinity. It is equipped with the projective involution $[z : w : t] \mapsto [-z : w : t]$ fixing the points of the line Ow through the origin and the infinity. The duality sends the above tangent lines to the origin and to the infinity respectively in the coordinates (x_1, x_2) . Thus, the dual line Q^* is the line through the origin and the infinity, equipped with the field of lines through the point $[1 : 0 : 0]$: the horizontal line field orthogonal to it.

Case 2b1) (Case 2b2) is treated analogously). The only admissible vertex $Q = (0, -1)$ is the intersection point of the tangent line to γ at the point $(1, 1)$ and the line Ow through the origin and the infinity. The dual point to the above tangent line is $(-1, 1)$, by Proposition 3.6, Statement 3). The dual to the Ow -axis is the infinity point $[1 : 0 : 0]$: the intersection point of the tangent lines at the origin and at the infinity. Therefore, the line Q^* dual to Q is the line $\{x_2 = 1\}$ through the points $(-1, 1)$ and $[1 : 0 : 0]$. Let us find the corresponding dual projective billiard structure on it. The fixed point line of the involution σ_Q is the line $L = \{w = 1\}$. Indeed, σ_Q fixes γ , and hence, the tangency points of the lines through Q tangent to γ . The latter tangency points are $(\pm 1, 1)$. Hence, the fixed point line is the line L through them. The line L intersects γ at the points $(\pm 1, 1)$. Their dual lines are tangent to C at the points $(\pm 1, 1)$, by Proposition 3.6, Statement 3). Therefore, the dual point L^* is the intersection point $(0, -1)$ of the latter tangent lines. Finally, the admissible line $Q^* = \{x_2 = 1\}$ is equipped with the field of lines through the point $(0, -1)$.

Case 2c2). The dual billiard structure on the conic γ has three base (indeterminacy) points: $(0, 0)$, $(1, 1)$, ∞ . Each admissible vertex is the intersection point of a line tangent to γ at one of them and the line through two other ones. The admissible vertices are $(1, 0)$, $(0, -1)$ and $[1 : 1 : 0]$. Let us find their dual lines and the projective billiard structures on them. The point $Q = (1, 0)$ is the intersection point of the Oz -axis (which is tangent to γ at $(0, 0)$) and the line $\{z = 1\}$ (which is the line through the points $(1, 1)$ and ∞). The dual point to the Oz -axis is the origin $(0, 0)$. The dual point to the line $\{z = 1\}$ is the point $[-1 : 2 : 0]$. Indeed, it is the point of intersection of the lines tangent to C at the points $(-1, 1)$ and infinity, by Proposition 3.6, Statement 3). The latter intersection point is $[-1 : 2 : 0]$, since the line tangent to C at $(-1, 1)$ has slope -2 . Finally, the admissible line Q^* dual to Q is the line $\{x_2 = -2x_1\}$ through the origin and the point $[-1 : 2 : 0]$. Let us find its projective billiard structure. The lines through Q tangent to γ are the Oz -axis and the line $\{x_2 = 2(x_1 - 1)\}$, with tangency points $(0, 0)$ and $(2, 4)$ respectively. Therefore, the fixed point line of the involution σ_Q is the line $L = \{w = 2z\}$ through them. Its dual point L^* is the intersection of the lines dual to $(0, 0), (2, 4) \in \gamma$. The latter lines are tangent to C at the points $(0, 0)$ and $(-2, 4)$, by Proposition 3.6, Statement 3), and they intersect at $(-1, 0)$. Thus, $L^* = (-1, 0)$, and the admissible line $Q^* = \{x_2 = -2x_1\}$ is equipped with the field of lines through $L^* = (-1, 0)$.

The line dual to the admissible vertex $(0, -1)$ is the line $\{x_2 = 1\}$ equipped with the field of lines through the point $(0, -1)$, as in Case 2b1).

The admissible vertex $[1 : 1 : 0]$ is the intersection point of the line

tangent to γ at infinity and the line through the points $(0, 0)$ and $(1, 1)$. Therefore, its dual line passes through infinity (i.e., is parallel to the Ox_2 -axis) and the intersection point of the tangent lines to C at the corresponding points $(0, 0)$ and $(-1, 1)$. The latter intersection point is $(-\frac{1}{2}, 0)$. Hence, the line dual to $[1 : 1 : 0]$ is $\{x_1 = -\frac{1}{2}\}$. It intersects the conic C at two points: the infinity and the point $(-\frac{1}{2}, \frac{1}{4})$. Its projective billiard structure is the field of lines through the intersection point of the tangent lines to C at the two latter points, as in the above cases. Their intersection point is $[-1 : 1 : 0]$, since the slope of the tangent line to C at $(-\frac{1}{2}, \frac{1}{4})$ is equal to -1 . Finally, the admissible line $[1 : 1 : 0]^* = \{x_1 = -\frac{1}{2}\}$ is equipped with the line field parallel to the vector $(-1, 1)$.

Case 2c1). Then $(0, -1)$ is the unique admissible vertex for the dual billiard. The only admissible line is its dual line $\{x_2 = 1\}$ equipped with the field of lines through the point $(0, -1)$, as in Cases 2c2) and 2b1).

Case 2d). There are no admissible lines, since the dual billiard has no admissible vertices (Theorem 1.31). Theorem 1.45 is proved.

4 Integrals of dual pencil type billiards: examples of degrees 4 and 12. Proof of Theorems 1.28, 1.41 and Lemma 1.42

First we prove Theorems 1.28, 1.41 and Lemma 1.42. Then we provide examples of dual pencil type projective billiards with integrals of degrees 4 and 12. Afterwards we discuss their realization by the so-called semi-(pseudo-) Euclidean billiards, with nonlinear part of boundary being equipped with normal line field for the standard (pseudo-) Euclidean form.

4.1 Multibilliards of pencil type. Proof of Theorem 1.28

For every admissible vertex V from Definition 1.21, Case a) (M_j or K_{EL}) equipped with the corresponding projective involution σ_V , let $\widehat{V} : \mathbb{R}^3 \rightarrow \mathbb{R}^3$ denote the linear involution whose projectivization is σ_V . We normalize it to fix the points of the two-dimensional subspace projected to the fixed point line of σ_V and to act as the central symmetry $\alpha \mapsto -\alpha$ on the one-dimensional subspace projected to V . Let \widehat{V}^* denote its conjugate, acting on the space \mathbb{R}^{3*} of linear functionals on \mathbb{R}^3 . The symmetric square $\text{Sym}^2(\mathbb{R}^{3*})$ is identified with the space of homogeneous quadratic polynomials on \mathbb{R}^3 . The operators \widehat{V}^* lifted to $\text{Sym}^2(\mathbb{R}^{3*})$ will be also denoted by \widehat{V}^* . In the proof of Theorem 1.28 we use the two following propositions.

Proposition 4.1 *Let a pencil have type 2a): conics through four different points A, B, C, D . One has*

$$(\widehat{K}_{EL}\widehat{K}_{LF})^3 = Id \quad \text{for every three distinct } E, L, F \in \{A, B, C, D\}. \quad (4.1)$$

Proof Let $N \in \{A, B, C, D\}$ be the point distinct from E, L, F . The involutions $\sigma_{K_{EL}}, \sigma_{K_{LF}}$ fix N ; $\sigma_{K_{EL}}$ fixes F and permutes E, L ; $\sigma_{K_{LF}}$ fixes E and permutes L, F . Hence, their product fixes N and makes an order three cyclic permutation of the points E, L, F . Thus, $\Pi := (\sigma_{K_{EL}} \circ \sigma_{K_{LF}})^3$ fixes all the four points $A, B, C, D \in \mathbb{RP}^2$, hence $\Pi = Id$. Thus, $(\widehat{K}_{EL}\widehat{K}_{LF})^3 = Id$ up to constant factor. The latter constant factor should be equal to one, since the operator in question has unit determinant, being a product of six involutions \widehat{K}_{ST} , each with determinant -1 . This proves (4.1). \square

Recall that for every line $X \subset \mathbb{RP}^2$ by $\xi_X \in \mathbb{R}^{3*}$ we denote a linear functional vanishing on the two-dimensional subspace in \mathbb{R}^3 projected to X .

Proposition 4.2 *1) The subspace $W \subset \text{Sym}^2(\mathbb{R}^{3*})$ generated by the products $\xi_{EL}(Y)\xi_{(EL)'}(Y)$ with $(EL)'$ being the line through the pair of points $\{E', L'\} := \{A, B, C, D\} \setminus \{E, L\}$, is two-dimensional and \widehat{V}^* -invariant for every admissible vertex V . Each operator \widehat{V}^* corresponding to a standard admissible vertex acts on W as the identity up to constant factor.*

2) The above functionals ξ_{EL} can be normalized so that

$$\widehat{K}_{AB}^*(\xi_{AB}\xi_{CD}) = -\xi_{AB}\xi_{CD}, \quad \widehat{K}_{AB}^*(\xi_{BC}\xi_{AD}) = -\xi_{AC}\xi_{BD}, \quad (4.2)$$

and so that analogous formulas hold for the other operators \widehat{K}_{EL}^ .*

Proof The zero conics of the polynomials $\xi_{EL}(Y)\xi_{(EL)'}(Y)$ are the singular conics $AB \cup CD, BC \cup AD, AC \cup BD$. They lie in the pencil of conics through A, B, C, D . Hence the space W spanned by these polynomials is two-dimensional. Its \widehat{V}^* -invariance follows from σ_V -invariance of the pencil. For every $V \in \{M_1, M_2, M_3\}$ the involution σ_V fixes the three above conics, and hence, each conic of the pencil. Thus $\widehat{V}^*|_W = Id$ up to constant factor.

Let us prove the first formula in (4.2) for arbitrary normalization of the functionals ξ_{AB} and ξ_{CD} . Every vector $v \in \mathbb{R}^3 \setminus \{0\}$ with $\pi(v) \notin AB \cup CD$ is sent by \widehat{K}_{AB} to the opposite side from the hyperplane $\pi^{-1}(CD)$ and to the same side from the hyperplane $\pi^{-1}(AB)$, by definition: \widehat{K}_{AB} fixes the points of the former hyperplane and acts as central symmetry on its complementary invariant subspace $\pi^{-1}(K_{AB})$, which lies in the latter hyperplane. Therefore, it keeps the sign of the functional ξ_{AB} and changes the sign of ξ_{CD} . Hence, it multiplies their product by -1 , being an involution.

The operator \widehat{K}_{AB} permutes the conics $BC \cup AD$ and $AC \cup BD$. Therefore, the functionals ξ_{BC} , ξ_{AD} , ξ_{AC} , ξ_{BD} can be normalized so that the corresponding products $\xi_{BC}\xi_{AD}$ and $\xi_{AC}\xi_{BD}$ be permuted by \widehat{K}_{AB}^* with change of sign. Formula (4.2) is proved. Let us normalize ξ_{AB} and ξ_{CD} by constant factors (this does not change formula (4.2)) so that the analogue of the second formula in (4.2) holds for \widehat{K}_{BC}^* :

$$\widehat{K}_{BC}^*(\xi_{AC}\xi_{BD}) = -\xi_{AB}\xi_{CD}. \quad (4.3)$$

This together with the second formula in (4.2) and involutivity of the operators \widehat{V}^* imply that

$$\widehat{K}_{BC}^*\widehat{K}_{AB}^*(\xi_{AC}\xi_{BD}) = -\widehat{K}_{BC}^*(\xi_{BC}\xi_{AD}) = \xi_{BC}\xi_{AD}. \quad (4.4)$$

Replacing the right-hand side in (4.3) by $\widehat{K}_{AB}^*(\xi_{AB}\xi_{CD})$, applying \widehat{K}_{BC}^* to both sides, denoting $H := \widehat{K}_{BC}^*\widehat{K}_{AB}^*$, together with (4.4) yield

$$H(\xi_{AB}\xi_{CD}) = \xi_{AC}\xi_{BD}, \quad H(\xi_{AC}\xi_{BD}) = \xi_{BC}\xi_{AD}. \quad (4.5)$$

One also has

$$H(\xi_{BC}\xi_{AD}) = \xi_{AB}\xi_{CD}, \quad (4.6)$$

since $H^3 = Id$, by (4.1). Therefore,

$$\xi_{AC}\xi_{BD} + \xi_{BC}\xi_{AD} + \xi_{AB}\xi_{CD} = 0 \quad (4.7)$$

since the terms in the latter sum form an orbit of order three two-dimensional operator acting on W . Let us now prove the analogues of formula (4.2) for the other K_{EL} . To this end, let us show that

$$\widehat{K}_{CD}^* = \widehat{K}_{AB}^* \quad \text{on the space } W. \quad (4.8)$$

Indeed, the composition $\sigma_{K_{CD}} \circ \sigma_{K_{AB}}$ fixes the three singular conics (and hence, each conic of the pencil), by definition. Therefore, $\widehat{K}_{CD}^* = \widehat{K}_{AB}^*$ on W , up to constant factor. The latter constant factor is equal to one, since the operators in question take equal value at $\xi_{AB}\xi_{CD}$, by the first formula in (4.2) (which holds for K_{AB} replaced by K_{CD}). This proves (4.8). Formula (4.8) together with the other similar formulas, and already proved formula (4.2) for the operators \widehat{K}_{AB}^* , \widehat{K}_{BC}^* imply the analogues of (4.2) for \widehat{K}_{CD}^* , \widehat{K}_{DA}^* . Let us prove its analogue for \widehat{K}_{AC}^* . One has

$$\widehat{K}_{BC}^*\widehat{K}_{AC}^*(\xi_{AC}\xi_{BD}) = -\widehat{K}_{BC}^*(\xi_{AC}\xi_{BD}) = \xi_{AB}\xi_{CD}, \quad (4.9)$$

by formula (4.2) for K_{BC} . Therefore, $\xi_{AC}\xi_{BD}$, $\xi_{AB}\xi_{CD}$ together with a third vector $\widehat{K}_{BC}^*\widehat{K}_{AC}^*(\xi_{AB}\xi_{CD})$ form the orbit of order three linear operator $\widehat{K}_{BC}^*\widehat{K}_{AC}^*$, see (4.1). The sum of the vectors in the orbit should be equal to zero. This together with (4.7) implies that

$$\widehat{K}_{BC}^*\widehat{K}_{AC}^*(\xi_{AB}\xi_{CD}) = \xi_{BC}\xi_{AD}.$$

Applying \widehat{K}_{BC}^* to this equality yields $\widehat{K}_{AC}^*(\xi_{AB}\xi_{CD}) = -\xi_{BC}\xi_{AD}$. Formula (4.2) for K_{AC} is proved. For K_{BD} it follows from its version for K_{AC} as above. Formula (4.2) is proved for all K_{EL} . Proposition 4.2 is proved. \square

Claim. *For the normalization chosen as in Proposition 4.2 formula (1.21), i.e., (4.7) holds. Conversely, if (4.7) holds, then the statements of Proposition 4.2 also hold. Relation (4.7) determines the collection of products $\xi_{EL}\xi_{FN}$ uniquely up to common constant factor.*

Proof The first statement of the claim is already proved above. Its third, uniqueness statement follows from two-dimensionality of the space W . These two statements together imply the second statement of the claim. \square

Proof of Theorem 1.28. Let the linear functionals ξ_{EL} be normalized to satisfy (1.21), which is possible by Proposition 4.2 and the above claim. Then they satisfy (4.2), by the claim. Projective transformations of \mathbb{RP}^2 act on rational functions on \mathbb{RP}^2 (which can be represented as rational 0-homogeneous functions of $Y = (y_1, y_2, y_3)$). The ratio $\frac{\xi_{AB}\xi_{CD}}{\xi_{BC}\xi_{AD}}$ is sent by $\sigma_{K_{AB}}$ to $\frac{\xi_{AB}\xi_{CD}}{\xi_{AC}\xi_{BD}}$ etc., by (4.2). This implies invariance of the degree 12 rational function (1.22) under all the involutions $\sigma_{K_{EL}}$. Its invariance under the involutions corresponding to the standard vertices follows from Proposition 4.2, Statement 1). Thus, the integral in question is invariant under the involutions of all the admissible vertices. It is invariant under the involution of tangent line to a conic of the multibilliard, since so are its factors, which are constant on the conics of the pencil. Theorem 1.28 is proved. \square

4.2 Dual pencil type projective billiards. Proof of Theorem 1.41 and Lemma 1.42

Proof of Theorem 1.41. Consider a dual pencil type projective billiard given by a dual pencil of conics tangent to four distinct lines a, b, c, d . Consider the corresponding dual multibilliard in $\mathbb{RP}^2_{[\mathcal{M}_1:\mathcal{M}_2:\mathcal{M}_3]}$ obtained by orthogonal polarity duality. It is of pencil type, defined by the pencil of conics through the points A, B, C, D dual to the latter lines. Expression (1.25) considered as a rational 0-homogeneous function of \mathcal{M} is a well-defined

function on \mathbb{RP}^2 . It is a rational integral of the multibilliard, provided that relation (1.24) holds. There indeed exist $\chi_{em;fn}$ satisfying (1.24), by Theorem 1.28 and since each scalar product $\langle r(en), \mathcal{M} \rangle$ is a linear functional vanishing on the two-dimensional subspace $\pi^{-1}(EN) \subset \mathbb{R}^3$ corresponding to the line $EN: r(en) \perp \pi^{-1}(EN)$, by orthogonal polarity duality. Therefore, substituting $\mathcal{M} = [r, v]$ to (1.25) yields an integral of the projective billiard, by Proposition 3.3, Statement 3). Theorem 1.41 is proved. \square

Proof of Lemma 1.42. Let us find $\chi_{em;fn}$ from linear equations implied by (1.24). Substituting $\mathcal{M} = (0, 0, 1)$ to (1.24) yields

$$\sum \chi_{em;fn} = 0. \quad (4.10)$$

For every intersection point em set

$$x(em) := (x_1(em), x_2(em)) \in \mathbb{R}^2.$$

Let now $\mathcal{M} \perp r(ab)$. Then there exists a $v = (v_1, v_2) = (v_1, v_2, 0)$ such that

$$\mathcal{M} = [r(ab), v] = (-v_2, v_1, \Delta_{ab}), \quad \Delta_{ab} := [x(ab), v] = x_1(ab)v_2 - x_2(ab)v_1, \quad (4.11)$$

since $v \mapsto [r, v]$ is a linear isomorphism $\mathbb{R}^2 \rightarrow r^\perp$. Substituting (4.11) to (1.24) yields

$$\begin{aligned} & \chi_{bc;ad}[x(bc) - x(ab), v][x(ad) - x(ab), v] \\ & + \chi_{ac;bd}[x(ac) - x(ab), v][x(bd) - x(ab), v] = 0. \end{aligned} \quad (4.12)$$

The vector differences $(x(bc) - x(ab), x(bd) - x(ab))$ in (4.12) are proportional (being parallel to the line b), and so are the other vector differences (parallel to a). Therefore, equality (4.12) is equivalent to the relation

$$\chi_{bc;ad}\rho\tau + \chi_{ac;bd}st = 0. \quad (4.13)$$

Combining (4.13) with (4.10) and normalizing the $\chi_{em;fn}$ so that $\chi_{ac;bd} = 1$ yields (1.27). Lemma 1.42 is proved. \square

Remark 4.3 The $\chi_{em;fn}$ satisfying (1.24) can be also found by all the possible substitutions $\mathcal{M} \perp r(em)$ for $em = ab, bc, cd, ac, bd, ad$. This yields a system of linear equations. It appears that their matrix has rank two, so that there exists a unique common non-zero solution. Namely, all the 3x3-minors vanish. This follows from two-dimensionality of the subspace W generated by the three quadratic forms $\langle r(em), \mathcal{M} \rangle \langle r(fn), \mathcal{M} \rangle$, which in its turn follows from the fact that *the three singular conics* $AB \cup CD$,

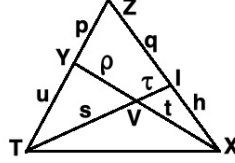

Figure 19:

$AC \cup BD$, $AD \cup BC$ formed by the lines EM dual to the points em lie in the same pencil of conics through the points A, B, C, D . On the other hand, a direct calculation of 3×3 -minors of the matrix of linear equations and equating these minors to zero yields relations on the (oriented) lengths $s, \tau, \rho, t, p = |cd - bc|$, $u = |bc - ac|$, $q = |cd - ad|$, $h = |ad - bd|$, see Fig. 15. These relations are given by the following geometric theorem, which can also be deduced from Sine Theorem. The author believes that this theorem is well-known, but he did not found a reference to it.

Theorem 4.4 *In a triangle XZT , see Fig. 19, let us take arbitrary points Y, I on its sides ZT and XZ respectively. Let V denote the intersection point of the lines XY and TI . Set*

$$\begin{aligned} \rho &:= |YV|, \quad t := |VX|, \quad s := |TV|, \quad \tau := |VI|, \\ u &:= |TY|, \quad p := |YZ|, \quad q := |IZ|, \quad h := |XI|. \end{aligned}$$

Then

$$\frac{pq}{(p+u)(q+h)} = \frac{\rho\tau}{st}, \quad \frac{tp}{(\rho+t)(p+u)} = \frac{\tau}{s+\tau}, \quad \frac{sq}{(s+\tau)(q+h)} = \frac{\rho}{\rho+t}.$$

4.3 Generic dual pencil type projective billiards with integrals of degrees 4 and 12

Let us construct explicit examples of dual pencil type projective billiards with minimal degree of integral being equal to 4 and 12, with non-degenerate dual pencil. Consider a dual pencil of conics tangent to four given distinct lines: a, b, c, d . Fix some its conic γ . We consider that it is a closed curve in \mathbb{R}^2 . Let us equip it with the projective billiard structure defined by the pencil: the conics of the pencil are its complex caustics. Let us construct the corresponding admissible lines m_1, m_2, m_3 and k_{ef} , $e, f \in \{a, b, c, d\}$, $e \neq f$, equipped with their central projective billiard structures. We consider that the intersection points ab, bc, cd, da of the tangent lines

form a convex quadrilateral in which γ is inscribed. Then the lines k_{ac} and k_{bd} both intersect the convex domain bounded by γ , see Figures 20 and 21.

Example 4.5 of projective billiards with integral of degree 4. The line k_{ac} cuts the domain bounded by γ into two pieces. Each of them is a projective billiard bounded by an arc of the curve γ and a segment of the line k_{ac} , both equipped with the corresponding projective billiard structures. Both these projective billiards are rationally integrable with minimal degree of integral equal to four (Theorems 1.39 and 1.40). See Fig. 20. However the tangency points (marked in bold) of the curve γ with the lines a, b, c, d are indeterminacy points of the projective billiard structure on γ . But in each piece we can split its boundary arc lying in γ into open subarcs separated by the tangency points. The projective billiard structure is well-defined on the latter subarcs, and we can consider them as smaller smooth pieces of the boundary. A way to exclude the indeterminacy points from the boundary is to cut by the line m_2 and to consider a smaller domain, bounded by segments of the lines k_{ac}, m_2 and an arc of the curve γ , now without indeterminacies on smooth boundary arcs (except for the "corners"). This yields a curvilinear triangle equipped with a projective billiard structure, also admitting a rational integral of minimal degree 4.

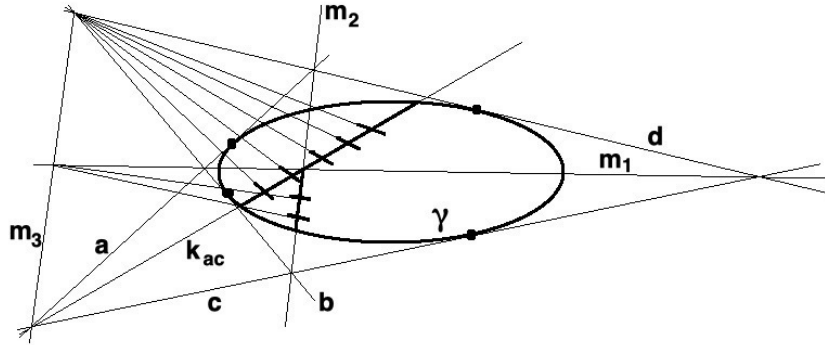

Figure 20: Three projective billiards (with boundaries marked in bold) with rational integral of minimal degree 4. The indeterminacies of the projective billiard structure on γ are marked in bold.

Example 4.6 with integral of degree 12. Consider the two curvilinear quadrilaterals with boundaries marked in bold at Fig. 21 as projective

billiards. The first one is bounded by segments of the lines k_{ad} , k_{bd} , m_2 and an arc of the conic γ . The second one is bounded by segments of the lines k_{bd} , k_{ab} , k_{ac} and an arc of the conic γ . (We need to note that the boundary arc in γ in at least some of them contains (at least one) tangency point, which is an indeterminacy point of the projective billiard structure.) Both quadrilaterals considered as projective billiards are rationally integrable with minimal degree of integral being equal to 12, by Theorems 1.39 and 1.40.

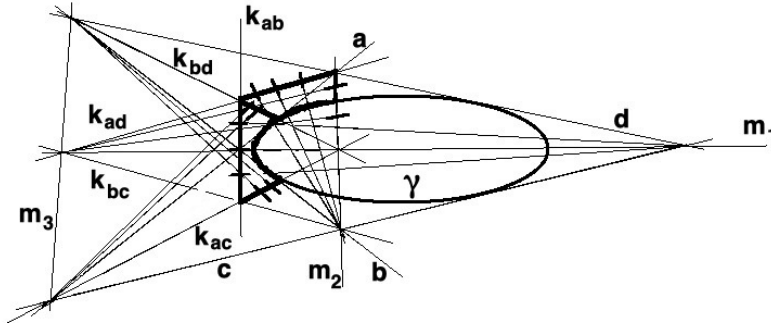

Figure 21: Two projective billiards (with boundaries marked in bold) with integral of minimal degree 12.

4.4 Semi-(pseudo-) Euclidean billiards with integrals of different degrees

Definition 4.7 A projective billiard in \mathbb{R}_{x_1, x_2}^2 with piecewise smooth boundary is called *semi-Euclidean (semi-pseudo-Euclidean)*, if the nonlinear part of the boundary, i.e., its complement to the union of straightline intervals contained there, is equipped with normal line field for the standard Euclidean metric $dx_1^2 + dx_2^2$ (respectively, for the standard pseudo-Euclidean metric $dx_1^2 - dx_2^2$).

Theorem 4.8 *A semi-Euclidean billiard is rationally 0-homogeneously integrable, if and only if the nonlinear part of its boundary is a finite union of confocal conical arcs and segments of some of the **admissible real lines** (listed below) for the corresponding confocal pencil of conics:*

- Case 1), pencil of confocal ellipses and hyperbolas:*
- the two symmetry axes of the ellipses, equipped with normal line field;

- the lines L_1, L_2 through the foci F_1, F_2 , orthogonal to the line F_1F_2 , each L_j is equipped with the field of lines through the other focus F_{2-j} .
The billiard has quadratic integral, if and only if its boundary contains no segments of lines $L_{1,2}$; otherwise the minimal degree of integral is four.

Case 2), pencil of confocal parabolas:

- the common axis of the parabolas;
- the line L through the focus that is orthogonal to the axis.

Both lines are equipped with the normal line field. The billiard has quadratic integral, if and only if its boundary contains no segments of the line L ; otherwise the minimal degree of integral is four.

Proof The other admissible lines from Definition 1.34 are not finite real lines. For example, in Case 1) the dual pencil of confocal conics consists of conics tangent to two given pairs of lines through the two isotropic points $[1 : \pm i : 0]$ at infinity. In this case the only real skew admissible lines are the lines L_1 and L_2 , and they are opposite as skew admissible lines: they correspond to two opposite intersection points of the above tangent lines, namely, the foci F_1 and F_2 . Similarly in Case 2) the only real skew admissible line is L . This together with Theorem 1.40 proves Theorem 4.8. \square

Example 4.9 Consider an ellipse and a line L_1 through its left focus F_1 that is orthogonal to the foci line. See Fig. 22, the left part. Consider the dashed domain bounded by the intersection segment of the line L_1 with the ellipse interior and the left elliptic arc; the latter arc is equipped with normal line field, and the segment with the field of lines through the other focus F_2 . This projective billiard admits a rational 0-homogeneous integral of minimal degree four. As the second focus F_2 tends to infinity so that the ellipse tends to a parabola with the focus $F = F_1$, the above billiard converges to a usual billiard (with normal line field) bounded by a segment of the line L through F orthogonal to the parabola axis and by a parabola arc. See the right part of Fig. 22. The latter parabolic billiard is known to have a polynomial integral of minimal degree four (and hence, a rational 0-homogeneous integral of the same degree). It was first discovered in [34].

Proposition 4.10 *The projective billiards with rational 0-homogeneous integral of minimal degrees 4 and 12 presented at Fig. 20 and 21 respectively are realized by semi-pseudo-Euclidean billiards in $(\mathbb{R}^2, dx_1^2 - dx_2^2)$.*

Proof Take the points $bd = b \cap d$ and $ac = a \cap c$ to be the isotropic points at infinity $[1 : \pm 1 : 0]$. \square

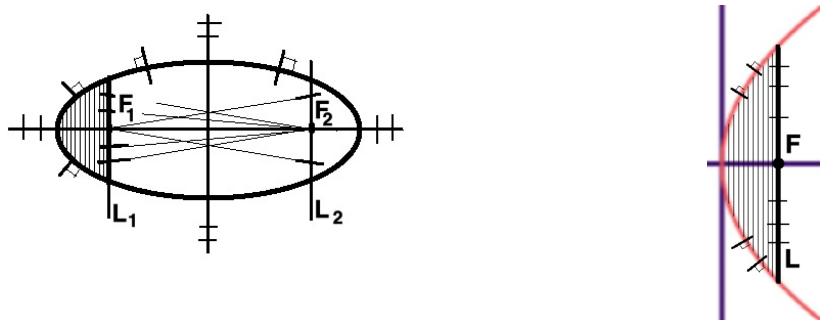

Figure 22: Billiards (dashed) with degree 4 integrals. On the left: the semi-Euclidean billiard bounded by a segment of the line L_1 and an elliptic arc. As the ellipse degenerates to a horizontal parabola, it tends to the Euclidean billiard on the right discovered in [34], with degree 4 polynomial integral.

References

- [1] Avila, A.; De Simoi, J.; Kaloshin, V. *An integrable deformation of an ellipse of small eccentricity is an ellipse*. *Ann. of Math. (2)* **184** (2016), no. 2, 527–558.
- [2] Amiran, E. *Caustics and evolutes for convex planar domains*. *J. Diff. Geometry*, **28** (1988), 345–357.
- [3] Bialy, M. *Convex billiards and a theorem by E. Hopf*. *Math. Z.*, **214**(1) (1993), 147–154.
- [4] Bialy, M. *On totally integrable magnetic billiards on constant curvature surface*. *Electron. Res. Announc. Math. Sci.* **19** (2012), 112–119.
- [5] Bialy, M. *Hopf rigidity for convex billiards on the hemisphere and hyperbolic plane*. *Discrete Contin. Dyn. Syst.* **33** (2013), No. 9, 3903–3913.
- [6] Bialy, M.; Mironov, A. *On fourth-degree polynomial integrals of the Birkhoff billiard*. *Proc. Steklov Inst. Math.*, **295** (2016), No.1, 27–32.
- [7] Bialy, M.; Mironov, A.E. *Algebraic non-integrability of magnetic billiards*. *J. Phys. A* **49** (2016), No. 45, 455101, 18 pp.

- [8] Bialy, M.; Mironov, A. *Angular billiard and algebraic Birkhoff conjecture*. Adv. in Math. **313** (2017), 102–126.
- [9] Bialy, M.; Mironov, A. *Algebraic Birkhoff conjecture for billiards on Sphere and Hyperbolic plane*. J. Geom. Phys., **115** (2017), 150–156.
- [10] Bialy, M.; Mironov, A.E. *Polynomial non-integrability of magnetic billiards on the sphere and the hyperbolic plane*. Russ. Math. Surveys, **74** (2018), 187–209.
- [11] Bialy, M.; Mironov, A.E. *A survey on polynomial in momenta integrals for billiard problems*, Phil. Trans. R. Soc. A., **336** (2018), Issue 2131, <https://doi.org/10.1098/rsta.2017.0418>
- [12] Bialy, M.; Mironov, A.E. *The Birkhoff-Poritsky conjecture for centrally-symmetric billiard tables*. Ann. of Math. (2) **196** (1) (2022), 389–413.
- [13] Bolotin, S.V. *Integrable Birkhoff billiards*. Mosc. Univ. Mech. Bull. **45:2** (1990), 10–13.
- [14] Bolotin, S.V. *Integrable billiards on surfaces of constant curvature*. Math. Notes **51** (1992), No. 1–2, 117–123.
- [15] Dragović, V.; Radnović, M. *Integrable billiards and quadrics*. Russian Math. Surveys **65** (2010), No. 2, 319–379.
- [16] Dragović, V.; Radnović, M. *Bicentennial of the great Poncelet theorem (1813–2013): current advances*. Bull. Amer. Math. Soc. (N.S.) **51** (2014), No. 3, 373–445.
- [17] Dragović, V.; Radnović, M. *Pseudo-integrable billiards and arithmetic dynamics*. J. Mod. Dyn. **8** (2014), No. 1, 109–132.
- [18] Dragović, V.; Radnović, M. *Periods of pseudo-integrable billiards*. Arnold Math. J. **1** (2015), No. 1, 69–73.
- [19] Dragović, V.; Radnović, M. *Pseudo-integrable billiards and double reflection nets*. Russian Math. Surveys **70** (2015), No. 1, 1–31.
- [20] Fierobe, C. *Projective and complex billiards, periodic orbits and Pfaffian systems*. PhD thesis, ENS de Lyon, 2021. Preprint <https://tel.archives-ouvertes.fr/tel-03267693>
- [21] Fierobe, C. *On projective billiards with open subsets of triangular orbits*. To appear in Israel J. of Math. Preprint <https://arxiv.org/abs/2005.02012>

- [22] Fierobe, C. *Examples of reflective projective billiards and outer ghost billiards*. Preprint <https://arxiv.org/abs/2002.09845>
- [23] Glutsyuk, A.; Shustin, E. *On polynomially integrable planar outer billiards and curves with symmetry property*. *Math. Annalen*, **372** (2018), 1481–1501.
- [24] Glutsyuk, A.A. *On two-dimensional polynomially integrable billiards on surfaces of constant curvature*. *Doklady Mathematics*, **98** (2018), No. 1, 382–385.
- [25] Glutsyuk, A.A. *On polynomially integrable Birkhoff billiards on surfaces of constant curvature*. *J. Eur. Math. Soc.* **23** (2021), 995–1049.
- [26] Glusyuk, A. *On infinitely many foliations by caustics in strictly convex non-closed billiards*. Preprint <https://arxiv.org/abs/2104.01362>
- [27] Glutsyuk, A. *On rationally integrable planar dual and projective billiards*. Preprint <https://arxiv.org/abs/2112.07056>
- [28] Kaloshin, V.; Sorrentino, A. *On local Birkhoff Conjecture for convex billiards*. *Ann. of Math.*, **188** (2018), No. 1, 315–380.
- [29] V. Kaloshin, A. Sorrentino. *On the integrability of Birkhoff billiards*. *Philos. Trans. Roy. Soc. A* **376** (2018), No. 2131, 20170419, 16 pp.
- [30] Kozlov, V.V.; Treshchev, D.V. *Billiards. A genetic introduction to the dynamics of systems with impacts*. Translated from Russian by J.R.Schulenberger. *Translations of Mathematical Monographs*, **89**, American Mathematical Society, Providence, RI, 1991.
- [31] Lazutkin, V.F. *The existence of caustics for a billiard problem in a convex domain*. *Math. USSR Izvestija* **7** (1973), 185–214.
- [32] Marco, J.-P. *Entropy of billiard maps and a dynamical version of the Birkhoff conjecture*. *J. Geom. Phys.*, **124** (2018), 413–420.
- [33] Poritsky, H. *The billiard ball problem on a table with a convex boundary – an illustrative dynamical problem*. *Ann. of Math. (2)* **51** (1950), 446–470.
- [34] Ramani, A.; Kalliterakis, A.; Grammaticos, B.; Dorizzi, B. *Integrable curvilinear billiards*. *Phys. Lett. A*, **115** (1986), No. 1–2, 25–28.
- [35] Tabachnikov, S. *Introducing projective billiards*. *Ergod. Th. Dynam. Sys.* **17** (1997), 957–976.

- [36] Tabachnikov, S. *On algebraically integrable outer billiards*. Pacific J. of Math. **235** (2008), No. 1, 101–104.
- [37] Treschev, D. *Billiard map and rigid rotation*. Phys. D., **255** (2013), 31–34.
- [38] Treschev, D. *On a Conjugacy Problem in Billiard Dynamics*. Proc. Steklov Inst. Math., **289** (2015), No. 1, 291–299.
- [39] Treschev, D. *A locally integrable multi-dimensional billiard system*. Discrete Contin. Dyn. Syst. **37** (2017), No. 10, 5271–5284.
- [40] Veselov, A. P. *Integrable systems with discrete time, and difference operators*. Funct. Anal. Appl. **22** (1988), No. 2, 83–93.
- [41] Veselov, A.P. *Confocal surfaces and integrable billiards on the sphere and in the Lobachevsky space*. J. Geom. Phys., **7** (1990), Issue 1, 81–107.
- [42] Wojtkowski, M.P. *Two applications of Jacobi fields to the billiard ball problem*. J. Differential Geom. **40** (1) (1994), 155–164.