



HAL
open science

On rationally integrable planar dual multibilliards and piecewise smooth projective billiards

Alexey Glutsyuk

► **To cite this version:**

Alexey Glutsyuk. On rationally integrable planar dual multibilliards and piecewise smooth projective billiards. *Nonlinearity*, 2024, 37 (6), pp.065002. 10.1088/1361-6544/ad3606 . ensl-03925877v2

HAL Id: ensl-03925877

<https://ens-lyon.hal.science/ensl-03925877v2>

Submitted on 24 Jan 2024 (v2), last revised 16 Nov 2024 (v3)

HAL is a multi-disciplinary open access archive for the deposit and dissemination of scientific research documents, whether they are published or not. The documents may come from teaching and research institutions in France or abroad, or from public or private research centers.

L'archive ouverte pluridisciplinaire **HAL**, est destinée au dépôt et à la diffusion de documents scientifiques de niveau recherche, publiés ou non, émanant des établissements d'enseignement et de recherche français ou étrangers, des laboratoires publics ou privés.

On rationally integrable planar dual multibilliards and piecewise smooth projective billiards

Alexey Glutsyuk^{*†‡§}

September 7, 2023

Abstract

The billiard flow in a planar domain Ω acts on the tangent bundle $T\mathbb{R}^2|_{\Omega}$ as geodesic flow with reflections from the boundary. It has the trivial first integral: squared modulus of the velocity. Bolotin's Conjecture, now a joint theorem of Bialy, Mironov and the author, deals with those billiards whose flow admits an additional integral that is polynomial in the velocity and whose restriction to the unit tangent bundle is non-constant. It states that 1) if the boundary of such a billiard is C^2 -smooth, nonlinear and connected, then it is a conic; 2) if it is piecewise C^2 -smooth and contains a nonlinear arc, then it consists of arcs of conics from a confocal pencil and segments of "admissible lines" for the pencil; 3) the minimal degree of the additional integral is either 2, or 4. In 1997 Sergei Tabachnikov introduced *projective billiards*: planar curves equipped with a transversal line field, which defines a reflection acting on oriented lines and the projective billiard flow. They are common generalization of billiards on surfaces of constant curvature, but in general may have no canonical conserved quantity. In a previous paper the author classified those C^4 -smooth connected nonlinear planar projective billiards whose flow admits a non-constant integral that is a rational 0-homogeneous function of the velocity (with coefficients depending on the position): these billiards are called *rationally 0-homogeneously integrable*. It was shown that: 1) the underlying curve is a conic; 2) the minimal degree of integral is equal to two, if the billiard is defined by a dual pencil of conics; 3) otherwise it can be arbitrary even number. In the present paper we classify *piecewise C^4 -smooth* rationally 0-homogeneously integrable projective billiards. Unexpectedly, we show that such a billiard associated to a dual pencil of conics may have integral of minimal degree 2, 4, or **12**. For the proof of main results we prove dual results for the so-called dual multibilliards introduced in the present paper.

Contents

1 Introduction

3

*CNRS, UMR 5669 (UMPA, ENS de Lyon), France. E-mail: aglutsyu@ens-lyon.fr

†HSE University, Moscow, Russia

‡Kharkevich Institute for Information Transmission Problems (IITP, RAS), Moscow

§Supported by part by RFBR grant 20-01-00420

1.1	Introduction, brief description of main results and plan of the paper	3
1.2	Previous results 1: classification of real and complex rationally integral dual billiards on one curve	10
1.3	Previous results 2: classification of rationally 0-homogeneously integrable projective billiards on one curve	12
1.4	Main results: classification of rationally integrable planar dual multibilliards with C^4 -smooth curves	13
1.5	Application: classification of rationally 0-homogeneously integrable piecewise C^4 -smooth non-polygonal projective billiards	20
1.6	Plan of proofs of main results	27
1.7	Historical remarks	29
2	Rationally integrable dual multibilliards. Proofs of Theorems 1.29, 1.30, 1.31, 1.35	30
2.1	Rational integrability of pencil type multibilliards	30
2.2	Foliation by level curves of rational integral. Proof of Theorems 1.29 and 1.31	34
2.3	Dual billiard structures at vertices. Birationality and types of involutions .	39
2.4	Pencil case. Proof of Theorem 1.30	46
2.5	Exotic multibilliards. Proof of Theorem 1.35	48
2.6	Real admissible vertices (lines) of (dual) pencils of conics. Proof of Propositions 1.28 and 1.45	52
3	Rationally 0-homogeneously integrable piecewise smooth projective billiards. Proof of Theorems 1.42, 1.43, 1.50	54
3.1	Duality and correspondence between integrals	55
3.2	Rationally 0-homogeneously integrable billiards on surfaces of constant curvature. Proof of Proposition 1.8	56
3.3	Case of dual pencil. Proof of Theorems 1.42, 1.43, 1.44	58
3.4	Exotic projective billiards. Proof of Theorem 1.50	59
4	Integrals of dual pencil type billiards: examples of degrees 4 and 12. Proof of Theorems 1.32, 1.46 and Lemma 1.47	61
4.1	Multibilliards of pencil type. Proof of Theorem 1.32	61
4.2	Dual pencil billiards. Proof of Theorem 1.46 and Lemma 1.47	64
4.3	Generic dual pencil billiards with integrals of degrees 4 and 12	66
4.4	Semi-(pseudo-) Euclidean billiards with integrals of different degrees	67
5	Acknowledgments	68

1 Introduction

1.1 Introduction, brief description of main results and plan of the paper

Consider a planar billiard $\Omega \subset \mathbb{R}^2$ bounded by a C^2 -smooth strictly convex closed curve. Recall that its *caustic* is a curve $S \subset \mathbb{R}^2$ such that each tangent line to S is reflected from the boundary $\partial\Omega$ to a line tangent to S . A billiard is *Birkhoff integrable*, if an inner neighborhood of its boundary is foliated by closed caustics, with boundary being a leaf of the foliation. This is the case in an elliptic billiard: confocal ellipses form a foliation by closed caustics of a domain adjacent to the boundary ellipse. The famous open Birkhoff Conjecture states that *the only integrable billiards are ellipses*. See its brief survey in Subsection 1.7.

The billiard flow in a domain Ω acts on the tangent bundle $T\mathbb{R}^2|_{\Omega}$ as follows. A point (Q, v) , $Q \in \Omega$, $v \in T_Q\mathbb{R}^2$, moves along a trajectory of geodesic flow (v remains constant as a vector in \mathbb{R}^2 , and Q moves with constant speed v), until Q hits the boundary $\partial\Omega$. Then v is reflected from the boundary to the new vector $v^* \in T_Q\mathbb{R}^2$ according to the standard reflection law: the angle of incidence is equal to the angle of reflection, and $\|v^*\| = \|v\|$. Afterwards the new point (Q, v^*) moves by the geodesic flow etc. The billiard flow has trivial first integral $\|v\|^2$. It is a well-known folklore fact that Birkhoff integrability of a strictly convex bounded planar billiard is equivalent to the existence of a non-trivial first integral of the billiard flow independent with $\|v\|^2$ on a neighborhood of the unit tangent bundle to $\partial\Omega$ in $T\mathbb{R}^2|_{\overline{\Omega}}$.

A planar billiard is called *polynomially integrable*, if its flow admits a first integral that is polynomial in the velocity (with coefficients depending on Q) whose restriction to the unit tangent bundle is non-constant. Sergei Bolotin suggested the following polynomial version of the Birkhoff Conjecture, which is now a theorem: a joint result of Mikhail Bialy, Andrei Mironov and the author, see [9, 10, 27, 28]. *A planar billiard with piecewise C^2 -smooth boundary is polynomially integrable, if and only if one of the following statements holds:*

1) *if the boundary $\partial\Omega$ is C^2 -smooth, connected and nonlinear, then it is a conic (or a connected component of a conic);*

2) *if $\partial\Omega$ is piecewise C^2 -smooth, then it is a union of arcs of conics from a confocal pencil and maybe segments of so-called admissible lines for the pencil of conics in question. If a billiard has one of the above types 1) or 2), then the billiard flow has a nontrivial quadratic integral, unless the pencil in question consists of confocal parabolas and $\partial\Omega$ contains a segment of the line through the focus that is orthogonal to the common axis of the parabolas; in the latter case the minimal degree of integral is equal to four.*

The above parabolic example with degree four integral was discovered by A. Ramani, A. Kalliterakis, B. Grammaticos, B. Dorizzi [38].

The goal of the present paper is to prove analogous results for planar projective billiards introduced by Sergei Tabachnikov in 1997 [39], see the following definition.

Definition 1.1 [39] *A projective billiard is a smooth planar curve $C \subset \mathbb{R}^2$ equipped with a transversal line field \mathcal{N} . For every $Q \in C$ the projective billiard reflection involution at Q acts on the space of lines through Q as the affine involution $\mathbb{R}^2 \rightarrow \mathbb{R}^2$ that fixes the points*

of the tangent line to C at Q , preserves the line $\mathcal{N}(Q)$ and acts on $\mathcal{N}(Q)$ as the central symmetry with respect to the point¹ Q . In the case, when C is a strictly convex closed curve, the *projective billiard map* acts on the *phase cylinder*: the space of oriented lines intersecting C . It sends an oriented line to its image under the above reflection involution at its last point of intersection with C in the sense of orientation. See Fig. 1.

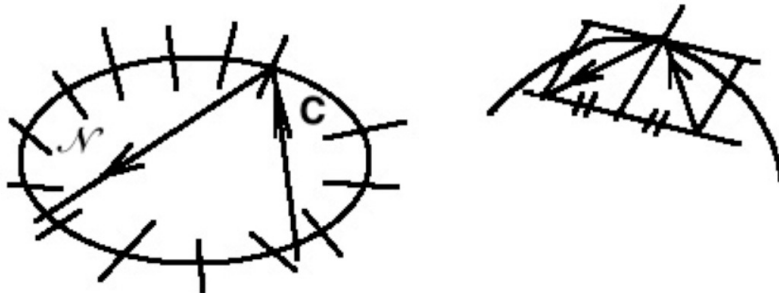

Figure 1: The projective billiard reflection.

Example 1.2 A usual Euclidean planar billiard is a projective billiard with transversal line field being the normal line field. Each billiard in a complete Riemannian surface Σ of non-zero constant curvature (i.e., in sphere S^2 and in hyperbolic plane \mathbb{H}^2) also can be seen as a projective billiard, see [39]. Namely, consider $\Sigma = S^2$ as the unit sphere in the Euclidean space \mathbb{R}^3 , and $\Sigma = \mathbb{H}^2$ as the semi-pseudo-sphere $\{x_1^2 + x_2^2 - x_3^2 = -1, x_3 > 0\}$ in the Minkowski space \mathbb{R}^3 equipped with the form $dx_1^2 + dx_2^2 - dx_3^2$. The billiard in a domain $\Omega \subset \Sigma_+ := \Sigma \cap \{x_3 > 0\}$ is defined by reflection of geodesics from its boundary. The tautological projection $\pi : \mathbb{R}^3 \setminus \{0\} \rightarrow \mathbb{RP}^2$ sends Ω diffeomorphically onto a domain in the affine chart $\{x_3 = 1\}$. It sends billiard orbits in Ω to orbits of the projective billiard on $C = \pi(\partial\Omega)$ with the transversal line field \mathcal{N} on C being the image of the normal line field to $\partial\Omega$ under the differential $d\pi$.

The notion of caustic (integrability) of a projective billiard repeats the above similar notions for the usual billiards. **Tabachnikov Conjecture** states that *if a projective billiard is integrable, then the billiard boundary and the caustics are conics, whose dual conics form a pencil*. It was stated in print in equivalent dual form (for dual billiards) in [40].

The billiard flow of a projective billiard is defined analogously to the usual billiard flow, see [39, pp. 958, 960]. But now as Q hits the boundary (the underlying curve of the projective billiard), the initial velocity $v \in T_Q\mathbb{R}^2$ is reflected to the new velocity v^* by the projective billiard reflection. See Fig. 2. A projective billiard on a strictly convex closed

¹In other words, two lines a, b through Q are permuted by reflection at Q , if and only if the quadruple of lines $T_Q C, \mathcal{N}(Q), a, b$ is harmonic: there exists a projective involution of the space \mathbb{RP}^1 of lines through Q that fixes $T_Q C, \mathcal{N}(Q)$ and permutes a, b .

planar curve is Birkhoff integrable, if and only if its flow admits a smooth first integral without critical points on a neighborhood of the unit tangent bundle to $\partial\Omega$ in $T\mathbb{R}^2|_{\overline{\Omega}}$ that is a 0-homogeneous function of the velocity. The proof of this equivalence statement repeats the proof of the similar above-mentioned folkore fact for the usual billiards.

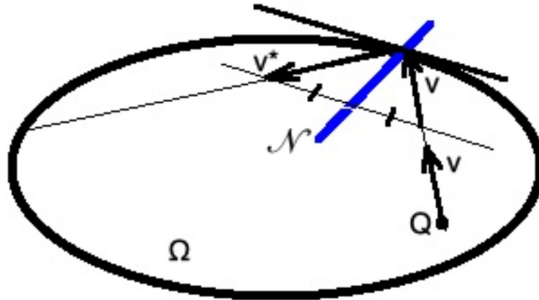

Figure 2: Projective billiard flow

Remark 1.3 Each Euclidean planar billiard flow always has the trivial first integral $\|v\|^2$. But this is not true for a generic projective billiard.

Problem 1.4 *Classify those projective billiards whose flow admits at least one nonconstant first integral that is polynomial in the velocity.*

In the present paper we classify rationally 0-homogeneously integrable² non-polygonal piecewise C^4 -smooth projective billiards, see the following definition, up to *projective equivalence*: two projective billiards are equivalent, if one obtained from the other by projective transformation.

Definition 1.5 A projective billiard is *rationally 0-homogeneously integrable*, if its flow admits a non-constant first integral that depends on the velocity as a rational 0-homogeneous function, of degree uniformly bounded by some number n : a function $\Psi(Q, v) = \frac{P(v)}{T(v)}$, where P and T are homogeneous polynomials in v of degree no greater than n with coefficients depending on the position of the point Q . The maximal degree of the latter rational function through all Q is called the *degree* of the rational integral.

Example 1.6 Let $C, \Gamma \subset \mathbb{R}_{x_1, x_2}^2$ be distinct regular conics. The punctured conic $C \setminus \Gamma$ can be equipped with a unique projective billiard structure (transversal line field \mathcal{N}) so that the

²The notion of polynomially integrable projective billiard, see Problem 1.4, is invariant under affine transformations. But a priori, it is not invariant under projective transformations, since in general, a projective transformation sending one projective billiard to another one does not conjugate the corresponding projective billiard flows. On the other hand, the notion of rationally 0-homogeneously integrable projective billiard is invariant under projective transformations. The pullback of a rational 0-homogeneous integral of a projective billiard under a projective transformation is an integral of its preimage.

complexified conic Γ is its caustic. This means that for every $x \in C \setminus \Gamma$ the two complex tangent lines to Γ through x and the lines $T_x C$, $\mathcal{N}(x)$ form a harmonic quadruple. Thus constructed projective billiard on C will be called a *dual pencil type projective billiard on a punctured conic* C . It is well-known that then every conic from the dual pencil containing C and Γ is a caustic in the above sense. This follows from Desargues theorem, see [3] and Example 1.11 below, by duality. See also [17] and [23, subsection 2.3]. The corresponding projective billiard flow has a quadratic rational 0-homogeneous integral. Namely, let $B, A \in GL_3(\mathbb{R})$ be such that in homogeneous coordinates $[x_1 : x_2 : x_3]$ in the ambient projective plane $\mathbb{R}P^2 \supset \mathbb{R}_{x_1, x_2}^2 = \{x_3 = 1\}$ one has

$$C = \{ \langle B^{-1}x, x \rangle = 0 \}, \Gamma = \{ \langle A^{-1}x, x \rangle = 0 \}, \langle x, y \rangle := \sum_{j=1}^3 x_j y_j.$$

The conics forming the dual pencil containing C and Γ are the conics

$$\mathcal{C}_\lambda := \{ \langle (B - \lambda A)^{-1}x, x \rangle = 0 \}, \lambda \in \mathbb{C}.$$

They are caustics in the above sense. For every $(x_1, x_2) \in \mathbb{R}^2$ and $(v_1, v_2) \in T_{(x_1, x_2)}\mathbb{R}^2$ set

$$r := (x_1, x_2, 1), v := (v_1, v_2, 0),$$

$$\mathcal{M} = \mathcal{M}(r, v) := [r, v] = (-v_2, v_1, \Delta) \subset \mathbb{R}^3, \quad \Delta := x_1 v_2 - x_2 v_1. \quad (1.1)$$

Then the ratio

$$\Psi(x, v) := \frac{\langle B\mathcal{M}, \mathcal{M} \rangle}{\langle A\mathcal{M}, \mathcal{M} \rangle} \quad (1.2)$$

is a first integral of the projective billiard flow. This can be proved by using Bolotin's argument [16, p.22] and will be explained below, in Remark 1.12, via duality.

Remark 1.7 A degree n rational 0-homogeneous integral of a projective billiard is always a degree n rational 0-homogeneous function in the moment $\mathcal{M} = (-v_2, v_1, \Delta)$ with constant coefficients. See analogous statement for polynomial integrals of planar billiards earlier proved by Bolotin in [16], and the general statement for projective billiards in [30, proposition 1.23, statement 1)].

In the previous paper [30, theorem 1.26] the author classified rationally 0-homogeneously integrable projective billiard structures on (germs of) nonlinear C^4 -smooth connected planar curves. It was shown there that

- the underlying curve is always a conic;
- besides Example 1.6 of dual pencil type projective billiard, which has a quadratic integral, there are infinitely many other rationally 0-homogeneously integrable projective billiard structures on a conic, called *exotic structures*, with minimal degree of integral being arbitrary even number greater than 3. These results of [30] are recalled in Subsection 1.3.

The main results of the present paper (Theorems 1.42, 1.43, 1.50 stated in Subsection 1.5) yield the classification of rationally 0-homogeneously integrable projective billiards

with piecewise C^4 -smooth boundary that contains a nonlinear arc and maybe also straight-line segments. They show that a piecewise C^4 -smooth projective billiard is rationally 0-homogeneously integrable, if and only if the following statements hold:

1) The nonlinear part of the boundary lies either in one conic (equipped with either a dual pencil, or exotic projective billiard structure), or in a union of several conics lying the same dual pencil, with projective billiard structures defined by the same pencil.

2) If the projective billiard structure on the conical part of the boundary is defined by a dual pencil, then the projective billiard is of dual pencil type. This means that on each conic it is defined by the same dual pencil, and the collection of lines containing straightline segments of the boundary satisfies certain conditions. In particular, they belong to the list of so-called *admissible lines for the dual pencil* equipped with appropriate projective billiard structures defined by the pencil.

3) If the conical part of the boundary lies in one conic equipped with an exotic projective billiard structure, then the ambient lines of boundary straightline segments (if any) belong to an explicit finite list of lines called *admissible for the exotic structure* in question.

In the dual pencil case the projective billiard structure on each admissible line is given by a line field that either is central (i.e., its lines pass through a given point), or consists of lines tangent to a given conic of the dual pencil. In the exotic case each admissible line is equipped with appropriate central line field.

Theorem 1.44 gives a formula for the minimal degree of integral of a dual pencil type billiard. It yields the following unexpected result: for a dual pencil type projective billiard defined by a generic pencil and containing straightline segments of appropriate collection of admissible lines, the minimal degree of integral is equal to **12**.

Theorem 1.46 gives a formula for degree 12 integral in terms of just the dual pencil: it is an integral of every dual pencil type projective billiard defined by the given pencil.

We also prove the following new result on usual billiards on constant curvature surfaces.

Proposition 1.8 *A piecewise C^2 -smooth non-polygonal billiard on a surface of constant curvature is rationally 0-homogeneously integrable, if and only if it is polynomially integrable. In this case the minimal degree of its non-trivial rational 0-homogeneous integral is equal to either 2, or 4: to the minimal degree of a non-trivial nonlinear polynomial integral. Rational integral of minimal degree can be chosen to be $\frac{I(x,v)}{\|v\|^{2n}}$, where $I(x,v)$ is a nontrivial homogeneous polynomial in v integral of degree $2n$, $n \in \{1, 2\}$.*

Thus, *rationally 0-homogeneously integrable projective billiards of dual pencil type with integrals of degree 12* presented and classified in this paper *form an essentially new class of rationally integrable projective billiards of dual pencil type, not covered by the known list of polynomially integrable billiards on surfaces of constant curvature.*

For the proof of main results, we state (in Subsection 1.4) and prove their projective dual versions giving classification of the so-called rationally integrable dual multibilliards defined below. Namely, consider the plane \mathbb{R}_{x_1, x_2}^2 as the affine chart $\{x_3 = 1\}$ in $\mathbb{RP}_{[x_1: x_2: x_3]}^2$. Consider the correspondence sending a two-dimensional vector subspace in the Euclidean space $\mathbb{R}_{x_1, x_2, x_3}^3$ to its orthogonal complement, which is a one-dimensional subspace. The

induced correspondence $\mathbb{RP}^{2*} \rightarrow \mathbb{RP}^2$ sending a projective line in \mathbb{RP}^2 (projectivized two-dimensional subspace) to a point in \mathbb{RP}^2 (the projectivized orthogonal) is a projective duality called the *orthogonal polarity*. For every smooth planar curve C its dual $\gamma = C^*$ is the family of points dual to the projective lines tangent to C . For every $Q \in C$ let L_Q denote the projective line tangent to C at Q . The dual to the space \mathbb{RP}^1 of lines through Q is the projective line L_P tangent to γ at $P = L_Q^*$. The projective billiard reflection acting on \mathbb{RP}^1 is conjugated to a projective involution $\sigma_P : L_P \rightarrow L_P$. This implies the following well-known fact observed by Tabachnikov: the dual to a projective billiard on a curve C containing no straightline segments is the dual billiard introduced by Tabachnikov in [40, p. 103], see the following definition.

Definition 1.9 [30, definitions 1.6, 1.17] A *real (complex) dual billiard* is a smooth (holomorphic) curve $\gamma \subset \mathbb{RP}^2(\mathbb{CP}^2)$ where for each point $P \in \gamma$ the real (complex) projective line L_P tangent to γ at P is equipped with a projective involution $\sigma_P : L_P \rightarrow L_P$ fixing P ; the involution family (called *dual billiard structure*) is parametrized by tangency points P .

It is known, see [30, proposition 1.24], that the projective dual to a rationally 0-homogeneously integrable projective billiard on a nonlinear curve is a rationally integrable dual billiard, see the next definition.

Definition 1.10 [30, definition 1.12] A dual billiard is called *rationally integrable*, if there exists a non-constant rational function R on the plane (called *integral*) whose restriction to each line tangent to the underlying curve is invariant under the corresponding involution:

$$(R \circ \sigma_P)|_{L_P} = R|_{L_P}. \quad (1.3)$$

The dual to a dual pencil type projective structure on a conic is a pencil type dual billiard, see the following example.

Example 1.11 [30, example 1.14] Consider a conic γ and a pencil of conics containing γ : the family of conics either passing through given four distinct complex points of γ , or passing through given three distinct points and tangent to each other at one of them, etc. Their common points are called the *base points* of the pencil. Then for every non-base point $P \in \gamma$ there exists a projective involution $\sigma_P : L_P \rightarrow L_P$ fixing P and permuting the intersection points of the tangent line L_P to γ with each conic of the pencil (Desargues theorem, see [3]). The dual billiard on the curve γ punctured at the base points given by the involution family σ_P is said to be of *pencil type*. It is rationally integrable with a quadratic integral, which is the ratio of two quadratic polynomials vanishing on two arbitrary given conics of the pencil (Tabachnikov's observation, see [30, example 1.14]).

Remark 1.12 For every nonzero vector $v \in T_{(x_1, x_2)}\mathbb{R}^2$ the duality sends the projective line tangent to v to the point $[\mathcal{M}_1 : \mathcal{M}_2 : \mathcal{M}_3] \in \mathbb{RP}^2$, where \mathcal{M} is the moment vector, see (1.1). Thus, $[\mathcal{M}_1 : \mathcal{M}_2 : \mathcal{M}_3]$ can be treated as natural homogeneous coordinates on the projective plane containing the dual billiard to a given projective billiard on a curve

C. This implies that *each rational integral of the dual billiard written as a rational 0-homogeneous function of $\mathcal{M} = [r, v]$ is a rational 0-homogeneous integral of the projective billiard flow*, see [30, proposition 1.24]. A version of converse statement for polynomially integrable planar billiards was previously proved by Bialy and Mironov [9, theorem 3]. A more general statement for multibilliards with its converse will be proved below, in Subsection 3.1 (Proposition 3.3). It is well-known that the duality given by the orthogonal polarity transforms each conic $\gamma = \{ \langle A\mathcal{M}, \mathcal{M} \rangle = 0 \}$, $A \in GL_3(\mathbb{C})$, to the conic given by the inverse matrix, $C = \{ \langle A^{-1}x, x \rangle = 0 \}$. This together with the above statement and the statement of Example 1.11 implies that the function (1.2) is indeed an integral of the dual pencil type projective billiard in Example 1.6.

Example 1.13 If a dual billiard on a nonlinear curve has a polynomial integral, then it is an *outer billiard*: the projective involution of each tangent line is its central symmetry with respect to the tangency point (see [30, example 1.13]). The dual billiard to a usual planar billiard is Bialy–Mironov angular billiard [9].

As shown in [30, theorem 1.16], a dual billiard on a nonlinear C^4 -smooth germ γ of planar curve billiard is rationally integrable, if and only if γ is a conic, and the dual billiard structure either is of pencil type, or belongs to an explicit infinite list of rationally integrable dual billiards on conic given in loc. cit. These results are recalled below, in Subsection 1.2.

Let the underlying curve of a projective billiard contain a segment I of a line q . The duality sends q to a point $Q \in \mathbb{RP}^2$, and the family of points in I is sent to an open subset in the space \mathbb{RP}^1 of lines through Q . For every point $r \in I$ the duality conjugates the projective billiard reflection at r acting on the space \mathbb{RP}^1 of lines through r to a projective involution of the dual line $\ell = r^*$. Thus, the projective billiard structure on I is transformed by duality to a dual billiard structure at the point Q , and *the dual to a piecewise smooth projective billiard is a dual multibilliard*, see the following two definitions.

Definition 1.14 A *real (complex) dual billiard structure* at a point $Q \in \mathbb{RP}^2(\mathbb{CP}^2)$ is a family of projective involutions $\sigma_{Q,\ell} : \ell \rightarrow \ell$ acting on real (complex) projective lines ℓ through Q that fix Q ; $\sigma_{Q,\ell}$ are defined on an open subset $U \subset \mathbb{RP}^1(\mathbb{CP}^1)$ of the space of lines through Q . No regularity of the family $\sigma_{Q,\ell}$ is assumed.

Definition 1.15 A *real (complex) dual multibilliard* is a (may be infinite) collection of smooth (holomorphic) nonlinear connected curves γ_j and points Q_s in $\mathbb{RP}^2(\mathbb{CP}^2)$ (called *vertices*), where each curve γ_j and each point Q_s are equipped with a dual billiard structure. (A priori a curve (vertex) may appear in a multibilliard several times as the same curve (point) equipped with different dual billiard structures.)

We show that the dual to a rationally 0-homogeneously integrable piecewise smooth projective billiard is a rationally integrable dual multibilliard, see the following definition.

Definition 1.16 A dual multibilliard is *rationally integrable*, if there exists a non-constant rational function on $\mathbb{RP}^2(\mathbb{CP}^2)$ whose restriction to each tangent line to every curve γ_j is in-

variant under the corresponding involution, and the same statement holds for its restriction to each line ℓ through any vertex Q , where the corresponding involution $\sigma_{Q,\ell}$ is defined.

The main results on classification of rationally integrable real and complex dual multi-billiards (not reduced to just one curve without vertices) are given by Theorems 1.29, 1.30 and 1.35 in Subsection 1.4. In particular we show that in every rationally integrable multi-billiard the dual billiard structure at each vertex is either a global projective involution of the ambient projective plane, or a birational involution of de Jonquières type whose fixed point locus is a conic. Theorem 1.31 shows that the so-called pencil type dual multibilliards may have rational integrals of degrees 2, 4 or 12. Theorem 1.32 presents an explicit formula for degree 12 integral. The main results on classification of rationally 0-homogeneously integrable piecewise C^4 -smooth projective billiards presented in Subsection 1.5 will be deduced from the above-mentioned results on multibilliards via projective duality arguments.

Plan of proof of main results is presented in Subsection 1.6. A historical survey is given in Subsection 1.7. The main results are proved in Sections 2 (for multibilliards) and 3 (for projective billiards). In Section 4 we prove formulas for degree 12 integrals (Theorems 1.32, 1.46 and Lemma 1.47) and present examples of projective billiards with integrals of degrees 4 and 12.

1.2 Previous results 1: classification of real and complex rationally integral dual billiards on one curve

Theorem 1.17 [30, theorem 1.16] *Let $\gamma \subset \mathbb{R}^2 \subset \mathbb{RP}^2$ be a C^4 -smooth connected nonlinear (germ of) curve equipped with a rationally integrable dual billiard structure. Then γ is a conic, and the dual billiard structure has one of the following types (up to real projective transformation $\mathbb{RP}^2 \rightarrow \mathbb{RP}^2$):*

- 1) *A pencil type dual billiard, defined by a real pencil of conics; it has a quadratic integral.*
- 2) *An **exotic** dual billiard. Namely, there exists an affine chart $\mathbb{R}_{z,w}^2 \subset \mathbb{RP}^2$ in which $\gamma = \{w = z^2\}$ and such that for every $P = (z_0, w_0) \in \gamma$ the involution $\sigma_P : L_P \rightarrow L_P$ is given by one of the following formulas:*

a) *In the coordinate*

$$\zeta := \frac{z}{z_0}$$

$$\sigma_P : \zeta \mapsto \eta_\rho(\zeta) := \frac{(\rho - 1)\zeta - (\rho - 2)}{\rho\zeta - (\rho - 1)},$$

$$\rho = 2 - \frac{2}{2N + 1} \text{ (type 2a1)}, \quad \text{or} \quad \rho = 2 - \frac{1}{N + 1} \text{ (type 2a2)}, \quad N \in \mathbb{N}. \quad (1.4)$$

b) *In the coordinate*

$$u := z - z_0$$

$$\sigma_P : u \mapsto -\frac{u}{1 + f(z_0)u}, \quad (1.5)$$

$$f = f_{b1}(z) := \frac{5z - 3}{2z(z - 1)} \text{ (type 2b1)}, \quad \text{or} \quad f = f_{b2}(z) := \frac{3z}{z^2 + 1} \text{ (type 2b2)}. \quad (1.6)$$

c) In the above coordinate u the involution σ_P takes the form (1.5) with

$$f = f_{c1}(z) := \frac{4z^2}{z^3 - 1} \text{ (type 2c1)}, \text{ or } f = f_{c2}(z) := \frac{8z - 4}{3z(z - 1)} \text{ (type 2c2)}. \quad (1.7)$$

d) In the above coordinate u the involution σ_P takes the form (1.5) with

$$f = f_d(z) = \frac{4}{3z} + \frac{1}{z - 1} = \frac{7z - 4}{3z(z - 1)} \text{ (type 2d)}. \quad (1.8)$$

Addendum to Theorem 1.17. Every dual billiard structure on γ of type 2a) has a rational first integral $R(z, w)$ of the form

$$R(z, w) = \frac{(w - z^2)^{2N+1}}{\prod_{j=1}^N (w - c_j z^2)^2}, \quad c_j = -\frac{4j(2N + 1 - j)}{(2N + 1 - 2j)^2}, \text{ for } \rho = 2 - \frac{2}{2N + 1}; \quad (1.9)$$

$$R(z, w) = \frac{(w - z^2)^{N+1}}{z \prod_{j=1}^N (w - c_j z^2)}, \quad c_j = -\frac{j(2N + 2 - j)}{(N + 1 - j)^2}, \text{ for } \rho = 2 - \frac{1}{N + 1}. \quad (1.10)$$

The dual billiards of types 2b1) and 2b2) have respectively the integrals

$$R_{b1}(z, w) = \frac{(w - z^2)^2}{(w + 3z^2)(z - 1)(z - w)}, \quad (1.11)$$

$$R_{b2}(z, w) = \frac{(w - z^2)^2}{(z^2 + w^2 + w + 1)(z^2 + 1)}. \quad (1.12)$$

The dual billiards of types 2c1), 2c2) have respectively the integrals

$$R_{c1}(z, w) = \frac{(w - z^2)^3}{(1 + w^3 - 2zw)^2}, \quad (1.13)$$

$$R_{c2}(z, w) = \frac{(w - z^2)^3}{(8z^3 - 8z^2w - 8z^2 - w^2 - w + 10zw)^2}. \quad (1.14)$$

The dual billiard of type 2d) has the integral

$$R_d(z, w) = \frac{(w - z^2)^3}{(w + 8z^2)(z - 1)(w + 8z^2 + 4w^2 + 5wz^2 - 14zw - 4z^3)}. \quad (1.15)$$

Theorem 1.18 [30, theorem 1.18 and its addendum]. Every regular (germ of) connected holomorphic curve in \mathbb{CP}^2 (different from a straight line) equipped with a rationally integrable complex dual billiard structure is a conic. Up to projective transformation $\mathbb{CP}^2 \rightarrow \mathbb{CP}^2$, the corresponding dual billiard structure has one of the types 1) (now defined by a complex pencil of conics), 2a), 2b1), 2c1), 2d) listed in Theorem 1.17, with a rational integral as in its addendum. The billiards of types 2b1), 2b2), see (1.6), are complex-projectively equivalent, and so are billiards 2c1), 2c2).

1.3 Previous results 2: classification of rationally 0-homogeneously integrable projective billiards on one curve

The notion of rationally 0-homogeneously integrable projective billiard also makes sense for a projective billiard structure on an arc of planar curve C (or a germ of curve), with projective billiard flow defined in a (germ of) domain adjacent to C .

Remark 1.19 The property of rational 0-homogeneous integrability of a projective billiard on a curve C is independent on the side from C on which the billiard domain is chosen: an integral for one side is automatically an integral for the other side. See [30, proposition 1.23, statement 2)].

Theorem 1.20 [30, theorem 1.26] *Let $C \subset \mathbb{R}_{x_1, x_2}^2$ be a nonlinear C^4 -smooth germ of curve equipped with a transversal line field \mathcal{N} . Let the corresponding germ of projective billiard be 0-homogeneously rationally integrable. Then C is a conic; the line field \mathcal{N} extends to a global analytic transversal line field on all of C punctured in at most four points; the corresponding projective billiard has one of the following types up to projective equivalence.*

1) *A dual pencil type projective billiard.*

2) *An **exotic** projective billiard. Namely, $C = \{x_2 = x_1^2\} \subset \mathbb{R}_{x_1, x_2}^2 \subset \mathbb{RP}^2$, and the line field \mathcal{N} is directed by one of the following vector fields at points of the conic C :*

$$2a) \quad (\dot{x}_1, \dot{x}_2) = (\rho, 2(\rho - 2)x_1),$$

$$\rho = 2 - \frac{2}{2N+1} \text{ (case 2a1), or } \rho = 2 - \frac{1}{N+1} \text{ (case 2a2), } N \in \mathbb{N},$$

the vector field 2a) has quadratic first integral $\mathcal{Q}_\rho(x_1, x_2) := \rho x_2 - (\rho - 2)x_1^2$.

$$2b1) \quad (\dot{x}_1, \dot{x}_2) = (5x_1 + 3, 2(x_2 - x_1)), \quad 2b2) \quad (\dot{x}_1, \dot{x}_2) = (3x_1, 2x_2 - 4),$$

$$2c1) \quad (\dot{x}_1, \dot{x}_2) = (x_2, x_1 x_2 - 1), \quad 2c2) \quad (\dot{x}_1, \dot{x}_2) = (2x_1 + 1, x_2 - x_1).$$

$$2d) \quad (\dot{x}_1, \dot{x}_2) = (7x_1 + 4, 2x_2 - 4x_1).$$

Addendum to Theorem 1.20. *The projective billiards from Theorem 1.20 have the following 0-homogeneous rational integrals:*

Case 1): A ratio of two homogeneous quadratic polynomials in (v_1, v_2, Δ) ,

$$\Delta := x_1 v_2 - x_2 v_1.$$

Case 2a1), $\rho = 2 - \frac{2}{2N+1}$:

$$\Psi_{2a1}(x_1, x_2, v_1, v_2) := \frac{(4v_1\Delta - v_2^2)^{2N+1}}{v_1^2 \prod_{j=1}^N (4v_1\Delta - c_j v_2^2)^2}. \quad (1.16)$$

Case 2a2), $\rho = 2 - \frac{1}{N+1}$:

$$\Psi_{2a2}(x_1, x_2, v_1, v_2) = \frac{(4v_1\Delta - v_2^2)^{N+1}}{v_1 v_2 \prod_{j=1}^N (4v_1\Delta - c_j v_2^2)}. \quad (1.17)$$

The c_j in (1.16), (1.17) are the same, as in (1.9) and (1.10) respectively.

Case 2b1):

$$\Psi_{2b1}(x_1, x_2, v_1, v_2) = \frac{(4v_1\Delta - v_2^2)^2}{(4v_1\Delta + 3v_2^2)(2v_1 + v_2)(2\Delta + v_2)}. \quad (1.18)$$

Case 2b2):

$$\Psi_{2b2}(x_1, x_2, v_1, v_2) = \frac{(4v_1\Delta - v_2^2)^2}{(v_2^2 + 4\Delta^2 + 4v_1\Delta + 4v_1^2)(v_2^2 + 4v_1^2)}. \quad (1.19)$$

$$\text{Case 2c1):} \quad \Psi_{2c1}(x_1, x_2, v_1, v_2) = \frac{(4v_1\Delta - v_2^2)^3}{(v_1^3 + \Delta^3 + v_1v_2\Delta)^2}. \quad (1.20)$$

Case 2c2):

$$\Psi_{2c2}(x_1, x_2, v_1, v_2) = \frac{(4v_1\Delta - v_2^2)^3}{(v_2^3 + 2v_2^2v_1 + (v_1^2 + 2v_2^2 + 5v_1v_2)\Delta + v_1\Delta^2)^2}. \quad (1.21)$$

Case 2d): $\Psi_{2d}(x_1, x_2, v_1, v_2)$

$$= \frac{(4v_1\Delta - v_2^2)^3}{(v_1\Delta + 2v_2^2)(2v_1 + v_2)(8v_1v_2^2 + 2v_2^3 + (4v_1^2 + 5v_2^2 + 28v_1v_2)\Delta + 16v_1\Delta^2)}. \quad (1.22)$$

1.4 Main results: classification of rationally integrable planar dual multi-billiards with C^4 -smooth curves

Each curve of a rationally integrable dual multibilliard is a conic, being itself an integrable dual billiard, see Theorem 1.17. The first theorems on classification of rationally integrable dual multibilliards presented below deal with those multibilliards whose curves are conics lying in one pencil, equipped with dual billiard structure defined by the same pencil. In particular, they state that the vertices should be admissible for the pencil. To define admissible vertices, let us first introduce the three following definitions.

Definition 1.21 A *projective angular symmetry* centered at a point $A \in \mathbb{CP}^2$ is a non-trivial projective involution $\sigma_A : \mathbb{CP}^2 \rightarrow \mathbb{CP}^2$ fixing A and each line through A . It is known to have a fixed point line $\Lambda \subset \mathbb{CP}^2$ disjoint from A . Its restrictions to lines through A define a dual billiard structure at A .

Example 1.22 Let now $A \in \mathbb{CP}^2$ and let $\mathcal{S} \subset \mathbb{CP}^2$ be a (may be singular) conic disjoint from A . There exists a projective angular symmetry centered at A and permuting the intersection points with \mathcal{S} of each line through A , called *\mathcal{S} -angular symmetry*, see [28, definition 2.4].

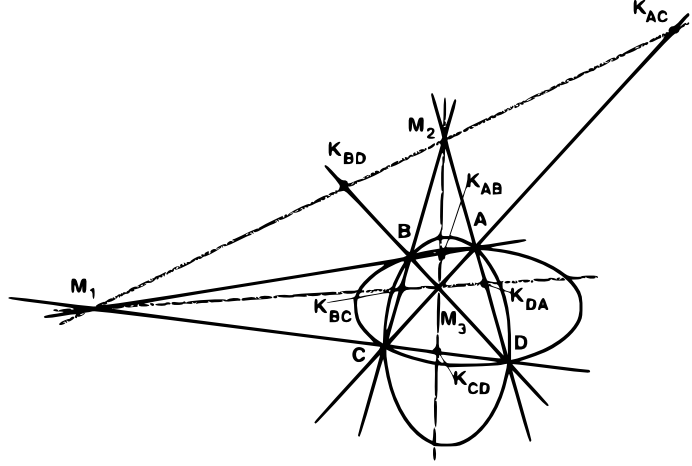

Figure 3: Case a)

Definition 1.23 Let now $A \in \mathbb{CP}^2$, $\mathcal{S} \subset \mathbb{CP}^2$ be a regular conic through A , and L_A the projective tangent line to \mathcal{S} at A . The *degenerate \mathcal{S} -angular symmetry* centered at A is the involution $\sigma_A = \sigma_A^{\mathcal{S}}$ acting on the complement $\mathbb{CP}^2 \setminus (L_A \setminus \{A\})$ that fixes A , fixes each line $\ell \neq L_A$ through A and whose restriction to ℓ is the projective involution fixing A and the other point of the intersection $\ell \cap \mathcal{S}$. It is known to be a birational map³ $\mathbb{CP}^2 \rightarrow \mathbb{CP}^2$.

Definition 1.24 A dual billiard structure at a point $A \in \mathbb{CP}^2$ is called *global (quasi-global)* if it is given by a projective angular symmetry (respectively, degenerate \mathcal{S} -angular symmetry) centered at A .

Definition 1.25 Consider a complex pencil of conics in \mathbb{CP}^2 . A vertex, i.e., a point of the ambient plane equipped with a complex dual billiard structure, is called *admissible* for the pencil, if it belongs to the following list of vertices split in two types: *standard*, or *skew*.

Case a): a pencil of conics through 4 distinct points A, B, C, D , no three of them being aligned, see Fig. 3, which will be referred to as a *non-degenerate pencil*.

a1) The *standard vertices*: $M_1 = AB \cap CD$, $M_2 = AD \cap BC$, $M_3 = AC \cap BD$ equipped with the global dual billiard structure given by the projective angular symmetry $\sigma_{M_j} = \sigma_{M_j}^{M_i M_k}$, $i, k \neq j$, $i \neq k$, centered at M_j with fixed point line $M_i M_k$.

a2) The *skew vertices* K_{EL} , numerated by unordered pairs of points $E, L \in \{A, B, C, D\}$, $E \neq L$: K_{EL} is the intersection point of the line EL with the line $M_i M_j$ such that $M_i, M_j \notin EL$. The involution $\sigma_{K_{EL}}$ is the projective angular symmetry $\mathbb{P}^2 \rightarrow \mathbb{P}^2$ centered at K_{EL} with fixed point line ST , $\{S, T\} = \{A, B, C, D\} \setminus \{E, L\}$.

Case b): a pencil of conics through 3 non-aligned points A, B, C tangent at the point C to the same line L ; here $A, B \notin L$. See Fig. 4.

³The projective angular symmetry and the degenerate \mathcal{S} -angular symmetry belong to the well-known class of birational involutions $\mathbb{CP}^2 \rightarrow \mathbb{CP}^2$ in the Cremona group, called *de Jonquières involutions*. Each of them is an involution fixing all but a finite number of lines through a given point $A \in \mathbb{CP}^2$. See, e.g., [14, p. 422, example 3.1].

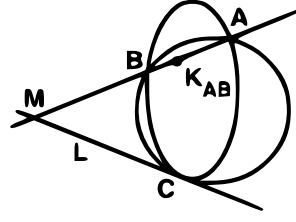

Figure 4: Case b)

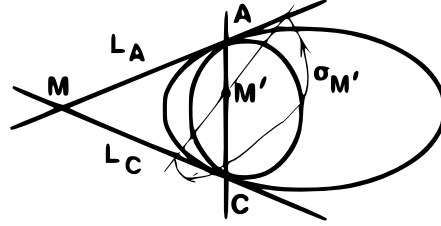

Figure 5: Case c)

b1) One *standard vertex* $M = AB \cap L$, equipped with the projective angular symmetry $\sigma_M : \mathbb{P}^2 \rightarrow \mathbb{P}^2$ centered at M with fixed point line CK_{AB} . The point K_{AB} is defined as follows.

b2) The *skew vertex* $K_{AB} \in AB$ such that the projective involution $AB \rightarrow AB$ fixing M and K_{AB} permutes A and B . That is, the points M, K_{AB}, A, B form a harmonic quadruple. The dual billiard structure at K_{AB} is given by the projective angular symmetry $\sigma_{K_{AB}} : \mathbb{P}^2 \rightarrow \mathbb{P}^2$ centered at K_{AB} with fixed point line L .

b3) The *skew vertex* C equipped with the projective angular symmetry $\sigma_C = \sigma_C^{AB} : \mathbb{P}^2 \rightarrow \mathbb{P}^2$ centered at C with fixed point line AB .

b4) The *skew vertex* C equipped with a degenerate \mathcal{S} -angular symmetry $\sigma_C = \sigma_C^{\mathcal{S}}$ centered at C , defined by arbitrary given regular conic \mathcal{S} of the pencil; see Definition 1.23. This yields a one-parametric family of quasi-global dual billiard structures at C .

Case c): a pencil of conics through two given distinct points A and C that are tangent at them to two given lines L_A and L_C respectively, $L_A, L_C \neq AC$. See Fig. 5.

c1) *Standard vertices*: $M = L_A \cap L_C$ and any point $M' \in AC$, $M' \neq A, C$. The vertex M is equipped with the projective angular symmetry σ_M centered at M with fixed point line AC . The vertex M' is equipped with the $(L_A \cup L_C)$ -angular symmetry centered at M' , which permutes the intersection points of each line through M' with the lines L_A and L_C .

c2) *Skew vertices equipped with global dual billiard structures*: the points A and C . The dual billiard structure at A (C) is the projective angular symmetry centered at A (C) with fixed point line L_C (respectively, L_A).

c3) *Skew vertices* A and C ; A (C) being equipped with a degenerate \mathcal{S}_A (\mathcal{S}_C)-angular symmetry centered at A (C), defined by any regular conic \mathcal{S}_A (\mathcal{S}_C) of the pencil. This yields a one-parametric family of quasi-global dual billiard structures at each one of the vertices A, C , as in b4).

Case d): pencil of conics through two distinct points A and B , tangent to each other at A with contact of order three, tangent to the same line $L \neq AB$ at A . See Fig. 6.

d1) The *skew vertex* A , equipped with a quasi-global dual billiard structure: a degenerate

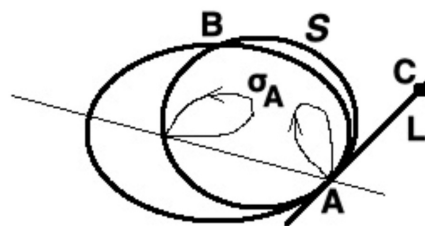

Figure 6: Case d)

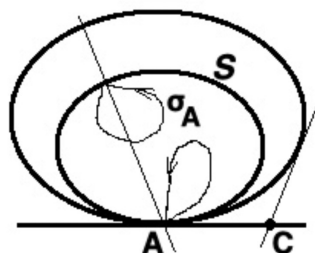

Figure 7: Case e)

\mathcal{S} -angular symmetry $\sigma_A^{\mathcal{S}}$ centered at A defined by any regular conic \mathcal{S} from the pencil.

d2) Any point $C \in L \setminus \{A\}$, called a *skew vertex*, equipped with a projective angular symmetry σ_C centered at C with fixed point line AB .

Case e): pencil of conics through one given point A , tangent to each other with contact of order four. See Fig. 7. Let L denote their common tangent line at A .

e1) The *skew vertex* A equipped with a degenerate \mathcal{S} -angular symmetry $\sigma_A^{\mathcal{S}}$ centered at A defined by any given regular conic \mathcal{S} of the pencil.

e2) Any point $C \in L \setminus \{A\}$, called a *standard vertex*, equipped with a projective angular symmetry σ_C centered at C . Its fixed point line is the set of those points $D \in \mathbb{P}^2$ for which the line CD is tangent to the conic of the pencil through D at D (including $D = A$).

The definition of real (standard or skew) admissible vertex for a real pencil of conics in \mathbb{RP}^2 is analogous.

Definition 1.26 Consider a dual multibilliard formed by some conics and maybe by some vertices. Let the dual billiard structure at each vertex (if any) be either global, or quasi-global, and that on each conic be either of pencil type, or as in Theorem 1.17, Case 2). We say that its two conics (vertices) are *distinct*, if they either are geometrically distinct, or coincide as conics (vertices) but have different dual billiard structures.

Definition 1.27 A (real or complex) dual multibilliard is said to be *of pencil type*, if the following conditions hold.

1) All its curves are conics lying in one pencil, and their dual billiard structures are defined by the same pencil. (Case of one conic equipped with a dual billiard structure of pencil type is possible.)

2) All its vertices are admissible for the pencil.

3) If the multibilliard contains a skew vertex equipped with a quasi-global dual billiard structure (which may happen only for a degenerate pencil), then it contains no other skew

vertex, with the following exceptions:

- in Case c) the skew vertex collection is allowed to be the pair of vertices A and C equipped with quasi-global structures defined by one and the same (but arbitrary) regular conic $\mathcal{S} = \mathcal{S}_A = \mathcal{S}_C$ of the pencil;

- in Case d) the skew vertex collection is allowed to be a pair of vertices A and C defined by any given regular conic \mathcal{S} of the pencil: the vertex A is equipped with the degenerate \mathcal{S} -angular symmetry centered at A ; the vertex C is the intersection point of the line L with the line tangent to \mathcal{S} at B , equipped with the projective angular symmetry centered at C with fixed point line AB (it coincides with the \mathcal{S} -angular symmetry).

4) In Case d) the multibilliard may contain at most one vertex $C \in L \setminus \{A\}$.

5) Each skew admissible vertex that a priori admits several possible dual billiard structures listed in Definition 1.25 is allowed to be included in the multibilliard with no more than one dual billiard structure.

Well-definedness of the above notion of admissible vertex and pencil type dual multibilliard in the real case is implied by the following proposition.

Proposition 1.28 *Consider a real pencil of conics in \mathbb{RP}^2 with **complex** base points.*

1) *An admissible vertex equipped with a global projective involution is real, if and only if its involution is real. A quasi-global involution associated to a skew vertex is real, if and only if the vertex and the fixed point conic \mathcal{S} are both real (i.e., invariant under complex conjugation).*

2) *Case a). At least one standard vertex M_j is real. (However in general M_j (K_{EL}) are not necessarily all real.)*

3) *Case b). All admissible vertices C, M, K_{AB} are always real.*

4) *Case c). The standard vertex M is real. The vertices A, C, M' are not necessarily real.*

5) *Case d) or e). The admissible vertex A is always real.*

Theorem 1.29 *Let a (real or complex) dual multibilliard on a collection of real C^4 -smooth (or holomorphic) nonlinear connected curves γ_j and some vertices be rationally integrable. Then the following statements hold.*

1) *Each curve γ_j is a conic equipped with a dual billiard structure either of pencil type, or exotic, see Theorem 1.17.*

2) *If the multibilliard contains at least two distinct conics (in the sense of Definition 1.26), then all the conics γ_j lie in the same pencil, and the dual billiard structures on them are defined by the same pencil.*

Theorem 1.30 *Let in a dual multibilliard all the curves be conics lying in the same pencil. Let them be equipped with the dual billiard structure defined by the same pencil. (Case of one conic equipped with a pencil type dual billiard structure is possible.) Then the multibilliard is rationally integrable, if and only if it is of pencil type, see Definition 1.27.*

Theorem 1.31 *The minimal degree of a rational integral of a pencil type multibilliard is*

(i) *degree two, if it contains no skew vertices;*

(ii) **degree 12**, *if the pencil has type a) and the multibilliard contains a pair of neighbor skew vertices: namely, a pair of vertices of type K_{EL} and K_{ES} for some three distinct $E, L, S \in \{A, B, C, D\}$.*

(iii) *degree four in any other case.*

The next theorem yields a formula for integral of degree 12 of pencil type multibilliards for pencils of type a). It is stated for multibilliards in $\mathbb{K}\mathbb{P}^2$, $\mathbb{K} = \mathbb{R}, \mathbb{C}$. To state it, let us introduce the following notations. Let $\mathbb{K}\mathbb{P}^2_{[y_1:y_2:y_3]}$ denote the ambient projective plane of the multibilliard, considered as the projectivization of the space $\mathbb{K}^3_{y_1, y_2, y_3}$. For every projective line $X \subset \mathbb{K}\mathbb{P}^2$ let $\pi^{-1}(X) \subset \mathbb{K}^3$ denote the corresponding two-dimensional subspace. Let $\xi_X(y)$, $y = (y_1, y_2, y_3)$, denote a non-zero linear functional vanishing on $\pi^{-1}(X)$. It is well-defined up to constant factor.

Theorem 1.32 *Consider a pencil of conics through four distinct base points A, B, C, D . Set $M_1 = AB \cap CD$, $M_2 = BC \cap AD$, $M_3 = AC \cap BD$.*

1) *The functionals ξ_{EL} corresponding to the lines EL through distinct points $E, L \in \{A, B, C, D\}$ can be normalized by constant factors so that*

$$\xi_{AB}\xi_{CD} + \xi_{BC}\xi_{AD} + \xi_{AD}\xi_{BC} = 0. \quad (1.23)$$

2) *If (1.23) holds, then for every $\mu \in \mathbb{C} \setminus 0$ the degree 12 rational function*

$$\prod_{\{EL; FN\} \neq \{E'L'; F'N'\}} \left(\frac{\xi_{EL}\xi_{FN}}{\xi_{E'L'}\xi_{F'N'}}(y) + \mu \right) \quad (1.24)$$

is a first integral of every pencil type multibilliard defined by the given pencil. Here the product is taken over ordered pairs $(\{EL; FN\}, \{E'L'; F'N'\})$ of distinct two-line sets⁴ with $\{E, L, F, N\} = \{E', L', F', N'\} = \{A, B, C, D\}$.

3) *In Theorem 1.31, Case (ii) product (1.24) is a minimal degree integral.*

Definition 1.33 Consider an exotic rationally integrable real (complex) dual billiard structure on conic, see Theorem 1.17, Case 2). The singular points of the dual billiard structure (which are exactly the indeterminacy points of the corresponding integral R from the Addendum to Theorem 1.17) will be called the *base points*.

Corollary 1.34 *Let a rationally integrable real (complex) multibilliard be not of pencil type. Then it contains only one curve, namely, a conic equipped with an exotic dual billiard structure, and maybe some vertices.*

⁴Or equivalently, product over ordered pairs of distinct unordered partitions of the set $\{A, B, C, D\}$ into two-element subsets $\{E, L\}, \{F, N\}$.

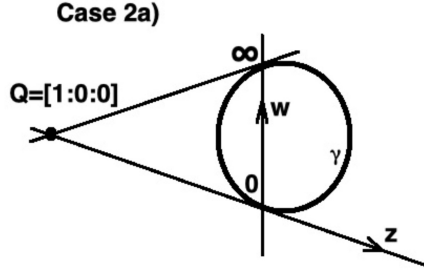

Figure 8: The only admissible vertex in Case 2a) is the point $Q = [1 : 0 : 0]$.

Theorem 1.35 *A (real or complex) multibilliard consisting of one conic γ equipped with an exotic dual billiard structure from Theorem 1.17, Case 2), and maybe some vertices is rationally integrable, if and only if the collection of vertices either is empty, or consists of the so-called **admissible vertices** Q defined below, being equipped with the γ -angular symmetry σ_Q :*

(i) *Case of type 2a) dual billiard on γ . The **unique admissible vertex** is the intersection point $Q = [1 : 0 : 0]$ of the z -axis and the infinity line; one has $\sigma_Q(z, w) = (-z, w)$ in the chart (z, w) . See Fig. 8. In Subcase 2a1), when $\rho = 2 - \frac{2}{2N+1}$, the function $R(z, w)$ from (1.9) is a rational integral of the multibilliard $(\gamma, (Q, \sigma_Q))$ of minimal degree: $\deg R = 4N + 2$. In Subcase 2a2), when $\rho = 2 - \frac{1}{N+1}$, the function $R^2(z, w)$ with R the same, as in (1.10), is a rational integral of $(\gamma, (Q, \sigma_Q))$ of minimal degree: $\deg R^2 = 4N + 4$.*

(ii) *Case of type 2b1) or 2b2). There are three base points. One of them, denoted X , is the intersection point of two lines contained in the polar locus $R = \infty$. The **unique admissible vertex** Q is the intersection point of two lines: the tangent line to γ at X and the line through the two other base points. In Case 2b1) the base points are $(0, 0)$, $[0 : 1 : 0]$, $X = (1, 1)$, and one has $Q = (0, -1)$. In Case 2b2) the base points are $(-1, 1)$, $(1, 1)$, $X = [0 : 1 : 0]$, and one has $Q = [1 : 0 : 0]$, $\sigma_Q(z, w) = (-z, w)$. The corresponding rational function R , see (1.11), (1.12) is a rational integral of the multibilliard $(\gamma, (Q, \sigma_Q))$ of minimal degree: $\deg R = 4$. See Fig. 9.*

(iii) *Case of type 2c1) or 2c2). There are three complex base points. There are **three admissible vertices**. Each of them is the intersection point of a line through two base points and the tangent line to γ at the other one. In Case 2c1) the base points are $(1, 1)$, $(\varepsilon, \bar{\varepsilon})$, $(\bar{\varepsilon}, \varepsilon)$, $\varepsilon = e^{\frac{2\pi i}{3}}$, and the point $(0, -1)$ is the unique real admissible vertex. In Case 2c2) the base points are $(0, 0)$, $(1, 1)$, $[0 : 1 : 0]$, and all the admissible vertices are real: they are $(0, -1)$, $(1, 0)$, $[1 : 1 : 0]$, see Fig. 9. The function R is a degree 6 rational integral of the multibilliard formed by the conic γ and arbitrary admissible vertex collection.*

(iv) *Case of type 2d). No admissible vertices.*

Proposition 1.36 *1) The two multibilliards of type (ii) (Cases 2b1), 2b2)) with one admissible vertex are complex-projectively equivalent. 2) Two multibilliards of type (iii) (either*

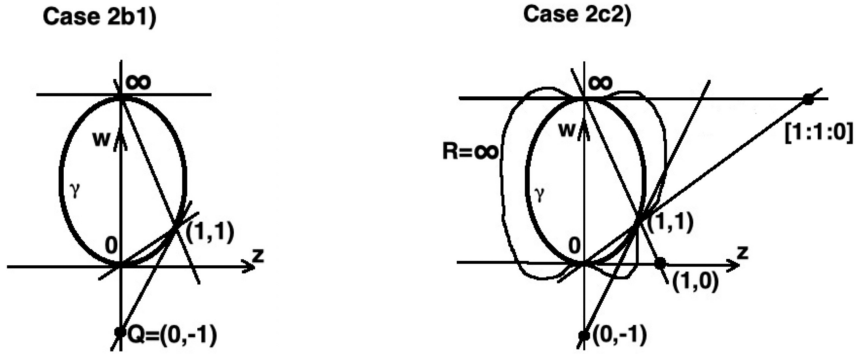

Figure 9: The admissible vertices in Cases 2b1) and 2c2) are marked in bold.

of different subtypes 2c1), 2c2), or of the same subtype) are complex-projectively equivalent, if and only if they have the same number of vertices. 3) Two real multibilliards of type (iii) with at least one vertex are real-projectively equivalent, if and only if they have either both subtype 2c1) and one real admissible vertex, or both subtype 2c2) and the same number (arbitrary, from 1 to 3) of real admissible vertices.

Proposition 1.36 will be deduced from the last statement of Theorem 1.18 and the fact that the exotic dual billiard of type 2c) has complex order three projective symmetry cyclically permuting admissible vertices; in subcase 2c2) the latter symmetry is real. It will be proved at the end of Subsection 2.5.

1.5 Application: classification of rationally 0-homogeneously integrable piecewise C^4 -smooth non-polygonal projective billiards

Let us recall the following definition.

Definition 1.37 [39, p. 962] The *central* projective billiard structure on a curve $C \subset \mathbb{R}^2$ with center $O \in \mathbb{R}^2$ is the field of lines through O on C .

Everywhere below for two projective lines e and f by ef we will denote their intersection point.

Definition 1.38 Consider a complex dual pencil of conics: a family of conics whose dual form a pencil. Let ℓ be a real or complex line equipped with a projective billiard structure; the corresponding (real or complex) line field is well-defined either on all of ℓ , or on ℓ punctured at one point called singular. The line ℓ is said to be *admissible* for the dual pencil, if it belongs to the following list of lines equipped with projective billiard structures, called either standard, or skew.

Case a): dual pencil of conics tangent to four distinct complex lines a, b, c, d .

a1) The three *standard admissible lines* are the lines m_1, m_2, m_3 through the points ab and cd , the points bc and ad , the points ac and bd respectively. The line m_1 is equipped with projective billiard structure centered at m_2m_3 , and the projective billiard structures on m_2, m_3 are defined analogously.

a2) Let k_{bc} denote the line through the points m_1m_3 and bc , equipped with the projective billiard structure centered at ad : the field of lines through ad . Let k_{ad} be the line through m_1m_3 and ad , equipped with the projective billiard structure centered at bc . The other lines $k_{ef}, e, f \in \{a, b, c, d\}, e \neq f$, equipped with central projective billiard structures are defined analogously. We identify k_{ef} with k_{fe} . All the six lines k_{ef} thus constructed are called *skew admissible lines*. See Fig. 10.

Case b): dual pencil of conics tangent to three distinct lines a, b, c and having common tangency point C with c . See Fig. 11. Let m denote the line through C and ab .

b1) The *skew line* c equipped with the field of lines through ab .

b2) The *skew line* k such that the quadruple of lines a, b, m, k through the point ab is harmonic. It is equipped with the field of lines through C .

b3) The *standard line* m with the field of lines through the point ck .

b4) For arbitrary given regular conic \mathcal{S} of the dual pencil the line c equipped with the field of lines tangent to \mathcal{S} (transversal to c outside the point C) is a *skew line*.

Case c): dual pencil of conics tangent to each other at two points A and B . Let a and b denote the corresponding tangent lines. See Fig. 12.

c1) The *standard line* $m = AB$ with the field of lines through ab .

c2) The *skew lines* a and b equipped with the fields of lines through B and A respectively.

c3) Fix an arbitrary line $c \neq a, b$ through ab . Let $Z \in m$ denote the point such that the quadruple of points $cm, Z, B, A \in m$ is harmonic. The line c equipped with the field of lines through Z is called a *skew line*.

c4) Fix regular conics $\mathcal{S}_A, \mathcal{S}_B$ from the dual pencil. The lines a and b , each being equipped with the field of lines tangent to \mathcal{S}_A (respectively \mathcal{S}_B) at points distinct from A and B respectively are called *skew lines*.

Case d): dual pencil of conics tangent to a given line a at a given point A , having triple contact between each other at A , and tangent to another given line $b \neq a$. See Fig. 13.

d1) The *skew line* a equipped with the line field tangent to a given (arbitrary) regular conic \mathcal{S} from the pencil.

d2) Any line $c \neq a$ through A called *skew*, equipped with the field of lines through the point ab .

Case e): dual pencil of conics tangent to each other at a point A with order 4 contact. Let a denote their common tangent line at A . See Fig. 14.

e1) The *skew line* a equipped with the line field tangent to a given (arbitrary) regular conic \mathcal{S} from the pencil.

e2) Any line b through A called *skew*, equipped with the field of lines tangent to the conics of the pencil at points of the line b : these tangent lines pass through the same point $C = C(b) \in a$.

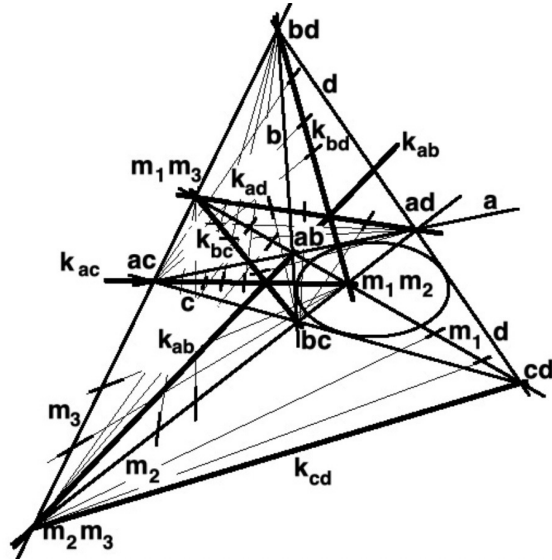

Figure 10: Dual pencil of type a). The standard admissible lines are m_1, m_2, m_3 . The skew admissible lines k_{ef} are marked in bold.

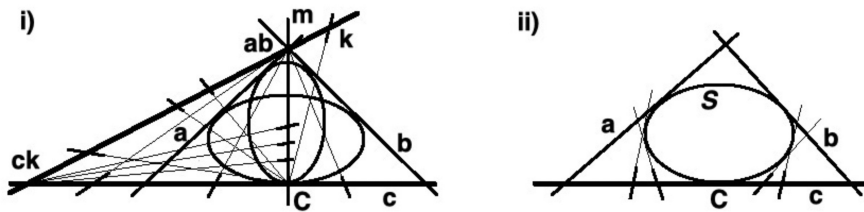

Figure 11: Dual pencil of type b): i) one standard line m and two skew lines c, k ; ii) skew line c with another line field, tangent to a given conic S .

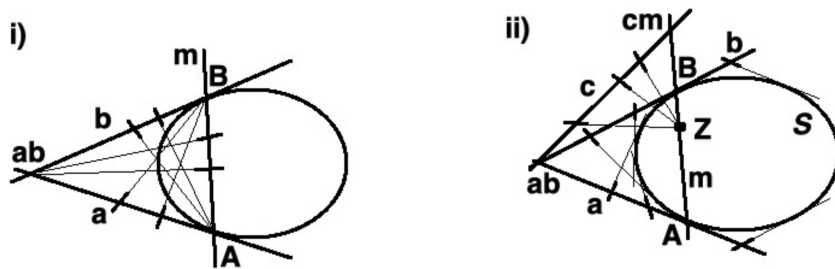

Figure 12: Dual pencil of type c): i) one standard line m and two skew lines a, b equipped with central projective billiard structures; ii) arbitrary line $c \neq a, b$ through ab (called skew) with field of lines through Z , and the skew lines a, b with fields of lines tangent to a given conic S from the pencil.

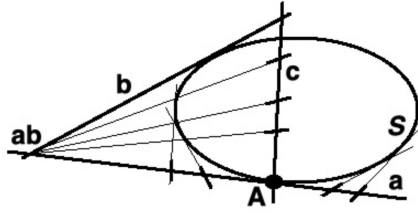

Figure 13: Dual pencil of type d): the skew line a and an arbitrary skew line $c \neq a$.

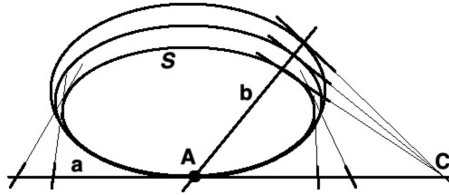

Figure 14: Dual pencil of type e): the skew line a and a standard line $b \neq a$.

Proposition 1.39 *In Case a) for every distinct $e, f, g \in \{a, b, c, d\}$ the lines k_{ef}, k_{fg}, k_{ge} pass through the same point. In particular, the line k_{ab} passes through the intersection points $k_{bd} \cap k_{ad}$ and $k_{ac} \cap k_{bc}$, see Fig. 10.*

Proof The two latter intersection points and the point m_2m_3 lie on one line, by the dual Desargues Theorem applied to the triangles $(bd, ad, k_{bd} \cap k_{ad})$ and $(ac, bc, k_{ac} \cap k_{bc})$: the intersection points m_1m_2, cd, m_1m_3 of pairs of lines containing the corresponding pairs of their sides lie on the same line m_1 ; hence, the lines through the corresponding pairs of vertices (ac, bd) (the line m_3), (bc, ad) (the line m_2), $(k_{bd} \cap k_{ad}, k_{ac} \cap k_{bc})$ pass through the same point, namely, m_2m_3 . The point ab lies on the line through the points $k_{bd} \cap k_{ad}$ and $k_{ac} \cap k_{bc}$, by Pappus Theorem applied to the triples of points bd, m_1m_3, ac and ad, m_1m_2, bc . The latter line is k_{ab} , since it passes through m_2m_3 . Proposition 1.39 is proved. \square

Definition 1.40 A projective billiard in \mathbb{R}^2 with *piecewise- C^4 -smooth boundary* having at least one nonlinear smooth arc is said to be of *dual pencil type*, if it satisfies the following conditions:

1) Each C^4 -smooth arc of the boundary is either a conical arc, or a segment. All the conical arcs lie in the same dual pencil and are equipped with the projective billiard structure defined by the same pencil.

2) The segments in the boundary are contained in lines admissible for the pencil and are equipped with the projective billiard structures of the ambient admissible lines.

3) If the boundary contains a skew line segment whose projective billiard structure is not a central one (hence, it is given by a field of lines tangent to a conic of the pencil),

then the boundary contains no segments of other skew lines with the following exceptions of possible ambient skew line collections:

- in Case c) the skew line collection is allowed to be the pair of lines a and b equipped with the fields of lines tangent to one and the same (but arbitrary) conic of the pencil;
- in Case d) the skew line collection is allowed to be a pair of lines a and c : a being equipped with the field of lines tangent to a given conic \mathcal{S} from the pencil; c is the line through the point A and the tangency point of the conic \mathcal{S} with the line b , equipped with the field of lines through the point ab .

4) In Case d) the boundary may contain a segment of at most one line $c \neq a$.

5) Each ambient skew line of a boundary segment that a priori admits several possible projective structures listed above is allowed to be included in the boundary with no more than one projective billiard structure.

Remark 1.41 The admissible standard (skew) vertices of a pencil are projective dual to the admissible standard (skew) lines of its dual pencil.

Theorem 1.42 *Let a planar projective billiard with piecewise C^4 -smooth boundary containing a nonlinear arc be rationally 0-homogeneously integrable. Then the following statements hold.*

1) *All the nonlinear arcs of the boundary are conical. Different arcs of the same conic are equipped with the restriction to them of one and the same projective billiard structure on the ambient conic: either of dual pencil type, or exotic, see Theorem 1.20.*

2) *If the boundary contains at least two arcs of two distinct regular conics, then all the ambient conics of nonlinear arcs lie in the same dual pencil and their projective billiard structures are defined by the same dual pencil.*

Theorem 1.43 *Let a planar projective billiard have piecewise C^4 -smooth boundary whose all nonlinear C^4 -smooth pieces are conical arcs lying in the same dual pencil and equipped with projective billiard structures defined by the same pencil. Then the billiard is 0-homogeneously rationally integrable, if and only if it is of dual pencil type.*

Theorem 1.44 *The minimal degree of 0-homogeneous rational integral of a dual pencil type projective billiard is*

- (i) *degree two, if its boundary contains no skew line segment;*
- (ii) **degree 12**, *if the dual pencil has type a) and the billiard boundary contains segments of some two so-called **neighbor** skew admissible lines: namely, lines k_{ef} , k_{fs} for some three distinct $e, f, s \in \{a, b, s, d\}$;*
- (iii) *degree four in any other case.*

Proposition 1.45 *A type a) dual pencil \mathcal{C}^* , i.e., a family of conics tangent to given four distinct complex lines, has a pair of **real** neighbor skew admissible lines, if and only if all their four common tangent lines are real. Thus, in this and only in this case \mathcal{C}^* admits a dual pencil type projective billiard with minimal degree of rational integral being equal to 12, see (ii).*

Theorem 1.46 Consider a type a) dual pencil of conics tangent to given four distinct real lines a, b, c, d . Let us consider the ambient plane \mathbb{R}_{x_1, x_2}^2 as the horizontal plane $\{x_3 = 1\} \subset \mathbb{R}_{x_1, x_2, x_3}^3$. Set

$$r := (x_1, x_2, 1) \in \mathbb{R}^3, \quad v = (v_1, v_2, 0) \text{ for every } (v_1, v_2) \in T_{(x_1, x_2)}\mathbb{R}^2,$$

$$\mathcal{M} = \mathcal{M}(r, v) := [r, v] = (-v_2, v_1, \Delta), \quad \Delta := x_1 v_2 - x_2 v_1. \quad (1.25)$$

In the above notations for intersection points em of lines e and m set

$$r(em) = (x_1(em), x_2(em), 1).$$

There exists a collection of three numbers $\chi_{em;fn} \in \mathbb{R}$, $\{e, m, f, n\} = \{a, b, c, d\}$, numerated by unordered pairs of intersection points $em = e \cap m$, $fn = f \cap n$ ($(em; fn) = (fn; em)$, by definition) such that

$$\sum_{(em;fn)} \chi_{em;fn} < r(em), \mathcal{M} > < r(fn), \mathcal{M} > = 0 \quad (1.26)$$

as a quadratic form in \mathcal{M} . This collection is unique up to common constant factor. For every $\mu \in \mathbb{R} \setminus \{0\}$ the corresponding expression

$$\prod_{(em;fn) \neq (e'm';f'n')} \left(\frac{\chi_{em;fn} < r(em), \mathcal{M} > < r(fn), \mathcal{M} >}{\chi_{e'm';f'n'} < r(e'm'), \mathcal{M} > < r(f'n'), \mathcal{M} >} + \mu \right) \quad (1.27)$$

is a degree 12 first integral of every projective billiard of dual pencil type defined by the pencil in question. Here the product is taken over ordered "big" pairs $((em; fn); (e'm'; f'n'))$ (or equivalently, over ordered pairs of distinct unordered partitions of the set $\{a, b, c, d\}$ into two-element subsets $\{e, m\}, \{f, n\}$).

Lemma 1.47 Consider the following segment lengths, see Fig. 15:

$$\rho := |bc - ab|, \quad t := |ab - bd|, \quad \tau := |ad - ab|, \quad s := |ab - ac|. \quad (1.28)$$

Here the lengths are oriented: lengths of two adjacent aligned segments (say, s and τ), are taken with the same sign, if their common end separates them (ab lies between the points ac and ad), and with opposite signs otherwise. Relation (1.26) (and hence, the statements of Theorem 1.46) hold for

$$(\chi_{ab;cd}, \chi_{bc;ad}, \chi_{ac;bd}) = \left(\frac{st}{\rho\tau} - 1, -\frac{st}{\rho\tau}, 1 \right). \quad (1.29)$$

Definition 1.48 Consider an exotic rationally integrable projective billiard structure on a conic γ , see Theorem 1.20, Case 2). Its singular points (which are the points, where the corresponding line field is either undefined, or tangent to γ) will be called the *base points*.

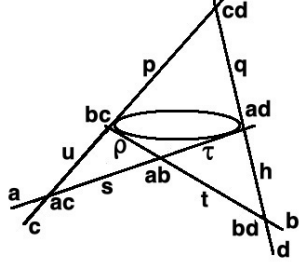

Figure 15: Pencil of type a). Distances between intersection points.

Corollary 1.49 *Let a rationally integrable projective billiard with piecewise C^4 -smooth boundary be not of dual pencil type. Let its boundary contain at least one nonlinear arc. Then all its nonlinear arcs lie in one conic, equipped with an exotic projective billiard structure from Theorem 1.20, Case 2).*

Theorem 1.50 *Let a projective billiard has piecewise smooth boundary consisting of arcs of one and the same conic γ equipped with an exotic projective billiard structure and maybe some straightline segments. The billiard is rationally integrable, if and only if the collection of ambient lines of the boundary segments either is empty, or consists of some of the following so-called **admissible lines** equipped with central projective billiard structures:*

(i) *Case of type 2a) projective billiard structure on γ ; $\rho = 2 - \frac{2}{m}$, $m \in \mathbb{N}$, $m \geq 3$. The unique admissible line is the vertical x_2 -axis, equipped with the normal (i.e., horizontal) line field. See Fig. 16. The projective billiard bounded by a half of γ and the x_2 -axis has a rational 0-homogeneous integral of minimal degree $2m$: the function Ψ_{2a1} from (1.16) for odd m ; the function Ψ_{2a2}^2 with Ψ_{2a2} the same, as in (1.17), for even m .*

(ii) *Case of type 2b1). The unique admissible line is the line $\{x_2 = 1\}$ equipped with the field of lines through the point $(0, -1)$.*

(iii) *Case of type 2b2). The unique admissible line is the x_2 -axis equipped with the normal (horizontal) line field. See Fig. 17. In both cases 2b1), 2b2) the functions Ψ_{2b1} , Ψ_{2b2} from (1.18) and (1.19) are integrals of minimal degree 4 for each billiard bounded by γ and the admissible line.*

(iv) *Case of type 2c1). The unique admissible line is the line $\{x_2 = 1\}$ equipped with the field of lines through the point $(0, -1)$.*

(v) *Case of type 2c2). There are three admissible lines:*

- *the line $\{x_2 = 1\}$, with the field of lines through the point $(0, -1)$;*
- *the line $\{x_1 = -\frac{1}{2}\}$, with the line field parallel to the vector $(-1, 1)$;*
- *the line $\{x_2 = -2x_1\}$, with the field of lines through the point $(-1, 0)$.*

See Fig. 18. In both cases 2c1), 2c2) the corresponding functions Ψ_{2c1} , Ψ_{2c2} from (1.20) and (1.21) are integrals of minimal degree 6 for each billiard bounded by γ and segments of

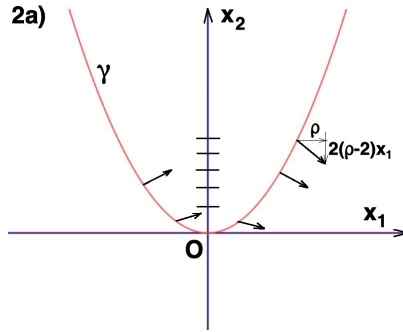

Figure 16: The only admissible line in Case 2a) is the x_2 -axis.

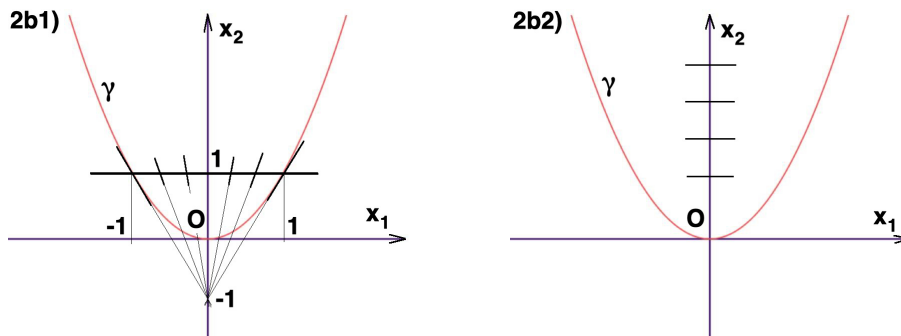

Figure 17: The only admissible line in Case 2b1) is the line $\{x_2 = 1\}$. The only admissible line in Case 2b2) is the x_2 -axis.

admissible lines.

(vi) *Case of type 2d). No admissible lines.*

1.6 Plan of proofs of main results

Step 1. In Subsection 2.1 we prove rational integrability of pencil type complex multibilliard. (This implies analogous result in the real case.) To do this, we show that for every pencil all the involutions associated to all the corresponding admissible vertices preserve the pencil and act on its parameter space $\overline{\mathbb{C}}$ by conformal involutions (Proposition 2.1). We fix an arbitrary collection of admissible vertices and consider the subgroup $G \subset \text{Aut}(\overline{\mathbb{C}}) = \text{PSL}_2(\mathbb{C})$ generated by the corresponding conformal involutions. We show that finiteness of the group G is equivalent to the system of Conditions 3)–5) of Definition 1.27 of pencil type multibilliard (Proposition 2.4), and in this case G is either trivial, or isomorphic to either \mathbb{Z}_2 , or S_3 . We then deduce rational integrability of every pencil type multibilliard with integral of degree $2|G| \in \{2, 4, 12\}$.

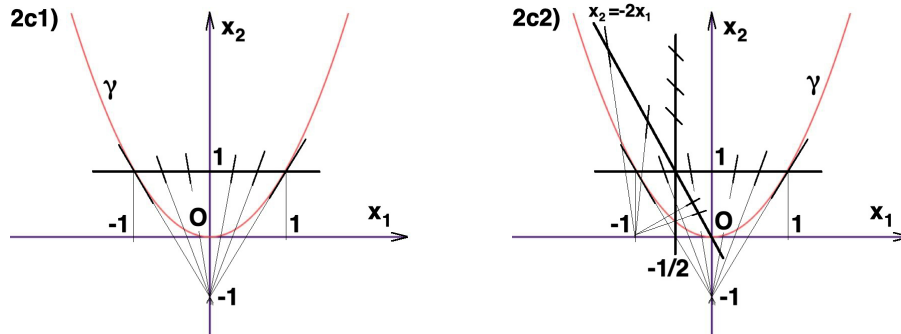

Figure 18: The only admissible line in Case 2c1) is the line $\{x_2 = 1\}$. In Case 2c2) there are three admissible lines: $\{x_2 = 1\}$; $\{x_1 = -\frac{1}{2}\}$, $\{x_2 = -2x_1\}$.

To classify rationally integrable dual multibilliards, in what follows we consider an arbitrary dual multibilliard with a rational integral Ψ . Each its curve is already known to be a conic equipped with either a pencil type dual billiard structure, or an exotic billiard structure from Theorem 1.17, Case 2). We fix some its conic \mathcal{S} and consider the canonical integral R of its dual billiard structure: either a quadratic integral in the case of pencil, or the corresponding integral from the Addendum to Theorem 1.17.

Step 2. In Subsection 2.2 we show that the singular foliations $\Psi = const$ and $R = const$ on $\mathbb{C}\mathbb{P}^2$ coincide (Proposition 2.7). We show that a generic level curve of the integral R is irreducible, of the same degree $d = \deg R$, and thus, R is a rational first integral of minimal degree for the above foliation. In the exotic case we also show that the conic \mathcal{S} is its unique level curve of multiplicity d , which means that the irreducible level curves of the function R accumulating to \mathcal{S} converge to $\frac{d}{2}[\mathcal{S}]$ as divisors: the intersection of a small cross-section to \mathcal{S} with a level curve close to \mathcal{S} consists of $\frac{d}{2}$ points (Lemma 2.8).

Step 3. We then deduce (in Subsection 2.2) that if on some conic of the multibilliard the dual billiard structure is defined by a pencil (or if the multibilliard contains at least two distinct conics), then the above foliation coincides with the pencil and the dual billiard structures on all the other conics are defined by the same pencil. This will prove Theorem 1.29. Results of Step 1 together with constance of integral on the conics of the pencil (given by Step 2) imply Theorem 1.31.

Step 4. In Subsection 2.3 we study vertices of the multibilliard. First we show that the family of involutions $\sigma_{A,\ell} : \ell \rightarrow \ell$ associated to each vertex A is given by the restrictions to the lines ℓ through A of a birational involution $\sigma_A : \mathbb{C}\mathbb{P}^2 \rightarrow \mathbb{C}\mathbb{P}^2$ preserving the foliation $\Psi = const$ (Proposition 2.10). Then we deduce that each σ_A is either a projective angular symmetry, or a degenerate \mathcal{S} -angular symmetry defined by a regular conic \mathcal{S} through A . We show that in the latter case the foliation $\Psi = const$ is a pencil of conics containing \mathcal{S} (Lemma 2.11).

Step 5. In Subsection 2.4 we prove Theorem 1.30. It deals with the case, when the foliation $\Psi = const$ is a pencil of conics. We show that each vertex of the multibilliard is

admissible (Proposition 2.13). Each level curve of the function Ψ is a collection of at most $\frac{\deg \Psi}{2}$ conics of the pencil, and it is invariant under the involutions defining the dual billiard structures at the vertices. This implies finiteness of the group G generated by the conformal involutions corresponding to the vertices. Together with the results of Step 1 (Subsection 2.1), this implies that the multibilliard is of pencil type.

In Subsection 2.5 we prove Theorem 1.35 on classification of exotic multibilliards: rationally integrable multibilliards consisting of a conic \mathcal{S} with an exotic dual billiard structure and (may be) some vertices. First we prove integrability of exotic multibilliards with admissible vertices (Proposition 2.14). Then we consider an arbitrary exotic multibilliard and show (Proposition 2.16) that its vertices are admissible, by using the result of Step 4 stating that the corresponding involutions are projective angular symmetries. At the end of the same subsection we prove Proposition 1.36.

In Subsection 2.6 we prove Propositions 1.28 and 1.45.

In Section 3 we prove the main results on classification of rationally 0-homogeneously integrable piecewise C^4 -smooth projective billiards (Theorems 1.42, 1.43, 1.44, 1.50). We reduce them to the main results on dual multibilliards via the projective duality given by orthogonal polarity. We prove bijectivity of the correspondence (given in Remark 1.12) between rational integrals of a multibilliard and rational 0-homogeneous integrals of the flow of its dual projective billiard. This together with the results from [30] on duality between exotic dual billiards from Theorem 1.17 and exotic projective billiards from Theorem 1.20 and the results of the present paper on dual multibilliards will imply the main results on projective billiards.

In Section 4 we prove Theorems 1.32, 1.46 and Lemma 1.47 and give examples of projective billiards with integrals of degrees 4 and 12.

1.7 Historical remarks

Existence of a continuum of closed caustics in every strictly convex bounded planar billiard with sufficiently smooth boundary was proved by V.F.Lazutkin [35]. Existence of continuum of foliations by (non-closed) caustics in open billiards was proved by the author [29]. H.Poritsky [37] (and later E.Amiran [2]) proved the Birkhoff Conjecture under the additional assumption that for every two caustics the smaller one is a caustic for the bigger one. M.Bialy [4] proved that if the phase cylinder is foliated by non-contractible invariant curves for the billiard map, then the billiard table is a disk. See also [46], where another proof of Bialy's result was given, and Bialy's papers [5, 6] for similar results on billiards on constant curvature surfaces and on magnetic billiards on these surfaces. D.V.Treschev conjectured existence of billiards where the squared billiard map has a fixed point where its germ is analytically conjugated to an irrational rotation and confirmed this by numerical experiments: in two dimensions [41, 42] and in higher dimensions [43]. V.Kaloshin and A.Sorrentino [31] proved that *any integrable deformation of an ellipse is an ellipse*; here "integrable" means "having caustics tangent to families of periodic orbits (called rational caustics) of *all* rotation numbers $\frac{1}{q}$, $q \geq 3$." See [1] for previous similar result in the case of ellipses with small excentricities. A similar result with rational caustics of all rotation

numbers small enough was very recently proved by Illya Koval for almost every ellipse [33]. M.Bialy and A.B.Mironov proved the Birkhoff Conjecture for centrally-symmetric billiards admitting a continuous family of caustics extending up to a caustic of 4-periodic orbits [13]. For a dynamical entropic version of the Birkhoff Conjecture and related results see [36]. For a survey on the Birkhoff Conjecture and results on it see [13, 31, 32] and references therein.

A.P.Veselov proved a series of complete integrability results for billiards bounded by confocal quadrics in space forms of any dimension and described billiard orbits there in terms of a shift of the Jacobi variety corresponding to an appropriate hyperelliptic curve [44, 45]. Dynamics in (not necessarily convex) billiards of this type was also studied in [18, 19, 20, 21, 22].

The Polynomial Birkhoff Conjecture together with its generalization to piecewise smooth billiards on surfaces of constant curvature was stated by S.V.Bolotin and partially studied by himself, see [15], [16, section 4], and by M.Bialy and A.E.Mironov [7]. Its complete solution is a joint result of M.Bialy, A.E.Mironov and the author given in the series of papers [9, 10, 27, 28]. For a survey of Bolotin's Polynomial Birkhoff Conjecture and of its version for magnetic billiards (an open conjecture, with a substantial progress made in [8, 11]) and related results see [8, 9, 10, 11, 12, 28, 30, 32, 34] and references therein.

The generalization of the Birkhoff Conjecture to dual billiards was stated by S.Tabachnikov in [40]. Its rationally integrable version was solved by the author of the present paper in [30]. Its polynomially integrable version for outer billiards was stated and partially studied in [40] and solved completely in [26]. In [39] S.Tabachnikov has proved a criterion of existence of an invariant area form for strictly convex closed projective billiards. He has shown there that if a projective billiard on circle has an invariant area form smooth up to the boundary of the phase cylinder, then it is integrable.

A series of results on the analogue of Ivrii Conjecture on periodic orbits in billiard (stating that their Lebesgue measure is zero) for projective billiards was obtained by C.Fierobe [23, 24, 25].

2 Rationally integrable dual multibilliards. Proofs of Theorems 1.29, 1.30, 1.31, 1.35

2.1 Rational integrability of pencil type multibilliards

Proposition 2.1 *Consider a complex pencil of conics and the corresponding admissible vertices. For every standard vertex the corresponding involution leaves invariant each conic of the pencil. For every skew vertex the corresponding involution permutes conics of the pencil non-trivially: it acts as a conformal involution of the parameter space $\overline{\mathbb{C}}$ of the complex pencil.*

Proof Case a): pencil of conics through four distinct base points A, B, C, D , see Fig. 3. In this case no three of them lie on the same line. This implies that the three vertices M_j are well-defined, distinct, do not lie on the same line and different from the base points,

and so are the vertices K_{EL} , and the latter are distinct from the vertices M_j . Set

$$\Gamma_1 := AB \cup CD, \Gamma_2 := BC \cup AD, \Gamma_3 = AC \cup BD. \quad (2.1)$$

Let $\sigma_{M_1} : \mathbb{CP}^2 \rightarrow \mathbb{CP}^2$ be the Γ_2 -angular symmetry centered at M_1 : the projective involution fixing each line through M_1 and permuting its intersection points with the lines AD and BC . It permutes the points A and B , C and D . Hence, it preserves the pencil. It fixes the line M_2M_3 , which passes through the points $AD \cap BC$ and $AC \cap BD$. Hence, it fixes each its point X , since it fixes the line M_1X . The pencil is parametrized by a parameter $\lambda \in \overline{\mathbb{C}}$, and σ_{M_1} acts on $\overline{\mathbb{C}}_\lambda$ by conformal automorphism. Let $\lambda_1, \lambda_2, \lambda_3 \in \overline{\mathbb{C}}$ denote the parameter values corresponding to the singular conics $\Gamma_1, \Gamma_2, \Gamma_3$ respectively. Each Γ_j is σ_{M_1} -invariant, by construction. Therefore, the conformal automorphism $\overline{\mathbb{C}} \rightarrow \overline{\mathbb{C}}$ induced by σ_{M_1} fixes three distinct points $\lambda_1, \lambda_2, \lambda_3$. Hence, it is identity, and σ_{M_1} preserves each conic of the pencil. This proof is also valid for the other vertices M_j .

The involution $\sigma_{K_{BC}}$ is the projective angular symmetry centered at K_{BC} with fixed point line AD . Hence, it fixes M_2 .

Claim 1. *The involution $\sigma_{K_{BC}}$ permutes B and C . Or equivalently, the quadruple of points K_{BC}, M_2, B, C on the line BC is harmonic.*

Proof The restriction of the involution $\sigma_{K_{BC}}$ to the line BC coincides with the involution σ_{M_2} , since both of them are non-trivial projective involutions of the line BC fixing K_{BC} and M_2 . The involution σ_{M_2} permutes B and C , as in the above discussion on σ_{M_1} . Hence, so does $\sigma_{K_{BC}}$. \square

Corollary 2.2 *Each one of the involutions $\sigma_{K_{BC}}, \sigma_{K_{AD}}$ preserves the pencil, fixes Γ_2 and permutes Γ_1, Γ_3 . Hence, it yields a non-trivial conformal involution $\overline{\mathbb{C}}_\lambda \rightarrow \overline{\mathbb{C}}_\lambda$ of the parameter space of the pencil, fixing λ_2 and permuting λ_1, λ_3 .*

Proof The involution $\sigma_{K_{BC}}$ fixes A, D and permutes B, C . Similarly, the involution $\sigma_{K_{AD}}$ fixes B, C and permutes A, D . \square

Case b): pencil of conics through three distinct points A, B, C , tangent at the point C to the same line L , see Fig. 4. The involution σ_M fixes the points C, K_{AB} , the line L and permutes A and B , by definition and harmonicity of the quadruple M, K_{AB}, A, B . Therefore, it preserves the pencil. Similarly, the involution $\sigma_{K_{AB}}$ preserves the pencil. And so does the involution $\sigma_C : \mathbb{CP}^2 \rightarrow \mathbb{CP}^2$ defined to fix C and each point of the line AB . Now the pencil, parametrized by a parameter $\lambda \in \overline{\mathbb{C}}$, contains just two singular conics:

$$\Gamma_1 := AB \cup L, \Gamma_2 := AC \cup BC, \quad (2.2)$$

corresponding to some parameter values λ_1 and λ_2 .

Claim 2. *The involution σ_M and the composition $\sigma_C \circ \sigma_{K_{AB}}$ preserve each conic of the pencil. Each one of the involutions $\sigma_C, \sigma_{K_{AB}}$ fixes only the conics Γ_1, Γ_2 of the pencil.*

Proof The pencil in question is the limit of a family of pencils of conics through A, B, C_μ, D_μ with basic points C_μ, D_μ depending on small parameter μ , confluent to C , as

$\mu \rightarrow 0$, so that the line $C_\mu D_\mu$ passes through $M = M_1$ and tends to the tangent line L , as $\mu \rightarrow 0$. Then $M_2 = M_2(\mu) \rightarrow C$, $M_3 = M_3(\mu) \rightarrow C$, and the involutions $\sigma_{M_1} = \sigma_{M_1(\mu)}$ corresponding to the perturbed pencil, with $\mu \neq 0$, converge to σ_M , as $\mu \rightarrow 0$. The involution $\sigma_{M_1(\mu)}$ preserves each conic of the pencil for $\mu \neq 0$. Hence, so does its limit σ_M . The involutions at the vertices $K_{C_\mu D_\mu}$, K_{AB} converge to σ_C and $\sigma_{K_{AB}}$, by construction. They act on the perturbed pencil as non-trivial involutions, permuting conics in the same way (Corollary 2.2). Hence, this statement remains valid for their limits σ_C and $\sigma_{K_{AB}}$. The claim is proved. \square

Proposition 2.3 *Consider a pencil of complex conics that are tangent to each other at a point C . Let \mathcal{S} be its regular conic, and let C be equipped with the quasi-global dual billiard structure defined by \mathcal{S} . Then the corresponding involution σ_C preserves the pencil and induces a non-trivial conformal involution $\overline{\mathbb{C}} \rightarrow \overline{\mathbb{C}}$ of its parameter space.*

Proof Let L denote the common projective tangent line at C to the regular conics of the pencil. Let us take an affine chart $\mathbb{C}_{z,w} = \mathbb{CP}^2 \setminus L$ so that C is the intersection point of the w -axis with the infinity line L . Then the conics of the pencil are parabolas $\mathcal{S}_\lambda := \{w = (a_1 z^2 + b_1 z + c_1) + \lambda(a_2 z^2 + b_2 z + c_2)\}$. Let us normalize the parameter λ so that $\mathcal{S}_0 = \mathcal{S}$. Then in the affine chart (z, w) one has

$$\sigma_C(z, w) = (z, 2(a_1 z^2 + b_1 z + c_1) - w).$$

Hence, $\sigma_C(\mathcal{S}_\lambda) = \mathcal{S}_{-\lambda}$. The proposition is proved. \square

Case c): pencil of conics through two distinct points A and C tangent to two given lines L_A and L_C through them; $L_A, L_C \neq AC$. See Fig. 5. Fix an arbitrary point $M' \in AC \setminus \{A, C\}$.

Claim 3. *The projective angular symmetries σ_A , σ_C with fixed point lines L_C and L_A respectively preserve the pencil. The involutions σ_M , $\sigma_{M'}$ and the composition $\sigma_A \circ \sigma_C$ preserve each conic of the pencil.*

Proof The involutions σ_M , $\sigma_{M'}$, σ_A , σ_C preserve the pencil, since they are projective transformations preserving the collections of its defining points and lines. There exists an affine chart (x_1, x_2) in which M' is the origin, $L_C = \{x_2 = -1\}$, $L_A = \{x_2 = 1\}$, M is the intersection point of the infinity line with the x_1 -axis. In this chart the conics of the pencil are complexified ellipses centered at $M' = (0, 0)$ for which the segment AC is an axis. The involutions σ_M and $\sigma_{M'}$ are the symmetries with respect to the x_2 -axis and the origin respectively, and they obviously preserve each ellipse of the pencil. The involutions σ_A , σ_C preserve its two conics: $L_A \cup L_C$ and the double line AC . Each of them acts on the parameter space $\overline{\mathbb{C}}_\lambda$ of the pencil nontrivially. Indeed, σ_A cannot preserve a regular conic S of the pencil: otherwise a line ℓ through A distinct from AC would intersect S at a point of the fixed point line L_C distinct from C . Thus, S would intersect the line L_C with index at least three, which would contradict the Bézout Theorem. Thus, σ_A , σ_C act on $\overline{\mathbb{C}}_\lambda$ as non-trivial conformal involutions with the same fixed point pair. Therefore, the latter involutions coincide, and their product is the identity map of $\overline{\mathbb{C}}_\lambda$. The claim is proved. \square

Consider the skew vertices in Cases c), d), e) equipped with quasi-global dual billiard structures. The corresponding involutions preserve the pencil and induce non-trivial conformal involutions of $\overline{\mathbb{C}}_\lambda$, by Proposition 2.3.

Consider now the vertices C in Cases d) and e). In Case d) the involution σ_C preserves the singular conic $L \cup AB$ of the pencil and the conic tangent to BC at B , as σ_M in Claim 3. Hence, it preserves the pencil. It does not preserve other conics, since their tangent lines at B are not σ_C -invariant. In Case e) σ_C preserves each conic of the pencil. This can be seen in the affine chart (z, w) for which C, A are the intersection points of the infinity line with the z - and w -axes respectively, and the conics are the parabolas $w = z^2 + \lambda$: $\sigma_C(z, w) = \sigma_C(-z, w)$. Proposition 2.1 is proved. \square

Proposition 2.4 *Let in a complex dual multibilliard all the curves be conics lying in a pencil, and their dual billiard structures be defined by the same pencil. Let all its vertices be admissible for the pencil. Let $G \subset PSL_2(\mathbb{C}) = \text{Aut}(\overline{\mathbb{C}})$ denote the group generated by conformal transformations of the parameter space $\overline{\mathbb{C}}$ of the pencil induced by the involutions associated to the vertices, see Proposition 2.1. Then the following statements are equivalent:*

- (i) *The group G is finite.*
- (ii) *The vertex collection satisfies Conditions 3)–5) of Definition 1.27.*

If the group G is finite, then it is either trivial (if and only if the multibilliard contains no skew vertex), or isomorphic to \mathbb{Z}_2 or S_3 . One has $G = S_3$, if and only if the pencil has type a) and the multibilliard contains a pair of neighbor skew vertices K_{EX}, K_{EY} .

Proof Case of pencil of type a). Then Conditions 3)–5) of Definition 1.27 impose no restriction on admissible vertex collection. The involution defining the dual billiard structure at each admissible vertex preserves the triple of the singular conics $\Gamma_1, \Gamma_2, \Gamma_3$ of the pencil, see (2.1). Therefore, the conformal involutions $\overline{\mathbb{C}} \rightarrow \overline{\mathbb{C}}$ of the parameter space defined by the skew vertices permute the corresponding parameter values $\lambda_1, \lambda_2, \lambda_3$. The above conformal involutions (and their compositions) are uniquely determined by the corresponding permutations. Hence, they generate a finite subgroup $G \subset PSL_2(\mathbb{C})$ isomorphic to a subgroup of S_3 . The conformal involution corresponding to a standard vertex is trivial. Each one of the involutions $\sigma_{K_{BC}}, \sigma_{K_{AD}}$ fixes Γ_2 and permutes Γ_1, Γ_3 (Corollary 2.2). Similarly, each of $\sigma_{K_{AB}}, \sigma_{K_{CD}}$ fixes Γ_1 and permutes Γ_2, Γ_3 . The two latter permutations generate all of S_3 . This implies that G either is all of S_3 , or reduces to one transposition and hence, isomorphic to \mathbb{Z}_2 . This implies the statements of Proposition 2.4.

Case of pencil of type b). For every skew vertex equipped with a projective angular symmetry the latter symmetry fixes only the parameter values λ_1, λ_2 corresponding to the singular conics Γ_1, Γ_2 from (2.2), see Claim 2 in the proof of Proposition 2.1.

Suppose the multibilliard contains only skew vertices of the above type and maybe some standard vertices. Then the group G is either trivial (if the skew vertex subset is empty), or isomorphic to \mathbb{Z}_2 (if it is non-empty), by the above statement.

Let now the multibilliard contain the skew vertex C equipped with a degenerate \mathcal{S} -angular symmetry defined by a regular conic \mathcal{S} of the pencil. Let $\lambda_{\mathcal{S}}$ denote the parameter value corresponding to \mathcal{S} . The conformal involution corresponding to the vertex C fixes

only λ_2 and λ_S . Therefore, if the multibilliard contains no other skew vertices, then $G \simeq \mathbb{Z}_2$. If it contains another skew vertex, then G is generated by two involutions having only one common fixed point λ_2 . Their composition is a parabolic transformation with the unique fixed point λ_2 . It has infinite order. Hence, G is infinite.

Case of pencil of type c) is treated analogously.

Case of pencil of type d). The involution σ_C corresponding to a skew vertex $C \in L \setminus \{A\}$ is a projective angular symmetry fixing two conics: the singular conic $L \cup AB$ and the regular conic \mathcal{S} of the pencil that is tangent to the line CB at B . The correspondence $\mathcal{S} \mapsto C$ is bijective. This implies that G is finite, if and only if the involution corresponding to any other skew vertex of the multibilliard fixes the same conic \mathcal{S} , as in the above discussion. This holds, if and only if Conditions 3)–5) of Definition 1.25 hold.

Case of pencil of type e) is treated analogously, with the singular conic now being the double line L . Proposition 2.4 is proved. \square

Proposition 2.5 *Every pencil type multibilliard has a rational integral of degree $2|G| \in \{2, 4, 12\}$, where $|G|$ is the cardinality of the group G .*

Proof The group G is finite, by Proposition 2.4 and since the multibilliard is of pencil type (hence, satisfying Conditions 3)–5) of Definition 1.25). Let F be a quadratic first integral of the pencil: the ratio of two quadratic polynomials defining two its conics. Its constant value on each conic coincides with the corresponding parameter λ (after replacing F by its post-composition with conformal automorphism $\overline{\mathbb{C}} \rightarrow \overline{\mathbb{C}}$). The product $\prod_{g \in G} g \circ F$ is a rational first integral of the multibilliard, since it is invariant under the vertex involutions (by definition) and the dual billiard involution of each tangent line to a multibilliard conic permutes its intersection points with each conic of the pencil. Proposition 2.5 is proved. \square

2.2 Foliation by level curves of rational integral. Proof of Theorems 1.29 and 1.31

Definition 2.6 Consider a rationally integrable dual billiard structure on a complex conic γ (which belongs to the list given by Theorem 1.17). In the case, when it is defined by a pencil of conics, its *canonical integral* is a quadratic rational function constant on each conic of the pencil that vanishes on γ . In the case, when it is exotic, its *canonical integral* is the one given by the Addendum to Theorem 1.17 (whose zero locus is γ).

Proposition 2.7 *Every rational integral of a rationally integrable dual billiard on a conic is constant on each irreducible component of each level curve of its canonical integral.*

Proof Let γ be the conic in question, Ψ be a rational integral of the dual billiard, and let R be its canonical integral. We have to show that $\Psi \equiv \text{const}$ along the leaves of the foliation $R = \text{const}$ (which are, by definition, the irreducible components of level curves of the function R with its critical and indeterminacy points deleted). It suffices to prove the above statement in a small neighborhood of the conic γ . Fix a point $P \in \gamma$ such that

it is a regular point for the foliation and the dual billiard involution σ_P is defined there. (In fact, σ_P is well-defined whenever P is regular for the foliation. But we will not use this.) Let $U \subset \mathbb{C}\mathbb{P}^2$ be a small neighborhood of the point P that is a flowbox for the foliation $R = \text{const}$ and whose closure is disjoint from singular points of the foliation and indeterminacy points for the involution family σ_t , $t \in \gamma$. We equip it with biholomorphic coordinates (x, y) , where the local leaves of the flowbox are the horizontal fibers $y = \text{const}$. Fix a point $P_0 \notin \gamma$ close to P . Take a tangent line ℓ_0 to γ through P_0 ; let Q_0 denote the tangency point. Set $P_1 = \sigma_{Q_0}(P_0)$. Let ℓ_1 be the tangent line to γ through P_1 distinct from ℓ_0 , and let Q_1 be their tangency point. Set

$$P_2 = \sigma_{Q_1}(P_1), \text{ etc. } P_N = \sigma_{Q_{N-1}}(P_{N-1}); \quad x_j = x(P_j).$$

Here N is the biggest number such that $P_1, \dots, P_N, Q_0, \dots, Q_{N-1} \in U$. We claim that as $P_0 \rightarrow P$, the cardinality $N = N(P_0)$ of the above sequence tends to infinity. This follows from the fact the involutions $\sigma_Q|_{L_Q}$, $Q \in \gamma \cap U$ are uniformly asymptotic to the central symmetries $x \mapsto 2x(Q) - x$ with respect to the points $x(Q)$, as $x - x(Q) \rightarrow 0$ and $Q \in U$: they are non-trivial conformal involutions of the lines L_Q with fixed points Q . Therefore, $N > \deg \Psi \deg R$, whenever P_0 is close enough to P . One has

$$\Psi(P_0) = \dots = \Psi(P_N), \quad R(P_0) = \dots = R(P_N),$$

since both Ψ and R are integrals. This together with Bezout Theorem and the above inequality implies that $\Psi \equiv \text{const}$ along each leaf of the foliation $R = \text{const}$. Proposition 2.7 is proved. \square

Lemma 2.8 *Let R be a rational first integral of an exotic dual billiard structure from Theorem 1.17 given by the corresponding formula in its addendum.*

1) *For all but a finite number of values of $\lambda \in \mathbb{C}$ the complex level curve*

$$\Gamma_\lambda := \{R = \lambda\}$$

is irreducible of degree $d = \deg R$.

2) *The (punctured) curve $\gamma = \{w = z^2\}$ is a **multiplicity $\frac{d}{2}$ leaf** of the foliation $R = \text{const}$, which means that each small transversal cross-section to γ intersects each leaf close enough to γ (depending on cross-section) transversely at $\frac{d}{2}$ distinct points; moreover, $[\Gamma_\lambda] \rightarrow \frac{d}{2}[\gamma]$ as divisors, as $\lambda \rightarrow 0$.*

3) *The curve γ is the unique nonlinear multiplicity $\frac{d}{2}$ leaf.*

Proof For the proof of Statement 1) it suffices to prove irreducibility of the level curve Γ_λ for an open subset of values λ . We will prove this for generic small λ : for an open set of values λ accumulating to zero (for all $\lambda \neq 0$ small enough in Cases 2a1), 2a2).) Indeed, it is well-known that if the level curve $\{R = \lambda\}$ of a rational function is irreducible for an open subset of values λ , then it is irreducible for all but a finite number of λ . This is implied by the two following statements:

- each indeterminacy point can be resolved by a sequence of blow-ups, so that the function in question becomes a well-defined $\overline{\mathbb{C}}$ -valued holomorphic function on a new connected compact manifold, a blown-up $\mathbb{C}\mathbb{P}^2$;

- every non-constant holomorphic $\overline{\mathbb{C}}$ -valued function on a connected compact complex manifold has finite number of critical values.

Let us first consider Case 2a1), when $R(z, w) = \frac{(w-z^2)^{2N+1}}{\prod_{j=1}^N (w-c_j z^2)^2}$, see (1.9).

Claim 4. *The germ of the curve Γ_λ at the point $Q = [0 : 1 : 0] \in \mathbb{C}\mathbb{P}^2$ (i.e., at the intersection point of the infinity line with the w -axis) is irreducible, whenever $\lambda \neq 0, 1, \infty$. Its intersection index with each line through Q distinct from the infinity line $L_Q = T_Q\gamma$ is equal to $2N + 1$.*

Proof Let $\lambda \neq 0, 1, \infty$. In the affine chart $(\tilde{z}, \tilde{w}) = (\frac{z}{w}, \frac{1}{w})$ centered at Q one has

$$\Gamma_\lambda = \{(\tilde{w} - \tilde{z}^2)^{2N+1} - \lambda \tilde{w}^2 \prod_{j=1}^N (\tilde{w} - c_j \tilde{z}^2)^2 = 0\}.$$

In the coordinates (\tilde{z}, u) , $u := \tilde{w} - \tilde{z}^2$, Γ_λ is the zero locus of the polynomial

$$\mathcal{P}_\lambda(\tilde{z}, u) := u^{2N+1} - \lambda(u + \tilde{z}^2)^2 \prod_{j=1}^N (u + (1 - c_j)\tilde{z}^2)^2. \quad (2.3)$$

To prove irreducibility of the germ (Γ_λ, Q) , it suffices to show that the germ of the polynomial \mathcal{P}_λ at the origin is irreducible. To do this, we will deal with its Newton diagram. Namely, consider the bidegrees $(m, n) \in (\mathbb{R}_{\geq 0}^2)_{x,y}$ of all the monomials $\tilde{z}^m u^n$ entering \mathcal{P}_λ . Consider the convex hull of the union of the corresponding quadrants $(m, n) + \mathbb{R}_{\geq 0}^2$. The union \mathcal{ND} of its boundary edges except for the coordinate axes is called the *Newton diagram*. We claim that the Newton diagram of the polynomial \mathcal{P}_λ is one edge $E = [(4N + 4, 0), (0, 2N + 1)]$. Indeed, for $\lambda \neq 0, 1, \infty$ the bidegrees of the monomials entering \mathcal{P}_λ are $(0, 2N + 1)$ and a collection of points of the line $\{2y + x = 4N + 4\}$, since the multiplier at λ in (2.3) is a $(2, 1)$ -quasihomogeneous polynomial. But the bidegrees in the latter line lie above the edge E , except for its vertex $(4N + 4, 0)$. This proves that $\mathcal{ND} = E$.

Suppose the contrary: the germ of the polynomial \mathcal{P}_λ is not irreducible. Then it is the product of two germs of analytic functions with Newton diagrams being edges parallel to E whose endpoints lie in \mathbb{Z}^2 . The latter edges should be closer to the origin than E and have smaller lengths. But E is the edge of smallest length among all the above edges, since E contains no integer points in its interior: the numbers $4N + 4$ and $2N + 1$ are coprime. The contradiction thus obtained proves irreducibility of the germ of the polynomial \mathcal{P}_λ . The intersection index statement of Claim 4 follows from irreducibility, the Newton diagram statement $\mathcal{ND} = E$ and the fact that $T_Q\gamma = \{du = 0\} \subset T_Q\mathbb{C}\mathbb{P}^2$ (since $L_Q = \{\tilde{w} = 0\} = \{u + \tilde{z}^2 = 0\}$). \square

Let us prove irreducibility of the curve Γ_λ with $\lambda \neq 0$ small enough. Set $O = (0, 0)$. Fix two distinct points $P_1, P_2 \in \gamma^o := \gamma \setminus \{Q, O\}$, a path $\alpha \subset \gamma^o$ connecting them and a path

$\beta \subset \gamma \setminus \{O, P_2\}$ connecting P_1 to Q . Fix small neighborhoods $U_j = U_j(P_j) \subset \mathbb{C}\mathbb{P}^2$. The line P_1P_2 intersects Γ_λ with small $\lambda \neq 0$ at two subsets $\Sigma_j \subset U_j$, each consisting of $2N + 1$ points, by (2.3) and since $\deg \Gamma_\lambda = 4N + 2$. It suffices to show that the whole intersection $\Sigma_1 \cup \Sigma_2$ lies in one irreducible component of the curve Γ_λ . As $P_1 \rightarrow Q$ along the path β , Σ_2 remains in U_2 (if λ is small enough). Some $2N + 1$ points in Σ_1 should converge to Q , by the intersection index statement of Claim 4. But the set Σ_1 consists of exactly $2N + 1$ points, and hence, all its points converges to Q . (Modifying slightly the path β , one can achieve that the trajectories of points in Σ_1 going to Q avoid possible singularities of the curve Γ_λ .) Thus, Σ_1 lies in the irreducible component of the curve Γ_λ containing the germ (Γ_λ, Q) . Points of the set Σ_2 are connected to points in Σ_1 by paths close to α going along leaves of the foliation $R = \text{const}$, thus, along the regular part of the curve Γ_λ . (The latter paths define the holonomy map between neighborhoods of the points P_2, P_1 in the line P_1P_2 .) Hence, Σ_2 lies in the same irreducible component. This component has degree no less than the sum $4N + 2$ of cardinalities of the sets Σ_j , which is equal to $\deg \Gamma_\lambda$. Hence, the component in question is the whole curve Γ_λ , and thus, Γ_λ is irreducible.

Case of integral R given by (1.10) is treated analogously with the following modification: in the above coordinates (\tilde{z}, u) the Newton diagram of the new polynomial \mathcal{P}_λ is $[(2N + 3, 0), (0, N + 1)]$; $2N + 3, N + 1$ are again coprime.

The other canonical rational integrals have degrees 4 or 6 and the type

$$R(z, w) = \frac{(w - z^2)^m}{\Phi(z, w)}, \quad \Phi \text{ is a polynomial, } \deg \Phi = 2m, \quad m \in \{2, 3\}. \quad (2.4)$$

Proposition 2.9 *Let R be as in (2.4). Let there exist a sequence of values λ converging to zero for which the curve $\Gamma_\lambda := \{R = \lambda\}$ is not irreducible. Then the foliation $R = \text{const}$ is a pencil of conics.*

Proof Passing to a subsequence we can and will consider that one of the following statements holds for all above λ :

- (i) $m = 2$ and Γ_λ is a union of two regular conics $C_{1,\lambda}, C_{2,\lambda}$;
- (ii) Γ_λ contains a line;
- (iii) $m = 3$ and Γ_λ is a union of two regular cubics $C_{1,\lambda}, C_{2,\lambda}$;
- (iv) $m = 3$ and Γ_λ is a union of three regular conics.

Statement (ii) cannot hold: the contrary would imply that the limit conic $\Gamma_0 = \gamma = \{w = z^2\} = \lim_{\lambda \rightarrow 0} \Gamma_\lambda$ contains a line, which is not true. Suppose (iii) holds. Then each cubic considered as a divisor of degree three converges to an integer multiple of the divisor $[\gamma]$ of degree two: thus, to a divisor of even degree. This is obviously impossible. Therefore, the only possible cases are (i) and (iv). The a priori possible intersection points of the conics from (i), (iv) lie in the finite set of indeterminacy and critical points of the rational function R . Therefore, passing to a subsequence one can and will achieve that a family of conics $C_\lambda \subset \Gamma_\lambda$ lies in a pencil. The function R is constant on them for infinite number of values of λ . Therefore, it is constant on each conic of the pencil, since otherwise the set

of those parameters of the pencil for which $R = \text{const}$ on the corresponding conics is finite (being algebraic). Finally, the foliation $R = \text{const}$ is a pencil of conics. \square

Let R be a degree four integral given by (1.11) or (1.12). We treat only case (1.11), since the integrals (1.11) and (1.12) are obtained one from the other (up to constant factor) by complex projective transformation fixing the conic $\gamma = \{w = z^2\}$. Thus,

$$R = R_{b1}(z, w) = \frac{(w - z^2)^2}{(w + 3z^2)(z - 1)(z - w)}.$$

Suppose the contrary: the curve $\Gamma_\lambda := \{R = \lambda\}$ is not irreducible for a sequence of numbers λ converging to zero. Then the foliation $R = \text{const}$ is a pencil of conics, by Proposition 2.9. It contains the conics γ and $\{w + 3z^2 = 0\}$, which are tangent to each other at the origin and at infinity. Therefore, the pencil consists of conics tangent to them at these points. On the other hand, the line $\{z = 1\}$ lies in the polar locus $\{R = \infty\}$. Hence, it should lie in a conic from the pencil. But this is obviously impossible, – a contradiction.

Let now R be a degree 6 integral from the Addendum to Theorem 1.17, Cases 2c) or 2d). Supposing the contrary to irreducibility, we similarly get that the foliation $R = \text{const}$ is a pencil of conics. But in both Cases 2c) and 2d) the polar locus $\{R = \infty\}$ contains an irreducible cubic, see [30, subsections 7.5, 7.6]. This contradiction proves Statement 1) of Lemma 2.8.

Statement 2) of Lemma 2.8 follows from Statement 1) and the fact that γ is a multiplicity $\frac{d}{2}$ zero curve of the integral R .

Let us prove Statement 3). Suppose the contrary: there exists another leaf α of multiplicity $\frac{d}{2}$ and degree $\mu \geq 2$. Then for every given line L that is transversal to α and does not pass through singularities of the foliation each leaf close enough to α intersects L in at least $\mu \frac{d}{2} \geq d$ points. The number of intersection points cannot be greater than d . Hence, $\mu = 2$ and α is a conic. Let us renormalize the integral R by postcomposition with Möbius transformation ν to an integral $\tilde{R} = \nu \circ R$ so that $\tilde{R}|_\gamma = 0$, $\tilde{R}|_\alpha = \infty$. Let $Y(z, w)$ be a quadratic polynomial vanishing on α . Then

$$\tilde{R} = \left(\frac{w - z^2}{Y(z, w)} \right)^{\frac{d}{2}},$$

up to constant factor, by construction and multiplicity assumption. Therefore, the foliation $\tilde{R} = \text{const}$ is a pencil of conics containing γ and α , and so is $R = \text{const}$. But its generic leaves are punctured irreducible algebraic curves Γ_λ of degree $d \geq 4$. This contradiction proves Lemma 2.8. \square

Proof of Theorem 1.29. Consider a rationally integrable dual multibilliard with integral $\Psi \not\equiv \text{const}$. Then the dual billiard on each its curve γ_j is rationally integrable with integral Ψ . Hence, each γ_j is a conic equipped with either pencil type, or exotic dual billiard structure, by Theorem 1.17, and $\Psi|_{\gamma_j} \equiv \text{const}$, by [30, proposition 1.35] (or by Proposition 2.7).

Case 1). Let some two conics γ_1, γ_2 be the same conic γ equipped with two distinct dual billiard structures, given by projective involution families $\sigma_{P,j} : L_P \rightarrow L_P, j = 1, 2$. Here P lies outside a finite set: the union of the indeterminacy loci of families $\sigma_{P,j}$, which are finite by Theorem 1.17. The product $g_P := \sigma_{P,1} \circ \sigma_{P,2}$ is a parabolic transformation $L_P \rightarrow L_P$, having unique fixed point P for all but a discrete subset of points $P \in \gamma$ where $g_P = Id$. The integral Ψ is g_P -invariant: $\Psi \circ g_P = \Psi$ along each line L_P . But each non-fixed point of a parabolic transformation has infinite orbit. Therefore, $\Psi \equiv const$ along each line tangent to γ . But we know that Ψ is constant along the curve γ , as noted above. Therefore, $\Psi \equiv const$, by the two latter statements and since the union of lines tangent to γ at points lying in an open subset in γ contains an open subset in \mathbb{CP}^2 . The contradiction thus obtained proves that Case 1) is impossible.

Case 2): there are at least two geometrically distinct conics, say, γ_1, γ_2 . For every $j = 1, 2$ let R_j denote the canonical integral of the corresponding dual billiard structure. We have to prove the two following statements:

1) the dual billiard structure on each γ_j is defined by a pencil of conics, that is, the degree $d_j := \deg R_j$ is equal to 2;

2) the latter pencil is the same for $j = 1, 2$, and it contains both γ_j .

Let \mathcal{F} denote the foliation $\Psi = const$. For every j for all but a finite number of values $\lambda \in \mathbb{C}$ the complex level curve $\{R_j = \lambda\}$ is irreducible of degree d_j , by Lemma 2.8, and $\Psi \equiv const$ along it (Proposition 2.7). Hence, each foliation $R_j = const$ coincides with \mathcal{F} . This together with the previous statement implies that the degrees d_j are equal, set $d = d_j$, and both (punctured) conics γ_1, γ_2 are leaves of the same multiplicity $\frac{d}{2}$ for the foliation \mathcal{F} . Therefore, the foliation \mathcal{F} is a pencil of conics containing γ_1 and γ_2 , by Statement 3) of Lemma 2.8. Hence, all the conics of the multibilliard lie in this pencil, and $d = 2$ (since d is the degree of irreducible level curve of the function R_1). Thus, each R_j is a ratio of two quadratic polynomials, and its level curves are conics from the pencil. Therefore, it is an integral of the dual billiard structure on γ_j defined by the pencil. Hence, the initial dual billiard structure on γ_j is the same: given by the same pencil, see Case 1) treated above. Theorem 1.29 is proved. \square

Proof of Theorem 1.31. A rational first integral of a pencil type multibilliard is constant on each conic of the pencil (Proposition 2.7). Moreover, it is constant on every union of those conics whose parameter values λ lie in the same G -orbit. Here G is the group from Proposition 2.4. The cardinality of a generic G -orbit is equal to the cardinality $|G|$ of the group G , since a generic point in $\overline{\mathbb{C}}$ has trivial stabilizer in G . Thus, the minimal degree of the integral (which is achieved, by Proposition 2.5) is $2|G| \in \{2, 4, 12\}$. This together with Proposition 2.4 implies the statement of Theorem 1.31. \square

2.3 Dual billiard structures at vertices. Birationality and types of involutions

Proposition 2.10 *Let A be a point in \mathbb{RP}^2 (\mathbb{CP}^2) equipped with a real (complex) dual billiard structure given by involution family $\sigma_{A,\ell}$ that has a real (complex) rational first*

integral $\Psi \neq \text{const}$: $\Psi \circ \sigma_{A,\ell} = \Psi$ on each line ℓ through A on which the involution is defined. Let the foliation $\Psi = \text{const}$ be not the family of lines through A . Then $\sigma_{A,\ell}$ coincide (up to correction at a finite number of lines ℓ) with a birational involution $\sigma_A : \mathbb{CP}^2 \rightarrow \mathbb{CP}^2$ fixing all but a finite number of lines through A and holomorphic and bijective on the complement to a finite number of lines through A . (Thus, it is a de Jonquières involution, see Footnote 3 and [14, p.422].) Moreover, along all but a finite number of lines ℓ through A it is a projective involution $\ell \rightarrow \ell$ fixing A . The rational integral Ψ and the corresponding foliation $\Psi = \text{const}$ are σ_A -invariant⁵

Proof Let $\sigma_{A,\ell} : \ell \rightarrow \ell$ be the corresponding projective involution family acting on lines ℓ through A . They are defined on lines ℓ through A from an open subset $U \in \mathbb{CP}^1$ in complex case ($U \subset \mathbb{RP}^1$ in real case).

Fix a nonlinear complex level curve $X := \{\Psi = \lambda\}$. Fix an $\ell_0 \in U$ (consider it as a complex line) such that the points of intersection $X \cap \ell_0$ distinct from A are regular points of the curve X , the intersections are transversal, and the multiplicity of the intersection $X \cap \ell_0$ at A is minimal. There exists a simply connected neighborhood $V = V(\ell_0) \subset \mathbb{CP}^1$ such that for every $\ell \in V$ the number of geometrically distinct points of the set $X_\ell := (X \cap \ell) \setminus \{A\} \subset \mathbb{CP}^2$ is the same (let us denote their number by d), and they depend holomorphically on ℓ (Implicit Function Theorem). We numerate these holomorphic intersection point families by indices $1, \dots, d$. For every $\ell \in V$ the involution $\sigma_{A,\ell}$ makes a (ℓ -dependent) permutation of the latter intersection points, which is identified with a permutation of indices $1, \dots, d$: an element in S_d . There exists a permutation $\alpha \in S_d$ realized by $\sigma_{A,\ell}$ for a continuum cardinality subset $Y \subset V$ of lines. Let us fix it.

Claim 6. *There exists a projective involution family $\tilde{\sigma}_{A,\ell} : \ell \rightarrow \ell$ depending holomorphically on the parameter $\ell \in V$ that makes the permutation α on X_ℓ for every $\ell \in V$. The rational function $\Psi|_\ell$ is $\tilde{\sigma}_{A,\ell}$ -invariant: $\Psi \circ \tilde{\sigma}_{A,\ell} = \Psi$ on every $\ell \in V$.*

Proof Consider first the case, when X_ℓ is just one point. For every $\ell \in V$ set $\tilde{\sigma}_{A,\ell} : \ell \rightarrow \ell$ to be the non-trivial conformal involution fixing the points X_ℓ and A . It depends holomorphically on $\ell \in V$. It preserves $\Psi|_\ell$: $\Psi \circ \tilde{\sigma}_{A,\ell} = \Psi$ on every $\ell \in Y$, since $\tilde{\sigma}_{A,\ell} = \sigma_{A,\ell}$; the two latter relations hold for every $\ell \in V$, since Y is of cardinality continuum and by uniqueness of analytic extension.

Let now X_ℓ consist of at least two points. Let us define $\tilde{\sigma}_{A,\ell}$ to be the unique projective transformation $\ell \rightarrow \ell$ fixing A and sending the points in X_ℓ with indices 1, 2 to the points with indices $\alpha(1), \alpha(2)$ respectively. For every $\ell \in V$ this is an involution preserving $\Psi|_\ell$, since this is true for every $\ell \in Y$ and by uniqueness of analytic extension. The claim is proved. \square

⁵Invariance of a rational function Ψ under a birational transformation $\sigma : \mathbb{CP}^2 \rightarrow \mathbb{CP}^2$ means that $\Psi \circ \sigma = \Psi$ on the open and dense subset where both Ψ and $\Psi \circ \sigma$ are well-defined. Let σ be a de Jonquières involution σ_A fixing all but a finite number of lines through A . Let its restriction to a generic line through A be a projective involution fixing A . In this case if Ψ is σ_A -invariant, then the σ_A -image (strict transform) of each level curve $\Gamma_\lambda = \{\Psi = \lambda\}$ coincides with Γ_λ except for the following case: if Γ_λ contains some lines through A , then σ_A may contract some of its lines to A , and its other irreducible components (if any) are permuted by σ_A .

Claim 7. *The involution family $\tilde{\sigma}_{A,\ell}$ extends holomorphically to a finitely punctured space \mathbb{CP}^1 of lines through A . It coincides with $\sigma_{A,\ell}$ on all the lines $\ell \in U$ except maybe for a finite number of them, on which $\Psi = \text{const}$.*

Proof We can extend the involution family $\tilde{\sigma}_{A,\ell}$ analytically in the parameter ℓ along each path avoiding a finite number of lines ℓ for which either some of the points in X_ℓ are not transversal intersections, or the index of intersection $\ell \cap X$ at A is not the minimal possible. This follows from the previous claim and its proof. Extension along a closed path does not change holomorphic branch. Indeed, otherwise there would exist its another holomorphic branch over a domain $W \subset V$: an involution family $H_{A,\ell} : \ell \rightarrow \ell$ depending holomorphically on $\ell \in W$, $H_{A,\ell} \neq \tilde{\sigma}_{A,\ell}$, which preserves the integral Ψ . The product $F_\ell := \tilde{\sigma}_{A,\ell} \circ H_{A,\ell} : \ell \rightarrow \ell$ is a parabolic projective transformation, with A being its unique fixed point, for every $\ell \in W$. Its orbits are infinite, and Ψ should be constant along each of them. This implies that $\Psi = \text{const}$ along each line $\ell \in W$. Hence, the foliation $\Psi = \text{const}$ is the family of lines through A , which is forbidden by our assumption. The contradiction thus obtained proves singlevaluedness of analytic extensions of the involution family $\tilde{\sigma}_{A,\ell}$ along paths and the first statement of the claim. Its second statement follows from the fact that for those $\ell \in U$ for which $\tilde{\sigma}_{A,\ell} \neq \sigma_{A,\ell}$, one has $\Psi \equiv \text{const}$ along ℓ : see the above argument, now with the parabolic transformation $\tilde{\sigma}_{A,\ell} \circ \sigma_{A,\ell}$. The claim is proved. \square

Without loss of generality we consider that $\sigma_{A,\ell} = \tilde{\sigma}_{A,\ell}$, correcting $\sigma_{A,\ell}$ at a finite number of lines. The latter equality defines analytic extension of the involution family $\sigma_{A,\ell}$ to all but a finite number of lines ℓ through A . The invariance condition $\Psi \circ \sigma|_\ell = \Psi|_\ell$ is a system of algebraic equations on the pairs (ℓ, σ) , where ℓ is a projective line through A and $\sigma : \ell \rightarrow \ell$ is a non-trivial projective involution fixing A . For every line ℓ through A (except for a finite set of lines, along which $\Psi \equiv \text{const}$) its solution σ is at most unique, by the above argument. This implies that the family $\sigma_{A,\ell}$ is a connected open subset in an algebraic subset of a smooth algebraic manifold and all $\sigma_{A,\ell}$ paste together to a global birational automorphism $\mathbb{CP}^2 \rightarrow \mathbb{CP}^2$ acting as a holomorphic involution on the complement to a finite number of lines through A . It preserves Ψ , and hence, the foliation $\Psi = \text{const}$, by construction. Proposition 2.10 is proved. \square

Lemma 2.11 *The dual billiard structure at each vertex A of any rationally integrable dual multibilliard is either global, or quasi-global. In the case of quasi-global structure the foliation by level curves of rational integral is a pencil of conics, and the conic of fixed points of the corresponding involution σ_A lies in the same pencil.*

Proof Consider first the case, when the foliation by level curves of integral is a pencil of conics. It is invariant under the birational involution σ_A from Proposition 2.10. Thus, the involution σ_A permutes conics of the pencil (except for at most a finite number of singular conics containing some lines through A , see Footnote 3). Therefore, σ_A acts on parameter space $\overline{\mathbb{C}}$ of the pencil as a conformal involution with at least two fixed points (by Erasing Singularity Theorem). Thus, σ_A fixes pencil parameters of at least two distinct conics of the pencil. Fix one of them that is not a pair of lines intersecting at A , let us denote it by

Γ . It is possible, since a pencil cannot contain two singular conics, each of them being a pair of lines, so that all the four lines forming them pass through the same point A . Indeed, otherwise A would be the unique base point of the pencil, and the pencil would have type e). Thus, its only singular conic would be the double line tangent to all its regular conics at A , – a contradiction.

Subcase 1.1): Γ is disjoint from A . Then σ_A is a projective angular symmetry, by Example 1.22.

Subcase 1.2): Γ passes through A . If Γ is a union of lines, then some of its lines, let us denote it by L , does not pass through A . Then σ_A is the projective involution that fixes each point of the line L , by definition. Similarly, if Γ is a regular conic, then σ_A fixes each its point. Hence, it defines a quasi-global dual billiard structure.

Consider now the case of exotic rationally integrable multibilliard, when the foliation by level curves of the integral is not a pencil. Then the multibilliard contains just one conic, let us denote it by γ , equipped with an exotic dual billiard structure, and maybe some vertices.

Proposition 2.12 *In the above exotic multibilliard for every its vertex A the corresponding involution σ_A is a projective angular symmetry.*

Proof Let R be the canonical integral of the exotic dual billiard structure on the conic of the multibilliard, $d = \deg R$. Let Ψ be a rational integral of the multibilliard. The foliation $\Psi = \text{const}$ coincides with $R = \text{const}$, by Proposition 2.7. The (punctured) curve γ being a leaf of multiplicity $\frac{d}{2}$, its (punctured) image $\gamma' := \sigma_A(\gamma)$ is also a multiplicity $\frac{d}{2}$ leaf, since $\Psi \circ \sigma_A = \Psi$ and multiplicity is invariant under birational automorphism of foliation. Hence, $\gamma' = \gamma$, if γ' is not a line (Lemma 2.8, Statement 3)).

Subcase 2.1): $A \notin \gamma$. Then a generic line through A intersects γ at two points distinct from A . Hence, the same holds for the image γ' . Thus, it is not a line, and $\sigma_A(\gamma) = \gamma$. Therefore, σ_A is a global projective transformation, the γ -angular symmetry.

Subcase 2.2): $A \in \gamma$ and $\gamma' \neq \gamma$. Let us show that this case is impossible. Indeed, then γ' is a line, see the above discussion, and $R|_{\gamma'} \equiv \text{const} \neq 0$. Therefore, the points of intersection $\gamma' \cap \gamma$ are indeterminacy points for the function R . In Case 2a) the only indeterminacy points are the origin O and the infinity. Therefore, γ' is some of the following lines: the Ow -axis (which passes through both latter points), the Oz -axis or the infinity line (which are tangent to γ at O and at infinity respectively). But each of the latter lines satisfies at least one of the following statements:

- either R is non-constant there;
- or R has a pole of multiplicity less than $\frac{d}{2}$ there.

See the two first formulas for the integrals in the addendum to Theorem 1.17. Therefore, the (punctured) line γ' cannot be a multiplicity $\frac{d}{2}$ leaf of the foliation $R = \text{const}$. This contradiction proves that the case under consideration is impossible. Cases 2b), 2c), 2d) are treated analogously.

Subcase 2.3): $A \in \gamma = \sigma_A(\gamma)$. Therefore, for every line ℓ through A distinct from the line L tangent to γ at A the involution σ_A fixes the point of intersection $\ell \cap \gamma$ distinct from A . Thus, it is the degenerate γ -angular symmetry. In the chart (x, y) where $\gamma = \{y = x^2\}$,

A is the point of the parabola γ at infinity, and L is the infinity line, σ_A acts as

$$\sigma_A : (x, y) \mapsto (x, 2x^2 - y).$$

In the coordinates (x, y) one has

$$R = R(x, y) = \frac{(y - x^2)^m}{F(x, y)}, \quad F(x, y) \text{ is a polynomial, } \deg F \leq 2m. \quad (2.5)$$

To treat the case in question, we use the following claim.

Claim 8. *The point A is an indeterminacy point of the function R .*

Proof Let us first consider the case, when L lies in a level curve $S_{\lambda_0} := \{R = \lambda_0\}$. Then $\lambda_0 \neq 0$, since $S_0 = \gamma$. Thus, A lies in two distinct level curves, and hence, is an indeterminacy point. Let us now suppose that $R|_L \not\equiv \text{const}$. As a line ℓ through A tends to the tangent line L to γ , its only intersection point $B(\ell)$ with γ distinct from A tends to A . Therefore, the involution $(\sigma_A)|_\ell$, which fixes the confluent points A and $B(\ell)$, tends to the constant map $L \rightarrow A$ uniformly on compact subsets in $L \setminus \{A\}$. Suppose the contrary: A is not an indeterminacy point. Fix a generic $\lambda \neq 0$, for which $S_\lambda = \{R = \lambda\}$ is irreducible (see Lemma 2.8, Statement 1)). Its image (strict transform) $S_{\lambda'} := \sigma_A(S_\lambda)$ is an irreducible component of a level curve $\{R = \lambda'\}$, $\lambda' \neq 0$. Hence, $A \notin S_\lambda, S_{\lambda'}$, since $A \in S_0$. Therefore, the points of intersections $\ell \cap S_\lambda$ do not accumulate to A , as $\ell \rightarrow L$. Hence, the points in $\sigma_A(\ell \cap S_\lambda) \subset S_{\lambda'}$ converge to A , and thus, $A \in S_{\lambda'}$. This contradiction proves the claim. \square

Claim 9. *Let F be the same, as in (2.5). Then*

$$F \circ \sigma_A(x, y) = (-1)^{m+1} F(x, y) + a(y - x^2)^m, \quad a = \text{const} \in \mathbb{C}. \quad (2.6)$$

Proof The involution σ_A is birational, and it permutes leaves of the foliation $R = \text{const}$ (except for possible contraction of leaves that are (punctured) lines through A , see Footnote 3). All but a finite number of leaves are punctured level curves of the function R , since all but a finite number of level curves are irreducible (Lemma 2.8). Therefore σ_A permutes level curves of the function R (except for at most a finite number of non-irreducible level curves and those containing lines through A). Hence, it acts on its values by conformal involution $\overline{\mathbb{C}} \rightarrow \overline{\mathbb{C}}$ (by Erasing Singularity Theorem). The latter involution preserves zero, which corresponds to the σ_A -invariant curve γ . Hence, its action on values of the function $\frac{1}{R}$ is either identity, or an affine involution $\mu \mapsto -\mu + b$, $b = \text{const}$. This together with the fact that σ_A changes sign of the polynomial $y - x^2$ implies the statement of the claim with $a = (-1)^m b$. \square

We consider the rational integrals R from the addendum to Theorem 1.17, all their indeterminacy points A and the corresponding involutions σ_A fixing points of γ : degenerate γ -angular symmetries. For every pair (R, A) , assuming σ_A -invariance of the foliation $R = \text{const}$, we will arrive to contradiction. This will prove Proposition 2.12.

Everywhere below by F we denote the denominator of the rational function R (written in the coordinates (z, w) or (x, y) under consideration).

2a1) The integral R given by (1.9). Let A be the infinity point of the parabola $\gamma = \{w = z^2\}$. Then $\sigma_A(z, w) = (z, 2z^2 - w)$. The functions R and $R \circ \sigma_A$ have the same foliation by level curves. Therefore, their ratio, which is equal to $\pm \frac{F \circ \sigma_A}{F}$, is constant along each leaf. But the latter ratio is constant on the w -axis, since the coordinate z is σ_A -invariant, the polynomial F contains a unique purely w -term w^k , and this remains valid for its pullback $F \circ \sigma_A$ with the same k . On the other hand, the w -axis is not a leaf, since $R(0, w) = w^2$. Thus, the above ratio is globally constant,

$$F \circ \sigma_A = F \text{ up to constant factor.} \quad (2.7)$$

But $F(z, w) = \prod_{j=1}^N (w - c_j z^2)^2$, $F \circ \sigma_A(z, w) = \prod (w - (2 - c_j)z^2)^2$, the coefficients c_j in F are negative, see (1.9), while the latter coefficients $2 - c_j$ are positive. Therefore, equality (2.7) cannot hold, – a contradiction.

Let $A = O = (0, 0)$. Consider the chart $(x, y) = (\frac{z}{w}, \frac{1}{w})$, in which $A = \infty$,

$$R(x, y) = \frac{(y - x^2)^{2N+1}}{F(x, y)}, \quad F(x, y) = y^2 \prod_{j=1}^N (y - c_j x^2)^2, \quad c_j < 0.$$

Equality (2.7) is proved analogously. The coefficients c_j at x^2 in F are negative. But $F \circ \sigma_A(x, y) = (y - 2x^2)^2 \prod (y - (2 - c_j)x^2)^2$, and the coefficients $2, 2 - c_j$ at x^2 are positive there. Hence, equality (2.7) cannot hold, – a contradiction.

2a2) Case of integral (1.10). Treated analogously to the above case. But now $R \equiv \infty$ along the w -axis, and the above argument does not work as it is. In this case we replace the w -axis in the above argument by a parabola $\Gamma_\eta := \{w = \eta z^2\}$ with a generic $\eta \neq 0$. One has $\frac{F \circ \sigma_A}{F}|_{\Gamma_\eta} \equiv \text{const}$, which follows by substitution $w = \eta z^2$. On the other hand, $R|_{\Gamma_\eta} \equiv cz$, $c = c(\eta) \neq 0$ for a generic η . Afterwards repeating the above argument we get (2.7) and arrive to contradiction as above.

Cases 2b1) and 2b2) have the same complexification; thus we treat only Case 2b2), when the integral R is given by (1.12). There are three indeterminacy points: the infinity and $(\pm i, -1)$. Let $A \in \gamma$ be the infinite point, hence $\sigma_A(z, w) = (z, 2z^2 - w)$. The denominator F is the product of the σ_A -invariant quadratic polynomial $z^2 + 1$ and another quadratic polynomial $\Phi(z, w) = z^2 + w^2 + w + 1$. Therefore, the polynomial $F \circ \sigma_A$ is divisible by $z^2 + 1$, and hence is equal to $\pm F$, by (2.6). This implies that $\Phi \circ \sigma_A = \pm \Phi$ is a quadratic polynomial, while it has obviously degree four, – a contradiction. Let now $A = (\pm i, -1)$. Let B denote the infinite point of the parabola γ . Let us choose an affine chart (x, y) centered at B so that its complement (i.e., the corresponding infinity line) is the line tangent to γ at A , the y -axis is the line $\{z = z(A)\}$, and $\gamma = \{y = x^2\}$. In the new coordinates one has $\sigma_A(x, y) = (x, 2x^2 - y)$, $R(x, y) = \frac{(y - x^2)^2}{x\Phi(x, y)}$, where Φ is a cubic polynomial coprime with $y - x^2$. Analogously we get that $\Phi \circ \sigma_A = \pm \Phi$. If Φ contains a monomial divisible by y^2 , then $\deg(\Phi \circ \sigma_A) \geq 4$, and we get a contradiction. Otherwise $\Phi(x, y) = c(y + \Psi(x))$, where Ψ is a polynomial; Φ is coprime with $y - x^2$, hence, $\Psi(x) \neq -x^2$. But then $\Phi \circ \sigma_A \neq \pm \Phi$, – a contradiction.

Cases 2c1) and 2c2). Note that the integral R from 2c1) is invariant under the order 3 group generated by the symmetry $(z, w) \mapsto (\varepsilon z, \varepsilon^2 w)$, where ε is a cubic root of unity. This group acts transitively on the set of three indeterminacy points. Thus, it suffices to treat the case of just one indeterminacy point A . Again it suffices to treat only Case 2c2), which has the same complexification, as Case 2c1), with A being the infinite point of the parabola γ . To do this, let us first recall that the $(2, 1)$ -quasihomogeneous degree of a monomial $z^m w^n$ is the number $m + 2n$. A polynomial is $(2, 1)$ -quasihomogeneous, if all its monomials have the same $(2, 1)$ -quasihomogeneous degree. Each polynomial in two variables is uniquely presented as a finite sum of $(2, 1)$ -quasihomogeneous polynomials of distinct quasihomogeneous degrees. The indeterminacy points of the integral R given by (1.14) are $O = (0, 0)$, $(1, 1)$ and the infinity point of the parabola γ .

Taking composition with $\sigma_A(z, w) = (z, 2z^2 - w)$ preserves the quasihomogeneous degrees. The lower quasihomogeneous part of the denominator F in (1.14) is the polynomial $(w + 8z^2)^2$ of quasihomogeneous degree 4. Therefore, the lower quasihomogeneous part of the polynomial $F \circ \sigma_A$ is the polynomial $(w - 10z^2)^2 \neq \pm(w + 8z^2)^2$. The numerator $(w - z^2)^3$ is quasihomogeneous of degree 6. The two latter statements together imply that formula (2.6) cannot hold, – a contradiction.

Case 2d). Then we have three indeterminacy points: the origin, the infinity point and the point $(1, 1)$. The case, when A is the infinity point of the parabola γ , is treated analogously to Case 2b2). Let us consider the case, when A is the origin. In the coordinates $(x, y) = (\frac{z}{w}, \frac{1}{w})$ one has $\sigma_A(x, y) = (x, 2x^2 - y)$, and the function R takes the form $R(x, y) = \frac{(y - x^2)^3}{F(x, y)}$,

$$F(x, y) = (y + 8x^2)(x - y)(y^2 + 8x^2y + 4y + 5x^2 - 14xy - 4x^3).$$

The lower $(2, 1)$ -quasihomogeneous part of the polynomial F is $V(x, y) := x(y + 8x^2)(4y + 5x^2)$. It has quasihomogeneous degree 5, while the numerator in R has quasihomogeneous degree 6. This together with (2.6) implies that σ_A multiplies the lower quasihomogeneous part by ± 1 . But $V \circ \sigma_A(x, y) = x(y - 10x^2)(4y - 13x^2) \neq \pm V(x, y)$, – a contradiction.

Let us now consider the case, when $A = (1, 1)$. Take the affine coordinates (x, y) centered at the infinite point of the parabola γ such that the complement to the affine chart (x, y) is the tangent line L to γ at A , the y -axis is the zero line $\{z = 1\}$ of the denominator (which passes through A), and $\gamma = \{y = x^2\}$. The rational function R takes the form

$$R(x, y) = \frac{(y - x^2)^3}{F(x, y)}, \quad F(x, y) = xG_2(x, y)G_3(x, y), \quad G_j(0, y) \neq 0, \quad \deg G_j = j.$$

In the chart (x, y) one has $\sigma_A(x, y) = (x, 2x^2 - y)$. The factor x in F is σ_A -invariant. Therefore, $F \circ \sigma_A = \pm F$, by (2.6), and σ_A leaves invariant the zero locus $Z = \{G_2 G_3 = 0\}$. The latter zero locus is a union of the conic $\{G_2 = 0\}$ disjoint from A and a cubic $\{G_3 = 0\}$. The latter cubic intersects a generic line ℓ through A at a unique point distinct from A , since it has a cusp at A , see [30, subsection 7.6, claim 9]. Thus, for a generic line ℓ through A , the intersection $Z \cap (\ell \setminus \{A\})$ consists of three distinct points disjoint from γ , and it is invariant under the involution σ_A . This implies that one of them is fixed (let us denote

it by B). Hence, for a generic ℓ the projective involution $(\sigma_A)|_\ell$ has three distinct fixed points: A , B and the unique point of the intersection $\gamma \cap (\ell \setminus \{A\})$. Thus, it is identity, – a contradiction. Proposition 2.12 is proved. \square

Proposition 2.12 together with the discussion before it imply Lemma 2.11. \square

2.4 Pencil case. Proof of Theorem 1.30

We already know that if a dual multibilliard is of pencil type, then it is rationally integrable (Proposition 2.5). Consider now an arbitrary rationally integrable dual multibilliard where all the curves are conics equipped with a dual billiard structure defined by the same pencil (containing each conic of the multibilliard). Let us show that the multibilliard is of pencil type, that is, its vertices (if any) are admissible, i.e., belong to the list given by Definition 1.25, and their collection satisfies the conditions of Definition 1.27.

Proposition 2.13 *Let a rationally integrable multibilliard consist of conics lying in a pencil, equipped with dual billiard structures defined by the same pencil, and some vertices. Then each its vertex is admissible for the pencil.*

Proof Let Ψ be a rational integral of the multibilliard, $\Psi \neq \text{const}$. The foliation $\Psi = \text{const}$ coincides with the pencil under consideration, by Proposition 2.7. Let K be a vertex of the multibilliard. Then its dual billiard structure is given by an involution $\sigma_K : \mathbb{CP}^2 \rightarrow \mathbb{CP}^2$ preserving the pencil that is either a global projective involution, or a degenerate angular symmetry: an involution fixing points of a regular conic α passing through K and lying in the pencil (Lemma 2.11).

Let us first treat the second case, when σ_K fixes points of a regular conic α from the pencil, $K \in \alpha$. Let L denote the tangent line to α at K . Consider the affine chart (z, w) on the complement $\mathbb{CP}^2 \setminus L$ in which $\alpha = \{w = z^2\}$; the point K is the intersection of the infinity line with the w -axis. One has $\sigma_K(z, w) = (z, 2z^2 - w)$. Each regular conic β of the pencil is given by a quadratic equation $\{w + \Phi_2(z) = 0\}$, where Φ_2 is a quadratic polynomial. Indeed, the quadratic equation on β contains neither w^2 , nor wz terms, since σ_K transforms them to polynomials of degrees four and three respectively, while it should send β to a conic of the pencil. This implies that all the regular conics of the pencil are tangent to each other at K , and we get that K is an admissible vertex from Definition 1.25.

Let us now treat the first case, when σ_K is a global projective involution.

Claim 10. *Let K be not a base point of the pencil, and let σ_K be a global projective involution. Then the conic \mathcal{S} through K is a pair of lines.*

Proof The conic \mathcal{S} is fixed by σ_K , as is K . If it were regular, then it would intersect a generic line ℓ through K at a point distinct from K , and the involution σ_K would fix each point in \mathcal{S} . Thus, it would be a degenerate \mathcal{S} -angular symmetry, not a projective transformation, – a contradiction. \square

Subcase 1): K is not a base point of the pencil, and the conic \mathcal{S} through K is a pair of distinct lines L_1, L_2 , both passing through K . In the case, when the pencil consists of conics

passing through four distinct base points, there are two base points V_{j1}, V_{j2} in each line L_j . Therefore, K is a standard vertex M_s from Definition 1.25, and the projective involution σ_K permutes V_{j1}, V_{j2} for every $j = 1, 2$. Hence, σ_K coincides with the involution σ_{M_s} from Definition 1.25, Case a). In the case, when the pencil has three distinct base points, two of them lie in one of the lines, say L_1 , the third one (denoted by C) lies in L_2 , and L_2 is tangent at C to all the regular conics of the pencil. We get analogously that $K = M$ and $\sigma_K = \sigma_M$, see Definition 1.25, Case b). Case c), when the conics of the pencil are tangent to each other at two base points, is treated analogously. Case e) is impossible, since then the pencil contains no distinct line pair. In Case d) it contains the unique pair of distinct lines. They intersect at a base point: the common tangency point of conics. Hence, this case is impossible.

Subcase 2): K is not a base point, the conic \mathcal{S} consists of a line L_1 through K and a line L_2 that does not pass through K . Then σ_K fixes K and each point of the line L_2 , and hence, the intersection point $M = L_1 \cap L_2$. In Case a) there are two base points in each line L_j . Those lying in L_1 should be permuted by σ_K . Therefore, the points K, M and the two base points in L_1 form a harmonic quadruple. Hence K is one of the skew vertices from Definition 1.25, Case a). In Case b) there are three distinct base points. The case, when two of them lie in L_1 , is treated as above: then $K = K_{AB}$, see Definition 1.25, b2). In the case, when L_1 contains only one base point C , it should be fixed by σ_K , as is M . Therefore, $C = M$, since the projective involution $(\sigma_K)|_{L_1}$ cannot have three distinct fixed points C, M, K . Finally, all the three base points are contained in the line L_2 , which is obviously impossible. Similarly in Case c) we get that \mathcal{S} is the union of tangent lines L_A, L_C to the conics of the pencil at its base points A, C , and K lies in one of these lines, say L_A , and $K \neq Q := L_A \cap L_C$. Then σ_K would fix three distinct points K, A, Q of the line L_A , hence $\sigma_K = Id$ on L_A . The contradiction thus obtained shows that this subcase is impossible.

In Case d) (conics tangent at a point A with triple contact and passing through another point B) the point K should lie in the line L tangent to the conics at A . (This realizes the vertex C from Subcase d2) in Definition 1.25.) Indeed, otherwise K would lie in $AB \setminus \{A, B\}$, and the involution σ_K would fix three distinct points $A, B, K \in AB$, – a contradiction. Case e) is impossible, since then the pencil contains no distinct line pair.

Subcase 3): K is not a base point, and the conic \mathcal{S} is a double line L through K . Then
- either the pencil is of type c) and L passes through the two base points; the involution σ_K should permute them and the tangent lines at them to the conics of the pencil; we get $K = M'$, see Definition 1.25, c1);

- or the pencil is of type e) and L is tangent to its regular conics at the unique base point; the involution should fix K and those points where the tangent lines to conics pass through K ; the latter points form a line through the base point; we get $K = C$, see Definition 1.25, e2).

Subcase 4): K is a base point. Then each line L passing through K and another base point A contains no more base points. Thus, the involution $(\sigma_K)|_L$ should fix both K and A . Finally, σ_K fixes each base point. Therefore, the base points different from K lie on the fixed point line Λ of the projective involution σ_K . Let the pencil be of type a). Then

Λ contains three base points, – a contradiction. Let now the pencil have type b). Then Λ contains two base points. Hence, they are points of transversal intersection with Λ of a generic conic of the pencil. Thus, its conics are tangent to each other at K , and the vertex K has type b3) from Definition 1.25. Case of pencil of type c) is treated analogously: K is a vertex of type c2).

Consider the case of pencil of type d). Let K be the base point B of transversal intersection of conics. Then the involution σ_K , which preserves the pencil, should fix K and each point of the common tangent line L to the conics at the other base point A . Thus, $\Lambda = L$. In an affine chart (z, w) centered at A , in which B is the intersection point of the infinity line with the Ow -axis and L is the z -axis, the involution σ_K is the symmetry with respect to the z -axis. The latter symmetry changes the 2-jet of a regular conic of the pencil at A . But its conics should have the same 2nd jet at A . Hence, σ_K cannot preserve the pencil, – a contradiction. Therefore, $K = A, B \in \Lambda$. Let us choose an affine chart (z, w) centered at B for which L is the infinity line, K is its intersection with the Ow -axis, and Λ is the z -axis. Then σ_K is again the symmetry as above, and it changes 2nd jets of conics (which are parabolas) at their infinity point K . Therefore, Case d) is impossible. Case e) is treated analogously.

Finally, all the possible vertices listed above belong to the list of admissible vertices from Definition 1.25. Proposition 2.13 is proved. \square

The rational integral of the multibilliard is constant on each union of conics of the pencil whose parameter values form a G -orbit, and the double cardinality $2|G|$ is no greater than the degree of the integral: see the proof of Theorem 1.31 at the end of Subsection 2.2. Therefore, G is finite. Hence, the multibilliard is of pencil type, by Proposition 2.4. Theorem 1.30 is proved.

2.5 Exotic multibilliards. Proof of Theorem 1.35

Proposition 2.14 *Each multibilliard consisting of one conic equipped with an exotic dual billiard structure (see Theorem 1.17) and arbitrary collection of corresponding admissible vertices (see Theorem 1.35) is rationally integrable. The corresponding rational function R from the addendum to Theorem 1.17 is its integral of minimal degree, except for the subcase in Case (i), when $\rho = 2 - \frac{1}{N+1}$; in this subcase R^2 is a first integral of minimal degree.*

Proof If there are no vertices (which holds, e.g., in Case 2d)), then rational integrability follows by Theorem 1.17. Let now the multibilliard contain at least one admissible vertex.

Case (i). The function R (respectively, R^2) is a rational integral of minimal degree, since R is even (odd) in z .

Case (ii) is treated analogously to Case (i). It suffices to treat the subcase 2b2), since the multibilliards of types 2b1), 2b2) containing the unique admissible vertex are projectively isomorphic (Proposition 1.36). In subcase 2b2) the function R is even in z , and hence, invariant under the corresponding admissible vertex involution $(z, w) \mapsto (-z, w)$.

Case (iii). Let us show that the γ -angular symmetry σ_Q centered at each admissible vertex Q preserves the integral R . Cases 2c1) and 2c2) being complex-projectively iso-

morphic and invariant under order three symmetry cyclically permuting the three singular points, we treat Case 2c2), with $Q = (0, -1)$ being the intersection point of the w -axis (i.e., the line through two indeterminacy points: O and ∞) and the line tangent to γ at the indeterminacy point $(1, 1)$. We use the following two claims and proposition.

Claim 11. *The polar locus*

$$S := \{P(z, w) = 8z^3 - 8z^2w - 8z^2 - w^2 - w + 10zw = 0\}$$

passes through $Q = (0, -1)$ and has an inflection point there.

Proof One has $Q = (0, -1) \in S$ (straightforward calculation). To show that Q is an inflection point, it suffices to show that $\nabla P(Q) \neq 0$ and the Hessian form of the function P evaluated on the skew gradient $(\frac{\partial P}{\partial w}, -\frac{\partial P}{\partial z})$ (which is a function of Q denoted by $H(P)(Q)$) vanishes at Q . (The latter Hessian form function $H(P)$ was introduced in [40].) Indeed,

$$\frac{\partial P}{\partial z}(Q) = -10, \quad \frac{\partial P}{\partial w}(Q) = 2 - 1 = 1,$$

$$\frac{\partial^2 P}{\partial z^2}(Q) = 0, \quad \frac{\partial^2 P}{\partial w^2}(Q) = -2, \quad \frac{\partial^2 P}{\partial z \partial w}(Q) = 10,$$

$$H(P) = \frac{\partial^2 P}{\partial z^2} \left(\frac{\partial P}{\partial w} \right)^2 + \frac{\partial^2 P}{\partial w^2} \left(\frac{\partial P}{\partial z} \right)^2 - 2 \frac{\partial^2 P}{\partial z \partial w} \frac{\partial P}{\partial w} \frac{\partial P}{\partial z} = 0 - 200 + 200 = 0$$

at the point Q . The claim is proved. \square

Proposition 2.15 *Let a cubic $S \subset \mathbb{CP}^2$ have an inflection point Q . Then there exists a projective involution $\sigma_{Q,S} : \mathbb{CP}^2 \rightarrow \mathbb{CP}^2$ that fixes each line through Q and permutes its intersection points with S distinct from Q (for ℓ being not the tangent line to S at Q).*

Proof The above involution is well-defined on each line ℓ through Q distinct from the tangent line Λ to S at Q as a projective involution $\sigma_{Q,S,\ell} : \ell \rightarrow \ell$ depending holomorphically on $\ell \neq \Lambda$. It suffices to show that the involution family thus obtained extends holomorphically to $\ell = \Lambda$. This will imply that $\sigma_{Q,S}$ is a well-defined global holomorphic involution $\mathbb{CP}^2 \rightarrow \mathbb{CP}^2$, and hence, a projective transformation. Indeed, let us take an affine chart (x, y) centered at Q and adapted to S , so that Λ is the Ox -axis and the germ of the cubic S is the graph of a germ of holomorphic function:

$$y = f(x), \quad f(x) = ax^3 + (b + o(1))x^4; \quad S = \{y = f(x)\}.$$

A line $\ell_\delta := \{y = \delta x\}$ with small slope δ intersects S at two points distinct from $Q = (0, 0)$ with x -coordinates x_0, x_1 satisfying the equation

$$\frac{f(x_0)}{x_0} = ax_0^2 + (b + o(1))x_0^3 = \frac{f(x_1)}{x_1} = ax_1^2 + (b + o(1))x_1^3 = \delta. \quad (2.8)$$

Taking square root and expressing x_1 as an implicit function $-x_0(1 + o(1))$ of x_0 yields

$$x_1 = -x_0 + (c + o(1))x_0^2, \quad c = -\frac{b}{a}.$$

Writing the projective involution $\sigma_{Q,S} : \ell_\delta \rightarrow \ell_\delta$ fixing the origin and permuting the above intersection points as a fractional-linear transformation in the coordinate x , we get a transformation

$$x \mapsto -\frac{x}{1 + \nu(\delta)x}. \quad (2.9)$$

Substituting x_0 to (2.9) yields

$$-\frac{x_0}{1 + \nu(\delta)x_0} = -x_0 + (c + o(1))x_0^2;$$

$$(1 + \nu(\delta)x_0)(1 - (c + o(1))x_0) = 1, \quad x_0 = x_0(\delta) \rightarrow 0,$$

as $\delta \rightarrow 0$. Therefore, $\nu(\delta) = c + o(1) \rightarrow c$, and the one-parametric holomorphic family of transformation (2.9) extends holomorphically to $\delta = 0$ as the projective transformation $x \mapsto -\frac{x}{1+cx}$ (continuity and Erasing Singularity Theorem). The proposition is proved. \square

Claim 12. *The polar cubic S is σ_Q -invariant.*

Proof The projective involution $\sigma_{Q,S}$ from Proposition 2.15 fixes S and each line through Q . It preserves the collection of indeterminacy points of the integral R . Indeed, it fixes the indeterminacy point $(1, 1)$, since the line tangent to S at $(1, 1)$ passes through Q , and permutes the two other indeterminacy points $O = (0, 0)$ and ∞ , by construction. Therefore, it preserves the conic γ , which is the unique regular conic tangent to S at the three indeterminacy points. Indeed, if there were two such distinct conics, then their total intersection index at the three latter points would be no less than 6, – a contradiction to Bézout Theorem. Therefore, $\sigma_{Q,S}$ is the γ -angular symmetry, and hence, it coincides with σ_Q . This implies that $\sigma_Q(S) = S$. The claim is proved. \square

Claim 12 together with σ_Q -invariance of the zero locus γ of the function R yields $R \circ \sigma_Q = \pm R$. The restriction of the integral R to the line ℓ through Q tangent to the conic γ at the point $(1, 1)$ is holomorphic and nonconstant at $(1, 1)$: its numerator restricted to ℓ has order 6 zero at $(1, 1)$, and its denominator has order 4 zero there. The point $(1, 1)$ is fixed by σ_Q . Therefore, the above equality holds with sign “+” near the point $(1, 1)$, and hence, everywhere. Case iii) is treated. Proposition 2.14 is proved. \square

Recall that in our case of a multibilliard containing a conic with an exotic dual billiard structure, the involution associated to each vertex is a projective angular symmetry (Lemma 2.11). As it is shown below, this together with the next proposition implies Theorem 1.35.

Proposition 2.16 *Consider an exotic rationally integrable dual billiard on a conic γ . Let R be its canonical integral. Let $A \in \mathbb{CP}^2$, and let $\sigma_A : \mathbb{CP}^2 \rightarrow \mathbb{CP}^2$ be a projective angular symmetry centered at A that preserves the foliation $R = \text{const}$. Then σ_A is the γ -angular symmetry centered at A , and A is admissible: belongs to the list from Theorem 1.35.*

Proof Set $d = \deg R \in 2\mathbb{N}$. The (punctured) conic γ is the only conical leaf of multiplicity $\frac{d}{2}$ of the foliation $R = \text{const}$, see Lemma 2.8, Statement 3). Therefore, $\sigma_A(\gamma) = \gamma$. Hence, $A \notin \gamma$, since σ_A is a projective involution. Thus, σ_A is the γ -angular symmetry centered at A . It preserves the set of indeterminacy points of the integral R , whose number is either two, or three, since it preserves the foliation $R = \text{const}$. Hence, it preserves the union of lines tangent to γ at the indeterminacy points.

Consider first Case 2a), where there are 2 indeterminacy points: in the affine chart (z, w) these are the origin O and the infinity point B of the parabola γ . Let L_O, L_B denote the lines tangent to γ at them, and let Q be their intersection point. Let us show that $A = Q$: this is Case (i) from Theorem 1.35. The infinity line L_B is a leaf of the foliation $R = \text{const}$, while L_O isn't. Therefore, the lines L_B and L_O are σ_A -invariant. Suppose the contrary: $A \neq Q$. If $A \notin L_O \cup L_B$, then for every line $\ell \neq AQ$ the restriction $\sigma_A|_\ell$ fixes three distinct points: the point A and the intersections $\ell \cap L_O, \ell \cap L_B$. Hence, $\sigma_A|_\ell = \text{Id}$, – a contradiction. Thus, $A \in L_O \cup L_B$. Let us consider the case, when $A \in L_O$; the case, when $A \in L_B$ is treated analogously. Then the restriction $\sigma_A|_{L_O}$ fixes three distinct points Q, A, O ($A \neq O$, since $A \notin \gamma$), – a contradiction, as above. Thus, $A = Q$.

Case 2b). Then there are three indeterminacy points, and we can name them by X, Y, Z so that $R|_{YZ} \equiv \text{const} \neq \infty$, while $R|_{XY}, R|_{XZ} \equiv \infty$. In Subcase 2b1) $X = (1, 1)$, and Y, Z are the origin and the infinity point of the parabola γ . The involution σ_A should fix one of the indeterminacy points and permute two other ones: otherwise it would fix the three indeterminacy points lying on an invariant rational curve γ , and hence, $\sigma_A|_\gamma = \text{Id}$, – a contradiction. We claim that it fixes X and permutes Y and Z . Indeed, suppose the contrary: σ_A fixes, say, Y and permutes X and Z . Then $\sigma_A(XY) = YZ$ and $\sigma_A(XZ) = XZ$. On the other hand, σ_A should send level sets of the integral R to its level sets, since this is true for generic, irreducible level sets of degree $\deg R$, and remains valid after passing to limit. Thus, σ_A should preserve the infinity level set, since $\sigma_A(XZ) = XZ$. On the other hand, it should permute it with a finite level set containing the line YZ , since $\sigma_A(XY) = YZ$. The contradiction thus obtained proves that $\sigma_A(X) = X$ and $\sigma_A(Y) = Z$. This together with the fact that σ_A is a γ -angular symmetry implies that A is the intersection point of the line YZ with the tangent line to γ at X . Thus, the pair (A, σ_A) is the same, as in the Cases (ii) of Theorem 1.35. These cases are obtained one from the other by complex projective transformation, as in Theorem 1.18.

Case 2c1). (Case 2c2) is obtained from it by projective transformation.) The integral R has three indeterminacy points lying on the conic γ . Let us denote them by X, Y, Z . Then one of them, say, X , is fixed by the γ -angular symmetry σ_A , and the two other ones are permuted, as in the above discussion. This implies that A is the intersection point of the line tangent to γ at X and the line YZ . Thus, it is admissible in the sense of Theorem 1.35, case (iii).

In Case 2c2) all the admissible vertices are real, since so are the indeterminacy points. In Case 2c1) $X = (1, 1)$ is the unique real indeterminacy point; the other ones are $Y = (\varepsilon, \bar{\varepsilon})$ and $Z = (\bar{\varepsilon}, \varepsilon)$, where $\varepsilon = e^{\frac{2\pi i}{3}}$. The intersection of the line $\{w = 2z - 1\}$ tangent to γ at $(1, 1)$ and the line YZ is the admissible vertex $(0, -1)$. Each one of the complex lines

XZ , XY has non-real slope, and hence, X is its unique real point. Therefore, the other admissible vertex lying there is not real. Thus, in Case 2c1) the point $(0, -1)$ is the unique real admissible vertex.

Case 2d). The corresponding integral $R = R_d$ has three indeterminacy points: the origin O , the point $(1, 1)$ and the infinity point of the conic γ . The line $\{z = 1\}$ through the two latter indeterminacy points lies in a level curve of the integral R : namely, in its polar locus. On the other hand, R is non-constant on the lines $\{z = 0\}$ and $\{z = w\}$ passing through the origin and the other indeterminacy points. This implies that every projective transformation preserving the foliation $R = \text{const}$ should fix O . Let us show that it cannot be a γ -angular symmetry. Suppose the contrary: it is the γ -angular symmetry σ_A centered at a point A . Then σ_A has to fix O and to permute the two other indeterminacy points, as in Case 2b) discussed above. Thus, A is the intersection point of the line $\{z = 1\}$ through them and the Oz -axis (the line tangent to γ at O), i.e., $A = (1, 0)$. The involution σ_A fixes the line $\{z = 1\}$, which lies in the polar locus of the integral R . Hence, it preserves the whole polar locus, as in the above Case 2b). The polar locus consists of the line $\{z = 1\}$, the regular conic $\alpha := \{w = -8z^2\}$ and an irreducible rational cubic, see [30, proposition 7.15]. Hence, σ_A fixes the conic α . Thus, it permutes its infinite point (coinciding with that of γ) and its other, finite intersection point $(1, -8)$ with the line $\{z = 1\}$. On the other hand, it should send the infinite point to the point $(1, 1) \in \gamma \cap \{z = 1\}$, since σ_A is the γ -angular symmetry. The contradiction thus obtained proves that if a multibilliard contains a conic with exotic dual billiard structure of type 2d), then it contains no vertices. The proof of Theorem 1.35 is complete. \square

Proof of Proposition 1.36. Complex projective equivalence of billiards of type (ii) is obvious. Let us prove the analogous second statement of Proposition 1.36 on billiards of type (iii). The dual billiard structure on γ of type 2c1) admits the order 3 symmetry $(z, w) \mapsto (\varepsilon z, \bar{\varepsilon} w)$ cyclically permuting the indeterminacy points of the integral. Therefore, it also permutes cyclically admissible vertices and hence, acts transitively on them and on their unordered pairs. The same statement holds for type 2c2), since the dual billiards 2c1) and 2c2) are complex-projectively isomorphic. This implies the second statement of Proposition 1.36. In the case of type 2c2) the indeterminacy points are real, and hence, so are the admissible vertices, and the order 3 symmetry is a real projective transformation. This together with the above discussion implies the third statement of Proposition 1.36. \square

2.6 Real admissible vertices (lines) of (dual) pencils of conics. Proof of Propositions 1.28 and 1.45

Proof of Proposition 1.28. The ambient projective plane $\mathbb{C}\mathbb{P}^2$ is the projectivization of a three-dimensional complex vector space \mathbb{C}^3 . The complex conjugation involution acting on \mathbb{C}^3 induces its action on $\mathbb{C}\mathbb{P}^2$, which will be also called conjugation. It sends projective lines to projective lines and preserves the complexification of every real pencil of conics. An admissible vertex is uniquely determined by its involution. Thus, if the latter is real, then so is the former and so is the corresponding fixed point line (conic). Conversely, if both the

vertex and the fixed point line (conic) are real, then the involution is real. Let us show, case by case, that if the involution is projective, then reality of the vertex automatically implies reality of the fixed point line (and hence, of the involution). Simultaneously we describe those vertices that are always real.

Case a): pencil of real conics through four distinct (may be complex) points A, B, C, D . The conjugation permutes the points A, B, C, D . Therefore, it permutes vertices M_1, M_2 and M_3 . Hence, at least one of them is fixed (say, M_1), or equivalently, real. The line through the other points M_2, M_3 should be fixed, and thus, real, since the union $\{M_2, M_3\}$ is invariant. Finally, the involution σ_{M_1} is real.

Let now the point K_{AB} be real. Then the ambient line AB is invariant under the conjugation, since the collection of complex lines through pairs of permuted base points of the pencil is invariant and the line AB is uniquely determined by K_{AB} . Indeed, otherwise K_{AB} would be an intersection point of the line AB with a line $EF \neq AB$ through some distinct base points E and F . Hence, it would be either some of base points of the pencil, or some of M_j 's, which is clearly impossible. Therefore, AB is a real line, and the set $\{A, B\}$ is conjugation invariant. Hence, so is $\{C, D\}$, and the fixed point line CD of the involution $\sigma_{K_{AB}}$ is real. Thus, $\sigma_{K_{AB}}$ is also real.

The case, when C, D are real and A, B aren't is possible. In this case A and B are permuted by the conjugation. Hence, the points M_2 and M_3 are also permuted, and thus, they are not real. Similarly, K_{BC} and K_{AC} are permuted, K_{BD} and K_{AD} are permuted, and hence, they are not real.

Case b): real pencil of conics through 3 points A, B, C tangent at the point C to the same line L . See Fig. 4. The point C and the line L should be obviously fixed by conjugation, and hence, real. Therefore, the points A, B are either both fixed, or permuted. Hence, the line AB is real, and so is $M = AB \cap L$. The point $K_{AB} \in AB$ is defined by the condition that the quadruple of points $M, K_{AB}, A, B \in AB$ is harmonic. It is real, since complex conjugation acting on the complex line AB preserves harmonicity and so does the permutation of the points A and B . Therefore, the line CK_{AB} is real, and so is σ_M . The global projective involutions σ_C and $\sigma_{K_{AB}}$ are both real, since so are the lines AB and L .

Case c): real pencil of conics through two distinct points A, C tangent at them to two given lines L_A and L_C . See Fig. 5. A priori, the points A and C need not be real. For example, a pencil of concentric circles satisfies the above statements with $A = [1 : i : 0]$, $C = [1 : -i : 0]$: the so-called isotropic points at infinity. The line AC is real, and so is $M = L_A \cap L_C$, since the complex conjugation either permutes A and C (and hence, the lines L_A and L_C), or fixes them. Therefore, the involution σ_M is real. The point M' , which is an arbitrary point of the complex line AC , needs not be real. But if it is real, then so is the involution $\sigma_{M'}$. Indeed, $\sigma_{M'}$ can be equivalently defined to fix M' and the line through M and the point $K \in AC$ for which the quadruple M', K, A, C is harmonic. If M' is real, then so is K , as in the above case. Hence, the line MK is real and so is $\sigma_{M'}$.

Cases d) and e). Reality of the vertex A is obvious. Let now $C \in L \setminus \{A\}$ be a vertex from d2) or e2). Clearly σ_C can be real only if C is. Let C be real. In Case d2) the point B is fixed, being the unique transversal intersection point of the conics of the pencil. Hence,

the fixed point line AB of the involution σ_C is real. Thus, σ_C is real. In Case e2) take a real conic α of the pencil. There exists a unique real tangent line to α through C different from L . Let E denote their tangency point. Then AE is the fixed point line of the involution σ_C , by definition, and it is real. Hence, σ_C is real. Proposition 1.28 is proved. \square

Proof of Proposition 1.45. It suffices to prove its dual version: a real pencil of conics through four distinct complex base points A, B, C, D has two *real* neighbor skew vertices K_{EF}, K_{FS} , if and only if all the base points are real. See Remark 1.41. If the base points are real, then clearly so are all the skew vertices. Let us now suppose that two neighbor vertices, say, K_{AB} and K_{BC} are real, and prove that all the base points are real. Indeed, then the corresponding lines AB and BC are real, see the above proof of Proposition 1.28. Thus, their intersection point B is real. Hence, the other base points $A \in AB$ and $C \in BC$ are real. Hence, the remaining base point D is real, since the complex conjugation cannot permute it with another base point. Thus, each base point is real. Proposition 1.45 is proved. \square

3 Rationally 0-homogeneously integrable piecewise smooth projective billiards. Proof of Theorems 1.42, 1.43, 1.50

The first step of their classification is the following lemma.

Lemma 3.1 *Let a planar projective billiard with piecewise C^4 -smooth boundary containing a nonlinear arc be rationally 0-homogeneously integrable. Then the boundary consists of conical arcs and straightline segments. The projective billiard structure of each conical arc is either of dual pencil type, or an exotic one from Statement 2) of Theorem 1.20.*

Proof A rational 0-homogeneous integral of the billiard is automatically such an integral for the projective billiard on each nonlinear arc. Hence, by Theorem 1.20, the nonlinear arcs are conics, and each of them is equipped with a projective billiard structure either of dual pencil type, or exotic. \square

Below we describe the possible combinations of conical arcs and straightline segments equipped with projective billiard structures that yield altogether a rationally integrable projective billiard. We reduce this description to the classification of rationally integrable dual multibilliards. To do this, we use the projective duality given by orthogonal polarity, see Subsection 1.1, which transforms a projective billiard to a dual multibilliard. We show that the former is rationally 0-homogeneously integrable, if and only if the latter is rationally integrable. We present a one-to-one correspondence between integrals of the former and of the latter. Afterwards the main results on classification of rationally 0-homogeneously integrable projective billiards follow immediately by duality from those on dual multibilliards.

3.1 Duality and correspondence between integrals

Consider a projective billiard in \mathbb{R}_{x_1, x_2}^2 with piecewise C^4 -smooth boundary where each C^4 -smooth arc is either strictly convex, or a straightline segment. This holds automatically, if all the nonlinear boundary arcs are conical, as in Lemma 3.1. Consider the ambient plane \mathbb{R}_{x_1, x_2}^2 as the horizontal plane $\{x_3 = 1\} \subset \mathbb{R}_{x_1, x_2, x_3}^3$. We identify it with the standard affine chart $\{x_3 = 1\} \in \mathbb{RP}_{[x_1: x_2: x_3]}^2$ by tautological projection. Consider the projective duality given by the orthogonal polarity, see Subsection 1.1. Recall that it sends each line $L \subset \mathbb{R}^2 \subset \mathbb{RP}^2$ to a point in \mathbb{RP}^2 . In more detail, for every $r = (x_1, x_2, 1) \in \mathbb{R}^2$ and $v = (v_1, v_2, 0) \in T_r \mathbb{R}^2$ the line through r tangent to v is sent to the point $[\mathcal{M}_1 : \mathcal{M}_2 : \mathcal{M}_3]$, $\mathcal{M} = [r, v]$, see Remark 1.12. The duality transforms a piecewise smooth projective billiard to a dual multibilliard, as explained in Subsection 1.1 and formalized by the following definition.

Definition 3.2 Consider a projective billiard as above. Its *dual multibilliard* is the collection of curves α^* in \mathbb{RP}^2 dual⁶ to its C^4 -smooth nonlinear boundary arcs α , and the points A (called *vertices*) dual to the ambient lines of the straightline intervals contained in its boundary. Each curve α^* and each point A are equipped with the dual billiard structures dual to the projective billiard structures on the corresponding boundary arcs. See Definitions 1.9, 1.14 and the discussions just before them. (Note that a priori a vertex in a multibilliard may appear several times, with different dual billiard structures. They correspond to projective billiard structures on different boundary intervals lying in one and the same line.)

We can and will consider that the dual multibilliard lies in the projective plane equipped with homogeneous coordinates $[\mathcal{M}_1 : \mathcal{M}_2 : \mathcal{M}_3]$, see the above discussion.

Proposition 3.3 1) *A projective billiard is rationally 0-homogeneously integrable, if and only if its dual multibilliard is rationally integrable.*

2) *Each rational 0-homogeneous integral of degree n (if any) of the projective billiard is a rational 0-homogeneous function of the moment vector $\mathcal{M} = (\mathcal{M}_1, \mathcal{M}_2, \mathcal{M}_3)$, $\mathcal{M} = [r, v]$, of the same degree n . As a function of \mathcal{M} , it is an integral of the dual multibilliard.*

3) *Conversely, let R be a rational integral of the dual multibilliard written as a ratio of two homogeneous polynomials of degree n in $(\mathcal{M}_1, \mathcal{M}_2, \mathcal{M}_3)$. Then $R([r, v])$ is a rational 0-homogeneous integral of the projective billiard of the same degree n .*

Proof The statements of the proposition extend [30, propositions 1.23, 1.24] (formulated for a projective billiard on a connected curve) to projective billiards with piecewise C^4 -smooth boundary. The proofs given in [30, subsections 9.1, 9.2] remain valid in this more

⁶The curves α^* are C^4 -smoothly immersed, as are the curves α . In general, for every $m \geq 2$ the dual to a C^m -smoothly immersed curve α is a C^m -smoothly immersed curve α^* . Note that in general, the straightforward parametrization of the dual curve α^* induced by a C^m -smooth parametrization of the curve α is not C^m -smooth. But one can choose the parameter of the dual curve to make its parametrization C^m -smooth.

general case. The second part of Statement 2) states that a function of $\mathcal{M} = [r, v]$ that is an integral of the projective billiard flow is an integral of the dual billiard (considered as a function of \mathcal{M}). It follows immediately from the fact that each integral of the projective billiard flow is reflection invariant, and for a function of \mathcal{M} reflection invariance in the projective billiard is equivalent to being an integral of the multibilliard. See [30, the end of subsection 9.2]. \square

Corollary 3.4 *The minimal degree of rational 0-homogeneous integral of a projective billiard is equal to the minimal degree of rational integral of its dual multibilliard.*

3.2 Rationally 0-homogeneously integrable billiards on surfaces of constant curvature. Proof of Proposition 1.8

Polynomial integrability implies rational 0-homogeneous integrability with rational integral of degree 2 or 4 (the minimal degree of a nonlinear polynomial integral). Indeed, in this case there always exists a nontrivial polynomial homogeneous in v first integral $I(x, v)$ of degree $n \in \{2, 4\}$, see [28, theorem 1.21 and proposition 1.19]. Then the ratio $\frac{I(x, v)}{\|v\|^n}$ is a nonconstant rational 0-homogeneous integral of the billiard flow. Let us prove the converse: rational 0-homogeneous integrability implies polynomial integrability.

Let Σ be a surface of constant curvature realized as a surface in the space \mathbb{R}^3 equipped with appropriate quadratic form $\langle \mathcal{A}x, x \rangle$, $x = (x_1, x_2, x_3)$, \langle, \rangle is the Euclidean scalar product, \mathcal{A} is a real symmetric matrix:

Case, when $\Sigma = \mathbb{R}^2$: $\mathcal{A} = \text{diag}(1, 1, 0)$, $\Sigma = \{x_3 = 1\}$.

Case, when $\Sigma = S^2$: $\mathcal{A} = Id$, $\Sigma = \{x_1^2 + x_2^2 + x_3^2 = 1\}$.

Case of $\Sigma = \mathbb{H}^2$: $\mathcal{A} = \text{diag}(1, 1, -1)$, $\Sigma = \{\langle \mathcal{A}x, x \rangle = -1\} \cap \{x_3 > 0\}$.

Consider an arbitrary rationally 0-homogeneously integrable billiard with piecewise C^2 -smooth boundary on Σ . We show that it admits a special rational 0-homogeneous integral, whose denominator is a power of $\langle \mathcal{A}v, v \rangle$. Then we deduce that its numerator is a non-trivial polynomial integral.

For every $r = (r_1, r_2, r_3) \in \Sigma$ and $v \in T_r\Sigma$ (treated as a vector in \mathbb{R}^3) set

$$\mathcal{M} = (\mathcal{M}_1, \mathcal{M}_2, \mathcal{M}_3) = \mathcal{M}(r, v) = [r, v]. \quad (3.1)$$

Let Ψ be a nonconstant rational 0-homogeneous integral. Then it is a rational 0-homogeneous function of \mathcal{M} with constant coefficients. Indeed, consider the tautological projection $\pi : \Sigma \rightarrow \mathbb{RP}^2$. For simplicity we consider that the billiard is projected to the affine chart $\mathbb{R}^2 = \{x_3 = 1\} \subset \mathbb{RP}^2$, which will be identified with the plane $\{x_3 = 1\} \subset \mathbb{R}_{x_1, x_2, x_3}^3$ (the opposite case is treated analogously). In the latter affine chart the projection is given by the formula $\pi(r) = r' := \frac{r}{r_3} = (x_1, x_2, 1)$. The image of the given billiard is a projective billiard, see Example 1.2. For every $r \in \Sigma$ and $v \in T_r\Sigma$ set

$$v' := d\pi(r)(v) \in T_{r'}\mathbb{R}^2, \quad \mathcal{M}' := [r', v'].$$

The function $\tilde{\Psi}(r', v') := \Psi(r, v)$ is a rational 0-homogeneous integral of the projective billiard, which follows by construction and 0-homogeneity. It is a rational 0-homogeneous function of \mathcal{M}' , by Proposition 3.3. Therefore, Ψ is a rational 0-homogeneous function of $\mathcal{M} = [r, v]$, by 0-homogeneity and since the vectors \mathcal{M}' , \mathcal{M} are proportional for every $r \in \Sigma$ and $v \in T_r \Sigma$. Let us write $\Psi = \Psi(\mathcal{M}) = \frac{F(\mathcal{M})}{G(\mathcal{M})}$ as an irreducible fraction. Then the complex zero divisors of the polynomials F and G are essentially distinct in the sense that their intersection has complex codimension at least two in $\mathbb{C}\mathbb{P}^2$. The divisor of one of them, say F , is not a multiple of the light conic divisor

$$\mathbb{I} := \{ \langle \mathcal{A}\mathcal{M}, \mathcal{M} \rangle = 0 \} \subset \mathbb{C}\mathbb{P}^2_{[\mathcal{M}_1 : \mathcal{M}_2 : \mathcal{M}_3]}.$$

Consider the rational 0-homogeneous function

$$R(\mathcal{M}) := \frac{F^2(\mathcal{M})}{\langle \mathcal{A}\mathcal{M}, \mathcal{M} \rangle^{2n}}, \quad n := \deg F. \quad (3.2)$$

We claim that R^2 is an integral of the projective billiard. Or equivalently, the same function considered as a function of $[\mathcal{M}_1 : \mathcal{M}_2 : \mathcal{M}_3] \in \mathbb{C}\mathbb{P}^2$ is an integral of the multibilliard dual to the projective billiard. Indeed, let us show that for every (complex) line L tangent to a (complexified) curve of the multibilliard (or a line through its vertex) the corresponding involution leaves invariant the restriction $R^2|_L$. Indeed, it leaves invariant the intersection of the line L with the zero divisor of the polynomial F by invariance of the restriction $\Psi|_L$ (since Ψ is an integral of the multibilliard). It also leaves invariant the intersection $L \cap \mathbb{I}$, since the involution in question is a \mathbb{I} -angular symmetry restricted to L , being dual to reflection in a billiard on constant curvature surface, see [28, subsection 2.1, corollary 2.3 and proposition 2.5]. Therefore, the restriction $R|_L$ and its image under the involution have the same divisors, and hence, are proportional. The proportionality coefficient is equal to ± 1 , since the transformation in question is an involution acting linearly on the space of rational functions on L . Hence, $R^2|_L$ is invariant under the involution. Thus, R^2 is a nonconstant integral of the multibilliard. Therefore, the function $R^2(\mathcal{M})$, $\mathcal{M} = [r, v]$, is a nonconstant rational 0-homogeneous integral of the flow of the projective billiard, and hence, of the flow of the initial billiard on Σ . Its denominator $\langle \mathcal{A}\mathcal{M}, \mathcal{M} \rangle^{2n}$ is equal to $\langle \mathcal{A}v, v \rangle^{2n}$, by Bolotin's result stating that for every fixed $r \in \Sigma$ the restricted moment map $v \mapsto [r, v]$ is an isometry of two-dimensional spaces $T_r \Sigma$ and r^\perp equipped with the quadratic form $\langle \mathcal{A}x, x \rangle$, see [16, formula (15), p. 23], [34, formula (3.12), p. 140]. Therefore, the integral $R^2(\mathcal{M})$ of the billiard flow is a ratio of a homogeneous polynomial in v and a trivial polynomial integral $\langle \mathcal{A}v, v \rangle^{2n}$. Hence, its numerator is a polynomial integral. It is non-constant along the unit velocity hypersurface $\{ \langle \mathcal{A}v, v \rangle = 1 \}$, since R^2 is 0-homogeneous and nonconstant. Therefore, the billiard in question is polynomially integrable.

Now for the proof of Proposition 1.8 it remains to show that if a billiard on a constant curvature surface is polynomially integrable, then the minimal degree of rational integral is equal to the minimal degree d of a nonlinear non-trivial polynomial integral $F(\mathcal{M})$:

$d \in \{2, 4\}$. Indeed, the ratio

$$\Phi(\mathcal{M}) := \frac{F(\mathcal{M})}{\langle \mathcal{A}v, v \rangle^{\frac{d}{2}}} = \frac{F(\mathcal{M})}{\langle \mathcal{A}\mathcal{M}, \mathcal{M} \rangle^{\frac{d}{2}}}$$

is a rational 0-homogeneous integral of degree d . Suppose the contrary to the above minimal degree equality. Then the minimal degree of a rational integral is less than d . Therefore, $d = 4$ and the minimal degree of a rational integral is equal to 2, since it is known to be an even number (for the projective billiard, and hence, for the initial billiard). Let R be a quadratic integral written as a function $R(\mathcal{M}) = R(\mathcal{M}')$. Its restriction to a curve dual to a nonlinear arc of the boundary of the projective billiard is constant, see [30, proposition 3.5] (see also Proposition 2.7). Hence, the foliation $R = \text{const}$ is a pencil \mathcal{P} of conics whose generic conic is nonlinear. Therefore the dual multibilliard to the projective billiard is of pencil type with respect to the same pencil \mathcal{P} . Let us show that the light conic \mathbb{I} lies in \mathcal{P} . The foliations $\Phi = \text{const}$ and $R = \text{const}$ coincide, by Proposition 2.7. Hence, each level curve of the function Φ , which has degree 4, is a union of at most two conics of the pencil \mathcal{P} . Its polar locus is the light conic \mathbb{I} taken twice. Hence, the conic \mathbb{I} taken twice is a union of at most two conics of the pencil \mathcal{P} . If $\Sigma \neq \mathbb{R}^2$, then the conic \mathbb{I} is irreducible, and hence, is a conic of the pencil \mathcal{P} . If $\Sigma = \mathbb{R}^2$, then \mathbb{I} is the union of two lines $L_{\pm} = \{\mathcal{M}_1 = \pm i\mathcal{M}_2\}$, and either $\mathbb{I} \in \mathcal{P}$, or each double line L_{\pm} is a conic from \mathcal{P} . The latter case is impossible, since then the whole pencil \mathcal{P} would entirely consist of double lines and would contain no regular conic, – a contradiction. Finally, $\mathbb{I} \in \mathcal{P}$. Then one can write $R = \frac{Q(\mathcal{M})}{\langle \mathcal{A}\mathcal{M}, \mathcal{M} \rangle}$, replacing R by its postcomposition with a Möbius transformation. Then the polynomial $Q(\mathcal{M})$ is a non-trivial quadratic integral of the billiard on Σ . This contradicts our assumption that the minimal degree of polynomial integral is equal to 4. Proposition 1.8 is proved.

3.3 Case of dual pencil. Proof of Theorems 1.42, 1.43, 1.44

We use the following proposition.

Proposition 3.5 *Let \mathcal{P} be a pencil of conics, \mathcal{P}^* be its dual pencil.*

1) *Let $\alpha \subset \mathbb{R}^2 \subset \mathbb{R}\mathbb{P}^2$ be a conical arc whose ambient conic lies in \mathcal{P}^* , equipped with the projective billiard structure defined by \mathcal{P}^* . Then its dual is the dual conical arc α^* equipped with the dual billiard structure of pencil type, defined by the pencil \mathcal{P} . The converse statement also holds.*

2) *A planar projective billiard is of dual pencil type, defined by the dual pencil \mathcal{P}^* , if and only if its dual multibilliard is of pencil type, defined by \mathcal{P} .*

Proof Statement 1) of the proposition follows from definition. The definitions of dual multibilliard of pencil type and projective billiard of dual pencil type are dual to each other: the standard (skew) admissible lines for the dual pencil \mathcal{P}^* are dual to the standard (skew) admissible vertices for the pencil \mathcal{P} . See Remark 1.41. This implies Statement 2). \square

Proof of Theorem 1.42. Let a projective billiard with piecewise C^4 -smooth boundary containing a nonlinear arc be rationally 0-homogeneously integrable. Then its dual multibilliard is rationally integrable (Proposition 3.3). Hence, each its curve is a conic equipped with either pencil type, or exotic dual billiard structure (Theorem 1.29). Thus, the nonlinear arcs of projective billiard boundary are conical, and each of them is equipped with either a dual pencil type, or exotic projective billiard structure. Let the projective billiard contain at least two arcs of two distinct conics. Then the multibilliard contains their dual conics, which are also distinct. Hence, they are equipped with the dual billiard structure defined by the pencil \mathcal{P} containing them, each conic of the multibilliard lies in the same pencil \mathcal{P} and is equipped with the dual billiard structure defined by \mathcal{P} (Theorem 1.29). Thus, all the conical arcs of the projective billiard boundary lie in the dual pencil \mathcal{P}^* and are equipped with the projective billiard structures defined by \mathcal{P}^* , by Proposition 3.5, Statement 1). Theorem 1.42 is proved. \square

Proof of Theorem 1.43. Let in a projective billiard all the nonlinear boundary arcs be conics lying in a dual pencil \mathcal{P}^* , with the projective billiard structures defined by \mathcal{P}^* . Then the curves of the dual multibilliard are conics lying in the pencil \mathcal{P} , equipped with the dual billiard structure defined by \mathcal{P} . The projective billiard is rationally 0-homogeneously integrable, if and only if the dual multibilliard is rationally integrable, by Proposition 3.3, Statement 1). The latter holds, if and only if the multibilliard is of pencil type (Theorem 1.30); or equivalently, the projective billiard is of dual pencil type (Proposition 3.5, Statement 2)). Theorem 1.43 is proved. \square

Theorem 1.44 follows immediately from Theorem 1.31 and Corollary 3.4 by duality, since (neighbor) skew admissible lines for a dual pencil \mathcal{P}^* are dual to (neighbor) skew admissible vertices for the pencil \mathcal{P} and vice versa.

3.4 Exotic projective billiards. Proof of Theorem 1.50

Let a projective billiard have boundary that consists of conical arcs of one and the same conic equipped with an exotic dual billiard structure from Theorem 1.20, Case 2), and maybe some straightline segments. It is rationally 0-homogeneously integrable, if and only if the corresponding dual multibilliard is rationally integrable, by Proposition 3.3, Statement 1). In appropriate coordinates the dual multibilliard consists of one conic $\gamma = \{w = z^2\} \subset \mathbb{R}_{z,w}^2 = \{t = 1\} \subset \mathbb{RP}_{[z:w:t]}^2$ equipped with the corresponding exotic dual billiard structure from Theorem 1.17 and maybe some vertices. It is rationally integrable, if and only if either it has no vertices, or each its vertex is admissible in the sense of Theorem 1.35. This holds if and only if the ambient lines of the projective billiard boundary segments are dual to the admissible vertices, and their corresponding projective billiard structures are dual to the dual billiard structures at the vertices. Let us show, case by case, that the lines dual to the admissible vertices are the admissible lines from Theorem 1.50. To do this, we use the following proposition.

Proposition 3.6 *Consider the above parabola γ equipped with an exotic dual billiard structure from Theorem 1.17, Case 2). Let $C \subset \mathbb{RP}_{[z:w:t]}^2$ denote the conic orthogonal-polar-dual to γ .*

1) *The projectivization $[F] : \mathbb{RP}_{[z:w:t]}^2 \rightarrow \mathbb{RP}_{[x_1:x_2:x_3]}^2$ of the linear map*

$$F : (z, w, t) \mapsto (x_1, x_2, x_3) := \left(\frac{z}{2}, t, w\right) \quad (3.3)$$

sends C to the parabola $\{x_2x_3 = x_1^2\}$, which will be now referred to, as C ,

$$C \cap \{x_3 = 1\} = \{x_2 = x_1^2\},$$

equipped with the corresponding projective billiard structure from Theorem 1.20, Case 2).

2) *For every point $(z_0, z_0^2) \in \gamma$ the corresponding point of the dual curve C has $[x_1 : x_2 : x_3]$ -coordinates $[-z_0 : z_0^2 : 1]$.*

3) *The points in C corresponding to $O = (0, 0), (1, 1), \infty \in \gamma$ are respectively $[0 : 0 : 1] = (0, 0), [-1 : 1 : 1] = (-1, 1), [0 : 1 : 0] = \infty$ in the coordinates $[x_1 : x_2 : x_3]$ and in the coordinates (x_1, x_2) in the affine chart $\mathbb{R}_{x_1, x_2}^2 = \{x_3 = 1\}$.*

Proof Statements 1) and 2) follow from [30, claim 14, subsection 9.4] and the discussion after it. Statement 3) follows from Statement 2). \square

Each admissible vertex Q for an exotic dual billiard structure on γ does not lie on γ , and the corresponding involution σ_Q is the γ -angular symmetry centered at Q . The set of its fixed points distinct from Q is the line L through the tangency points of the curve γ with two lines through Q . The dual object to the pair (Q, σ_Q) is the dual line Q^* equipped with the projective billiard structure given by the transversal line field through the point L^* dual to L . Below we find Q^* and L^* case by case and check that the line Q^* is admissible.

Case 2a). The only admissible vertex of the dual billiard on γ is the intersection point $Q = [1 : 0 : 0]$ of the tangent lines to γ at the origin and the infinity. It is equipped with the projective involution $[z : w : t] \mapsto [-z : w : t]$ fixing the points of the line $L = Ow$ through the origin and the infinity. The duality sends the above tangent lines to the origin and to the infinity respectively in the coordinates (x_1, x_2) . Thus, the dual line Q^* is the line L through the origin and the infinity, equipped with the field of lines through the point $L^* = Q = [1 : 0 : 0]$: the horizontal line field orthogonal to it. Hence, it is admissible.

Case 2b1) (Case 2b2) is treated analogously). The only admissible vertex $Q = (0, -1)$ is the intersection point of the tangent lines to γ at the points $(\pm 1, 1)$. Hence, the dual line Q^* is the line $\{x_2 = 1\}$ through the dual points $(\mp 1, 1)$ to the latter tangent lines, see Proposition 3.6, Statements 2), 3). The fixed point line of the involution σ_Q is the line $L = Q^* = \{x_2 = 1\}$ through the same two points. Hence, $L^* = Q = (0, -1)$. Thus, the line $Q^* = \{x_2 = 1\}$ is equipped with the field of lines through $(0, -1)$ and hence, is admissible.

Case 2c2). The dual billiard structure on the conic γ has three base (indeterminacy) points: $(0, 0), (1, 1), \infty$. Each admissible vertex is the intersection point of a line tangent to γ at one of them and the line through two other ones. The admissible vertices are $(1, 0), (0, -1)$ and $[1 : 1 : 0]$. The point $Q = (1, 0)$ is the intersection point of the Oz -axis (which is

tangent to γ at $(0, 0)$) and the line tangent to γ at the point $(2, 4)$. The fixed point line of the involution σ_Q is the line $L = \{x_2 = 2x_1\}$ through the above tangency points $(0, 0)$ and $(2, 4)$. Therefore, the dual line Q^* is the line $\{x_2 = -2x_1\}$ through the dual points $(0, 0)$, $(-2, 4)$ to the latter tangent lines, by Proposition 3.6, Statement 2). The dual point L^* is the intersection point $(-1, 0)$ of the lines dual to $(0, 0)$, $(2, 4)$, which are tangent to γ at the points $(0, 0)$, $(-2, 4)$. Finally, the line $Q^* = \{x_2 = -2x_1\}$ is equipped with the field of lines through the point $L^* = (-1, 0)$. Hence, it is admissible.

The line dual to the admissible vertex $(0, -1)$ is the line $\{x_2 = 1\}$ equipped with the field of lines through the point $(0, -1)$, as in Case 2b1). Hence, it is admissible.

The admissible vertex $Q = [1 : 1 : 0]$ is the intersection point of the lines tangent to γ at its infinite point $[0 : 1 : 0]$ and at the point $(\frac{1}{2}, \frac{1}{4})$. Thus, its dual line Q^* is the line $\{x_1 = -\frac{1}{2}\}$ through the points $[0 : 1 : 0]$ and $(-\frac{1}{2}, \frac{1}{4})$ dual to the above tangent lines, see Proposition 3.6, Statement 2). The fixed point line of the involution σ_Q is the line $\{x_1 = \frac{1}{2}\}$ through the above tangency points $[0 : 1 : 0]$ and $(\frac{1}{2}, \frac{1}{4})$. Therefore, its dual point L^* is the intersection point of the tangent lines to γ at the points $[0 : 1 : 0]$ and $(-\frac{1}{2}, \frac{1}{4})$. This is the point $[-1 : 1 : 0]$ of the infinity line. Finally, the line $Q^* = \{x_1 = -\frac{1}{2}\}$ is equipped with the field of lines parallel to the vector $(-1, 1)$. Hence, it is admissible.

Case 2c1). Then $(0, -1)$ is the unique real admissible vertex for the dual billiard. The only admissible line is its dual line $\{x_2 = 1\}$ equipped with the field of lines through the point $(0, -1)$, as in Cases 2c2) and 2b1).

Case 2d). There are no admissible lines, since the dual billiard has no admissible vertices (Theorem 1.35). Theorem 1.50 is proved.

4 Integrals of dual pencil type billiards: examples of degrees 4 and 12. Proof of Theorems 1.32, 1.46 and Lemma 1.47

First we prove Theorems 1.32, 1.46 and Lemma 1.47. Then we provide examples of dual pencil type projective billiards with integrals of degrees 4 and 12. Afterwards we discuss their realization by the so-called semi-(pseudo-) Euclidean billiards, with nonlinear part of boundary being equipped with normal line field for the standard (pseudo-) Euclidean form.

4.1 Multibilliards of pencil type. Proof of Theorem 1.32

We deal with multibilliards in $\mathbb{K}\mathbb{P}^2$, $\mathbb{K} = \mathbb{R}, \mathbb{C}$. For every admissible vertex V from Definition 1.25, Case a) (M_j or K_{EL}) equipped with the corresponding projective involution σ_V , let $\widehat{V} : \mathbb{K}^3 \rightarrow \mathbb{K}^3$ denote the linear involution whose projectivization is σ_V . We normalize it to fix the points of the two-dimensional subspace projected to the fixed point line of σ_V and to act as the central symmetry $\alpha \mapsto -\alpha$ on the one-dimensional subspace projected to V . Let \widehat{V}^* denote its conjugate, acting on the space \mathbb{K}^{3*} of linear functionals on \mathbb{K}^3 . The symmetric square $\text{Sym}^2(\mathbb{K}^{3*})$ is identified with the space of homogeneous quadratic polynomials on \mathbb{K}^3 . The operators \widehat{V}^* lifted to $\text{Sym}^2(\mathbb{K}^{3*})$ will be also denoted by \widehat{V}^* . In the proof of Theorem 1.32 we use the two following propositions.

Proposition 4.1 *Let a pencil have type a): conics through four different points A, B, C, D . One has*

$$(\widehat{K}_{EL}\widehat{K}_{LF})^3 = Id \quad \text{for every three distinct } E, L, F \in \{A, B, C, D\}. \quad (4.1)$$

Proof Let $N \in \{A, B, C, D\}$ be the point distinct from E, L, F . The involutions $\sigma_{K_{EL}}, \sigma_{K_{LF}}$ fix N ; $\sigma_{K_{EL}}$ fixes F and permutes E, L ; $\sigma_{K_{LF}}$ fixes E and permutes L, F . Hence, their product fixes N and makes an order three cyclic permutation of the points E, L, F . Thus, $\Pi := (\sigma_{K_{EL}} \circ \sigma_{K_{LF}})^3$ fixes all the four points $A, B, C, D \in \mathbb{K}\mathbb{P}^2$, hence $\Pi = Id$. Thus, $(\widehat{K}_{EL}\widehat{K}_{LF})^3 = Id$ up to constant factor. The latter constant factor should be equal to one, since the operator in question acts trivially on the one-dimensional subspace projected to N : this is true for both $\widehat{K}_{EL}, \widehat{K}_{LF}$, by definition, since N is the intersection point of the fixed point lines of the involutions $\sigma_{K_{EL}}, \sigma_{K_{LF}}$. This proves (4.1). \square

Recall that for every line $X \subset \mathbb{K}\mathbb{P}^2$ by $\xi_X \in \mathbb{K}^{3*}$ we denote a linear functional vanishing on the two-dimensional subspace $\pi^{-1}(X) \subset \mathbb{K}^3$ projected to X .

Proposition 4.2 1) *The subspace $W \subset \text{Sym}^2(\mathbb{K}^{3*})$ generated by the products $\xi_{EL}(Y)\xi_{(EL)'}(Y)$ with $(EL)'$ being the line through the pair of points $\{E', L'\} := \{A, B, C, D\} \setminus \{E, L\}$, is two-dimensional and \widehat{V}^* -invariant for every admissible vertex V . Each operator \widehat{V}^* corresponding to a standard admissible vertex acts on W as the identity up to constant factor.*

2) *The above functionals ξ_{EL} can be normalized so that*

$$\widehat{K}_{AB}^*(\xi_{AB}\xi_{CD}) = -\xi_{AB}\xi_{CD}, \quad \widehat{K}_{AB}^*(\xi_{BC}\xi_{AD}) = -\xi_{AC}\xi_{BD}, \quad (4.2)$$

and so that analogous formulas hold for the other operators \widehat{K}_{EL}^* .

Proof The zero conics of the polynomials $\xi_{EL}(Y)\xi_{(EL)'}(Y)$ are the singular conics $AB \cup CD, BC \cup AD, AC \cup BD$ of the pencil of conics through A, B, C, D . Hence, the zero locus of every their linear combination is a conic of the pencil, and hence, the space W spanned by them is two-dimensional. Its \widehat{V}^* -invariance follows from σ_V -invariance of the pencil. For every $V \in \{M_1, M_2, M_3\}$ the involution σ_V fixes the three above conics, and hence, each conic of the pencil. Thus $\widehat{V}^*|_W = Id$ up to constant factor.

Let us prove the first formula in (4.2) for arbitrary normalization of the functionals ξ_{AB} and ξ_{CD} . The operator \widehat{K}_{AB} fixes the points of the hyperplane $\pi^{-1}(CD)$ and acts as central symmetry on the complementary invariant subspace $\pi^{-1}(K_{AB})$. The latter subspace lies in the other invariant hyperplane $\pi^{-1}(AB)$. This implies that \widehat{K}_{AB} preserves the functional ξ_{AB} and changes the sign of ξ_{CD} . Hence, it multiplies their product by -1 .

The involution $\sigma_{K_{AB}}$ permutes the conics $BC \cup AD$ and $AC \cup BD$. Therefore, the functionals $\xi_{BC}, \xi_{AD}, \xi_{AC}, \xi_{BD}$ can be normalized so that the corresponding products $\xi_{BC}\xi_{AD}$ and $\xi_{AC}\xi_{BD}$ be permuted by \widehat{K}_{AB}^* with change of sign. Formula (4.2) is proved. Let us normalize ξ_{AB} and ξ_{CD} by constant factors (this does not change formula (4.2)) so that the analogue of the second formula in (4.2) holds for \widehat{K}_{BC}^* :

$$\widehat{K}_{BC}^*(\xi_{AC}\xi_{BD}) = -\xi_{AB}\xi_{CD}. \quad (4.3)$$

(The first formula in (4.2) holds for \widehat{K}_{BC}^* automatically, as for \widehat{K}_{AB}^* .) This together with the second formula in (4.2) and involutivity of the operators \widehat{V}^* imply that

$$\widehat{K}_{BC}^* \widehat{K}_{AB}^*(\xi_{AC}\xi_{BD}) = -\widehat{K}_{BC}^*(\xi_{BC}\xi_{AD}) = \xi_{BC}\xi_{AD}. \quad (4.4)$$

Replacing the right-hand side in (4.3) by $\widehat{K}_{AB}^*(\xi_{AB}\xi_{CD})$, applying \widehat{K}_{BC}^* to both sides, denoting $H := \widehat{K}_{BC}^* \widehat{K}_{AB}^*$, together with (4.4) yield

$$H(\xi_{AB}\xi_{CD}) = \xi_{AC}\xi_{BD}, \quad H(\xi_{AC}\xi_{BD}) = \xi_{BC}\xi_{AD}. \quad (4.5)$$

One also has

$$H(\xi_{BC}\xi_{AD}) = \xi_{AB}\xi_{CD}, \quad (4.6)$$

since $H^3 = Id$, by (4.1). Therefore,

$$\xi_{AC}\xi_{BD} + \xi_{BC}\xi_{AD} + \xi_{AB}\xi_{CD} = 0 \quad (4.7)$$

since the terms in the latter sum form an orbit of order three linear operator acting on a two-dimensional space W . Let us now prove the analogues of formula (4.2) for the other K_{EL} . To this end, let us show that

$$\widehat{K}_{CD}^* = \widehat{K}_{AB}^* \quad \text{on the space } W. \quad (4.8)$$

Indeed, the composition $\sigma_{K_{CD}} \circ \sigma_{K_{AB}}$ fixes the three singular conics (and hence, each conic of the pencil), by definition. Therefore, $\widehat{K}_{CD}^* = \widehat{K}_{AB}^*$ on W , up to constant factor. The latter constant factor is equal to one, since the operators in question take equal value at $\xi_{AB}\xi_{CD}$, by the first formula in (4.2) (which holds for K_{AB} replaced by K_{CD}). This proves (4.8). Formula (4.8) together with the other similar formulas, and already proved formula (4.2) for the operators \widehat{K}_{AB}^* , \widehat{K}_{BC}^* imply the analogues of (4.2) for \widehat{K}_{CD}^* , \widehat{K}_{DA}^* . Let us prove its analogue for \widehat{K}_{AC}^* . One has

$$\widehat{K}_{BC}^* \widehat{K}_{AC}^*(\xi_{AC}\xi_{BD}) = -\widehat{K}_{BC}^*(\xi_{AC}\xi_{BD}) = \xi_{AB}\xi_{CD}, \quad (4.9)$$

by formula (4.2) for K_{BC} . Therefore, $\xi_{AC}\xi_{BD}$, $\xi_{AB}\xi_{CD}$ together with a third vector $\widehat{K}_{BC}^* \widehat{K}_{AC}^*(\xi_{AB}\xi_{CD})$ form an orbit of order three linear operator $\widehat{K}_{BC}^* \widehat{K}_{AC}^*$ acting on W , see (4.1). The sum of vectors in the orbit should be equal to zero. This together with (4.7) implies that

$$\widehat{K}_{BC}^* \widehat{K}_{AC}^*(\xi_{AB}\xi_{CD}) = \xi_{BC}\xi_{AD}.$$

Applying \widehat{K}_{BC}^* to this equality yields $\widehat{K}_{AC}^*(\xi_{AB}\xi_{CD}) = -\xi_{BC}\xi_{AD}$. Formula (4.2) for K_{AC} is proved. For K_{BD} it follows from its version for K_{AC} as above. Formula (4.2) is proved for all K_{EL} . Proposition 4.2 is proved. \square

Claim. *Formula (4.2) holds, if and only if formula (1.23), i.e., (4.7) holds. Relation (4.7) determines the collection of products $\xi_{EL}\xi_{FN}$ uniquely up to common constant factor.*

Proof Formula (4.2) implies (4.7), as was shown above. The converse follows from the uniqueness statement of the claim, which in its turn follows from two-dimensionality of the ambient space W . \square

Proof of Theorem 1.32. Let the linear functionals ξ_{EL} be normalized to satisfy (1.23), which is possible by Proposition 4.2 and the above claim. Then they satisfy (4.2), by the claim. Projective transformations act on rational functions, which can be represented as rational 0-homogeneous functions of $Y = (y_1, y_2, y_3)$. The ratio $\frac{\xi_{AB}\xi_{CD}}{\xi_{BC}\xi_{AD}}$ is sent by $\sigma_{K_{AB}}$ to $\frac{\xi_{AC}\xi_{BD}}{\xi_{AC}\xi_{BD}}$ etc., by (4.2). This implies invariance of the degree 12 rational function (1.24) under all the involutions $\sigma_{K_{EL}}$. Its invariance under the involutions corresponding to the standard vertices follows from Proposition 4.2, Statement 1). Thus, the integral in question is invariant under the involutions of all the admissible vertices. It is invariant under the involution of tangent line to a conic of the multibilliard, since so are its factors, which are constant on the conics of the pencil. Theorem 1.32 is proved. \square

4.2 Dual pencil billiards. Proof of Theorem 1.46 and Lemma 1.47

Proof of Theorem 1.46. Consider a dual pencil type projective billiard given by a dual pencil of conics tangent to four distinct lines a, b, c, d . Consider the corresponding dual multibilliard in $\mathbb{RP}^2_{[\mathcal{M}_1:\mathcal{M}_2:\mathcal{M}_3]}$ obtained by orthogonal polarity duality. It is of pencil type, defined by the pencil of conics through the points A, B, C, D dual to the latter lines. Expression (1.27) considered as a rational 0-homogeneous function of \mathcal{M} is a well-defined function on \mathbb{RP}^2 . It is an integral of the multibilliard, provided that relation (1.26) holds (Theorem 1.32). There indeed exist $\chi_{em;fn}$ satisfying (1.26), by Theorem 1.32 and since each scalar product $\langle r(en), \mathcal{M} \rangle$ is a linear functional vanishing on the two-dimensional subspace $\pi^{-1}(EN) \subset \mathbb{R}^3$ corresponding to the line $EN: r(en) \perp \pi^{-1}(EN)$, by orthogonal polarity duality. Thus, substituting $\mathcal{M} = [r, v]$ to (1.27) yields an integral of the projective billiard, by Proposition 3.3, Statement 3). Theorem 1.46 is proved. \square

Proof of Lemma 1.47. Let us find $\chi_{em;fn}$ from linear equations implied by (1.26). Substituting $\mathcal{M} = (0, 0, 1)$ to (1.26) yields

$$\sum \chi_{em;fn} = 0. \quad (4.10)$$

For every intersection point em set

$$x(em) := (x_1(em), x_2(em)) \in \mathbb{R}^2.$$

Let now $\mathcal{M} \perp r(ab)$. Then there exists a $v = (v_1, v_2, 0)$ such that

$$\mathcal{M} = [r(ab), v] = (-v_2, v_1, \Delta_{ab}), \quad \Delta_{ab} := [x(ab), (v_1, v_2)] = x_1(ab)v_2 - x_2(ab)v_1, \quad (4.11)$$

since $v \mapsto [r, v]$ is a linear isomorphism $\mathbb{R}^2 \rightarrow r^\perp$. Substituting (4.11) to (1.26) yields

$$\chi_{bc;ad}[x(bc) - x(ab), v][x(ad) - x(ab), v]$$

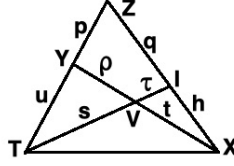

Figure 19:

$$+ \chi_{ac;bd}[x(ac) - x(ab), v][x(bd) - x(ab), v] = 0. \quad (4.12)$$

The vector differences $x(bc) - x(ab)$, $x(bd) - x(ab)$ in (4.12) are proportional (being parallel to the line b), and so are the other vector differences (parallel to a). Therefore, equality (4.12) is equivalent to the relation

$$\chi_{bc;ad}\rho\tau + \chi_{ac;bd}st = 0. \quad (4.13)$$

Combining (4.13) with (4.10) and normalizing the $\chi_{em;fn}$ so that $\chi_{ac;bd} = 1$ yields (1.29). Lemma 1.47 is proved. \square

Remark 4.3 The $\chi_{em;fn}$ satisfying (1.26) can be also found by all the possible substitutions $\mathcal{M} \perp r(em)$ for $em = ab, bc, cd, ac, bd, ad$. This yields a system of linear equations. It appears that their matrix has rank two, so that there exists a unique common non-zero solution. Namely, all the 3x3-minors vanish. This follows from two-dimensionality of the subspace W generated by the three quadratic forms $\langle r(em), \mathcal{M} \rangle \langle r(fn), \mathcal{M} \rangle$, which in its turn follows from the fact that *the three singular conics $AB \cup CD$, $AC \cup BD$, $AD \cup BC$ formed by the lines EM dual to the points em lie in the same pencil of conics through the points A, B, C, D* . On the other hand, a direct calculation of 3x3-minors of the matrix of linear equations and equating these minors to zero yields relations on the (oriented) lengths $s, \tau, \rho, t, p = |cd - bc|$, $u = |bc - ac|$, $q = |cd - ad|$, $h = |ad - bd|$, see Fig. 15. These relations are given by the following geometric theorem, which can also be deduced from Sine Theorem. The author believes that this theorem is well-known, but he did not found a reference to it.

Theorem 4.4 *In a triangle XZT , see Fig. 19, let us take arbitrary points Y, I on its sides ZT and XZ respectively. Let V denote the intersection point of the lines XY and TI . Set*

$$\rho := |YV|, \quad t := |VX|, \quad s := |TV|, \quad \tau := |VI|,$$

$$u := |TY|, \quad p := |YZ|, \quad q := |IZ|, \quad h := |XI|.$$

Then

$$\frac{pq}{(p+u)(q+h)} = \frac{\rho\tau}{st}, \quad \frac{tp}{(\rho+t)(p+u)} = \frac{\tau}{s+\tau}, \quad \frac{sq}{(s+\tau)(q+h)} = \frac{\rho}{\rho+t}.$$

4.3 Generic dual pencil billiards with integrals of degrees 4 and 12

Let us construct explicit examples of dual pencil type projective billiards with minimal degree of integral being equal to 4 and 12, with non-degenerate dual pencil. Consider a dual pencil of conics tangent to four given distinct lines: a, b, c, d . Fix some its conic γ . We consider that it is a closed curve in \mathbb{R}^2 . Let us equip it with the projective billiard structure defined by the pencil: the conics of the pencil are its complex caustics. Let us construct the corresponding admissible lines m_1, m_2, m_3 and $k_{ef}, e, f \in \{a, b, c, d\}, e \neq f$, equipped with their central projective billiard structures. We consider that the intersection points ab, bc, cd, da of the tangent lines form a convex quadrilateral in which γ is inscribed. Then the lines k_{ac} and k_{bd} both intersect the convex domain bounded by γ , see Figures 20 and 21.

Example 4.5 of projective billiards with integral of degree 4. The line k_{ac} cuts the domain bounded by γ into two pieces. Each of them is a projective billiard bounded by an arc of the curve γ and a segment of the line k_{ac} , both equipped with the corresponding projective billiard structures. Both these projective billiards are rationally integrable with minimal degree of integral equal to four (Theorems 1.43 and 1.44). See Fig. 20. However the tangency points (marked in bold) of the curve γ with the lines a, b, c, d are indeterminacy points of the projective billiard structure on γ . But in each piece we can split its boundary arc lying in γ into open subarcs separated by the tangency points. The projective billiard structure is well-defined on the latter subarcs, and we can consider them as smaller smooth pieces of the boundary. A way to exclude the indeterminacy points from the boundary is to cut by the line m_2 and to consider a smaller domain, bounded by segments of the lines k_{ac}, m_2 and an arc of the curve γ , now without indeterminacies on smooth boundary arcs (except for the "corners"). This yields a curvilinear triangle equipped with a projective billiard structure, also admitting a rational integral of minimal degree 4.

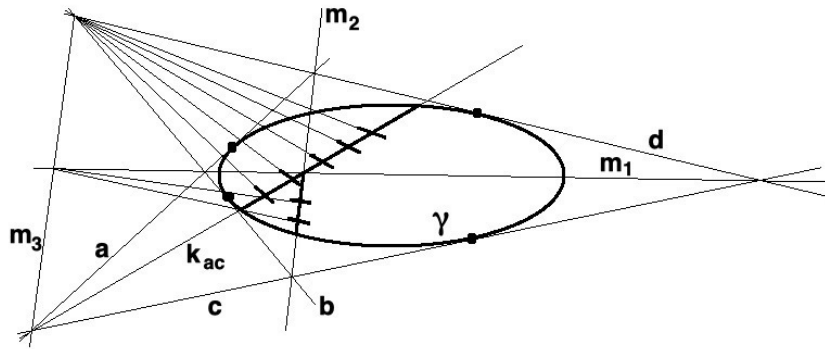

Figure 20: Three projective billiards (with boundaries marked in bold) with rational integral of minimal degree 4. The indeterminacies of the projective billiard structure on γ are marked in bold.

Example 4.6 with integral of degree 12. Consider the two curvilinear quadrilaterals with boundaries marked in bold at Fig. 21 as projective billiards. The first one is bounded by segments of the lines k_{ad} , k_{bd} , m_2 and an arc of the conic γ . The second one is bounded by segments of the lines k_{bd} , k_{ab} , k_{ac} and an arc of the conic γ . (We need to note that the boundary arc in γ in at least some of them contains (at least one) tangency point, which is an indeterminacy point of the projective billiard structure.) Both quadrilaterals considered as projective billiards are rationally integrable with minimal degree of integral being equal to 12, by Theorems 1.43 and 1.44.

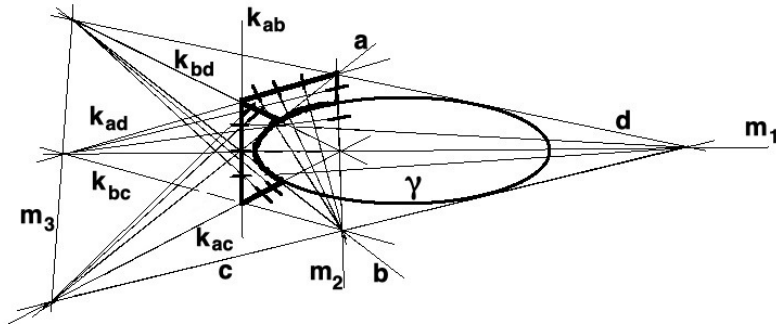

Figure 21: Two projective billiards (with boundaries marked in bold) with integral of minimal degree 12.

4.4 Semi-(pseudo-) Euclidean billiards with integrals of different degrees

Definition 4.7 A projective billiard in \mathbb{R}_{x_1, x_2}^2 with piecewise smooth boundary is called *semi-Euclidean (semi-pseudo-Euclidean)*, if the nonlinear part of the boundary, i.e., its complement to the union of straightline intervals contained there, is equipped with normal line field for the Euclidean metric $dx_1^2 + dx_2^2$ (respectively, for the pseudo-Euclidean metric $dx_1^2 - dx_2^2$).

Theorem 4.8 A semi-Euclidean billiard is rationally 0-homogeneously integrable, if and only if the nonlinear part of its boundary is a finite union of confocal conical arcs and segments of some of the **admissible real lines** (listed below) for the corresponding confocal pencil of conics:

Case 1), pencil of confocal ellipses and hyperbolas:

- standard lines: the two symmetry axes of the ellipses, equipped with normal line field;
- skew lines: the lines L_1, L_2 through the foci F_1, F_2 , orthogonal to the line F_1F_2 , each L_j is equipped with the field of lines through the other focus F_{2-j} .

The billiard has quadratic integral, if and only if its boundary contains no segments of lines $L_{1,2}$; otherwise the minimal degree of integral is four.

Case 2), pencil of confocal parabolas:

- the standard line: the common axis of the parabolas;

- the skew line: the line L through the focus that is orthogonal to the axis.

Both lines are equipped with the normal line field. The billiard has quadratic integral, if and only if its boundary contains no segments of the line L ; otherwise the minimal degree of integral is four.

Proof The other admissible lines from Definition 1.38 are not finite real lines. For example, in Case 1) the dual pencil of confocal conics consists of conics tangent to two given pairs of lines through the two isotropic points $[1 : \pm i : 0]$ at infinity. In this case the only real skew admissible lines are the lines L_1 and L_2 , and they are opposite as skew admissible lines: they correspond to two opposite intersection points of the above tangent lines, namely, the foci F_1 and F_2 . Similarly in Case 2) the only real skew admissible line is L . This together with Theorem 1.44 proves Theorem 4.8. \square

Example 4.9 Consider an ellipse and a line L_1 through its left focus F_1 that is orthogonal to the foci line. See Fig. 22, the left part. Consider the dashed domain bounded by the intersection segment of the line L_1 with the ellipse interior and the left elliptic arc; the latter arc is equipped with normal line field, and the segment with the field of lines through the other focus F_2 . This projective billiard admits a rational 0-homogeneous integral of minimal degree four (Theorem 4.8). As the second focus F_2 tends to infinity so that the ellipse tends to a parabola with the focus $F = F_1$, the above billiard converges to a usual billiard (with normal line field) bounded by a segment of the line L through F orthogonal to the parabola axis and by a parabola arc. See the right part of Fig. 22. The latter parabolic billiard is known to have a polynomial integral of minimal degree four (and hence, a rational 0-homogeneous integral of degree four, see also Theorem 4.8). It was first discovered in [38].

Proposition 4.10 *The projective billiards with rational 0-homogeneous integral of minimal degrees 4 and 12 presented at Fig. 20 and 21 respectively are realized by semi-pseudo-Euclidean billiards in $(\mathbb{R}^2, dx_1^2 - dx_2^2)$.*

Proof Take the points $bd = b \cap d$ and $ac = a \cap c$ to be the isotropic points at infinity $[1 : \pm 1 : 0]$. \square

5 Acknowledgments

I wish to thank Sergei Tabachnikov for introducing me to projective billiards and helpful discussions. I wish to thank Sergei Bolotin, Valery Kozlov, Constantin Shramov, Dmitry Treschev, Suzanna Zimmermann, Julie Deserti, Frédéric Mangolte for helpful discussions.

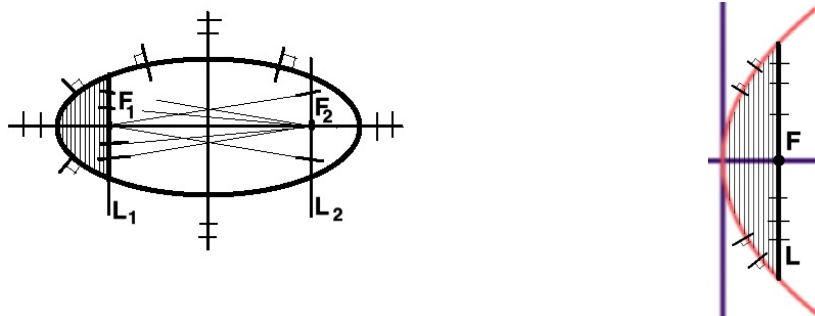

Figure 22: Billiards (dashed) with degree 4 integrals. On the left: the semi-Euclidean billiard bounded by a segment of the line L_1 and an elliptic arc. As the ellipse degenerates to a horizontal parabola, it tends to the Euclidean billiard on the right discovered in [38], with a degree 4 polynomial integral.

References

- [1] Avila, A.; De Simoi, J.; Kaloshin, V. *An integrable deformation of an ellipse of small eccentricity is an ellipse*. Ann. of Math. (2) **184** (2016), No. 2, 527–558.
- [2] Amiran, E. *Caustics and evolutes for convex planar domains*. J. Diff. Geometry, **28** (1988), 345–357.
- [3] Berger, M. *Geometry, I*. Universitext, Springer, Berlin, 1987. Translated from the French by M. Cole and S. Levy.
- [4] Bialy, M. *Convex billiards and a theorem by E. Hopf*. Math. Z., **214(1)** (1993), 147–154.
- [5] Bialy, M. *On totally integrable magnetic billiards on constant curvature surface*. Electron. Res. Announc. Math. Sci. **19** (2012), 112–119.
- [6] Bialy, M. *Hopf rigidity for convex billiards on the hemisphere and hyperbolic plane*. Discrete Contin. Dyn. Syst. **33** (2013), No. 9, 3903–3913.
- [7] Bialy, M.; Mironov, A. *On fourth-degree polynomial integrals of the Birkhoff billiard*. Proc. Steklov Inst. Math., **295** (2016), No. 1, 27–32.
- [8] Bialy, M.; Mironov, A.E. *Algebraic non-integrability of magnetic billiards*. J. Phys. A **49** (2016), No. 45, 455101, 18 pp.
- [9] Bialy, M.; Mironov, A. *Angular billiard and algebraic Birkhoff conjecture*. Adv. in Math. **313** (2017), 102–126.

- [10] Bialy, M.; Mironov, A. *Algebraic Birkhoff conjecture for billiards on Sphere and Hyperbolic plane*. J. Geom. Phys., **115** (2017), 150–156.
- [11] Bialy, M.; Mironov, A.E. *Polynomial non-integrability of magnetic billiards on the sphere and the hyperbolic plane*. Russ. Math. Surveys, **74** (2018), 187–209.
- [12] Bialy, M.; Mironov, A.E. *A survey on polynomial in momenta integrals for billiard problems*. Phil. Trans. R. Soc. A., **336** (2018), Issue 2131, <https://doi.org/10.1098/rsta.2017.0418>
- [13] Bialy, M.; Mironov, A.E. *The Birkhoff-Poritsky conjecture for centrally-symmetric billiard tables*. Ann. of Math. (2) **196** (1) (2022), 389–413.
- [14] Blanc, J. *The number of conjugacy classes of elements of the Cremona group of some given finite order*. Bull. Soc. Math. France, **135** (3) (2007), 419–434.
- [15] Bolotin, S.V. *Integrable Birkhoff billiards*. Mosc. Univ. Mech. Bull. **45**:2 (1990), 10–13.
- [16] Bolotin, S.V. *Integrable billiards on surfaces of constant curvature*. Math. Notes **51** (1992), No. 1–2, 117–123.
- [17] Chang, S.J.; Crespi, B.; Shi, K.J. *Elliptical billiard systems and the full Poncelet’s theorem in n dimensions*. J. Math. Phys. **34**, 2242 (1993).
- [18] Dragović, V.; Radnović, M. *Integrable billiards and quadrics*. Russian Math. Surveys **65** (2010), No. 2, 319–379.
- [19] Dragović, V.; Radnović, M. *Bicentennial of the great Poncelet theorem (1813–2013): current advances*. Bull. Amer. Math. Soc. (N.S.) **51** (2014), No. 3, 373–445.
- [20] Dragović, V.; Radnović, M. *Pseudo-integrable billiards and arithmetic dynamics*. J. Mod. Dyn. **8** (2014), No. 1, 109–132.
- [21] Dragović, V.; Radnović, M. *Periods of pseudo-integrable billiards*. Arnold Math. J. **1** (2015), No. 1, 69–73.
- [22] Dragović, V.; Radnović, M. *Pseudo-integrable billiards and double reflection nets*. Russian Math. Surveys **70** (2015), No. 1, 1–31.
- [23] Fierobe, C. *Projective and complex billiards, periodic orbits and Pfaffian systems*. PhD thesis, ENS de Lyon, 2021. Preprint <https://tel.archives-ouvertes.fr/tel-03267693>
- [24] Fierobe, C. *On projective billiards with open subsets of triangular orbits*. To appear in Israel J. of Math. Preprint <https://arxiv.org/abs/2005.02012>
- [25] Fierobe, C. *Examples of reflective projective billiards and outer ghost billiards*. Preprint <https://arxiv.org/abs/2002.09845>

- [26] Glutsyuk, A.; Shustin, E. *On polynomially integrable planar outer billiards and curves with symmetry property*. Math. Annalen, **372** (2018), 1481–1501.
- [27] Glutsyuk, A.A. *On two-dimensional polynomially integrable billiards on surfaces of constant curvature*. Doklady Math., **98** (2018), No. 1, 382–385.
- [28] Glutsyuk, A.A. *On polynomially integrable Birkhoff billiards on surfaces of constant curvature*. J. Eur. Math. Soc. **23** (2021), 995–1049.
- [29] Glutsyuk, A. *On infinitely many foliations by caustics in strictly convex open billiards*. Erg. Th. Dyn. Sys. doi:10.1017/etds.2023.42
Preprint version: <https://arxiv.org/abs/2104.01362>
- [30] Glutsyuk, A. *On rationally integrable planar dual and projective billiards*. Preprint <https://arxiv.org/abs/2112.07056>
- [31] Kaloshin, V.; Sorrentino, A. *On local Birkhoff Conjecture for convex billiards*. Ann. of Math., **188** (2018), No. 1, 315–380.
- [32] V. Kaloshin, A. Sorrentino. *On the integrability of Birkhoff billiards*. Philos. Trans. Roy. Soc. A **376** (2018), No. 2131, 20170419, 16 pp.
- [33] Koval, Ilya. *Local strong Birkhoff conjecture and local spectral rigidity of almost every ellipse*. Preprint <https://arxiv.org/abs/2111.12171>
- [34] Kozlov, V.V.; Treshchev, D.V. *Billiards. A genetic introduction to the dynamics of systems with impacts*. Translated from Russian by J.R.Schulenberger. Translations of Mathematical Monographs, **89**, American Mathematical Society, Providence, RI, 1991.
- [35] Lazutkin, V.F. *The existence of caustics for a billiard problem in a convex domain*. Math. USSR Izvestija **7** (1973), 185–214.
- [36] Marco, J.-P. *Entropy of billiard maps and a dynamical version of the Birkhoff conjecture*. J. Geom. Phys., **124** (2018), 413–420.
- [37] Poritsky, H. *The billiard ball problem on a table with a convex boundary – an illustrative dynamical problem*. Ann. of Math. (2) **51** (1950), 446–470.
- [38] Ramani, A.; Kalliterakis, A.; Grammaticos, B.; Dorizzi, B. *Integrable curvilinear billiards*. Phys. Lett. A, **115** (1986), No. 1–2, 25–28.
- [39] Tabachnikov, S. *Introducing projective billiards*. Ergod. Th. Dynam. Sys. **17** (1997), 957–976.
- [40] Tabachnikov, S. *On algebraically integrable outer billiards*. Pacific J. of Math. **235** (2008), No. 1, 101–104.
- [41] Treschev, D. *Billiard map and rigid rotation*. Phys. D., **255** (2013), 31–34.

- [42] Treschev, D. *On a Conjugacy Problem in Billiard Dynamics*. Proc. Steklov Inst. Math., **289** (2015), No. 1, 291–299.
- [43] Treschev, D. *A locally integrable multi-dimensional billiard system*. Discrete Contin. Dyn. Syst. **37** (2017), No. 10, 5271–5284.
- [44] Veselov, A. P. *Integrable systems with discrete time and difference operators*. Funct. Anal. Appl. **22** (1988), No. 2, 83–93.
- [45] Veselov, A.P. *Confocal surfaces and integrable billiards on the sphere and in the Lobachevsky space*. J. Geom. Phys., **7** (1990), Issue 1, 81–107.
- [46] Wojtkowski, M.P. *Two applications of Jacobi fields to the billiard ball problem*. J. Differential Geom. **40** (1) (1994), 155–164.